

#51

Raptor-4G

By AirDog®

RP-100-4G

RP-150-4G

PATENT PROTECTED:

<https://pureflowairdog.com/p-35853-patents.html>

2011-2014

DURAMAX DIESEL

INSTALLATION INSTRUCTIONS

PLEASE READ AND CHECK CONTENTS

BEFORE INSTALLATION



PUREFLOW AIRDOG
705 W MAUSOLEUM RD.
SHELBYVILLE, IN 46176

877-421-3187
PUREFLOWAIRDOG.COM

Raptor-4G By AirDog®



THE FITTINGS THAT ARE INCLUDED ARE FOR INSIDE FRAME RAIL MOUNTING

TABLE OF CONTENTS

| SECTION | DESCRIPTION | PAGE |
|----------------|-------------------------------------|-------------|
| 1 | TABLE OF CONTENTS | 3 |
| 2 | INTRODUCTION | 4 |
| 3 | SAFETY GUIDELINES | 5 |
| 4 | PRE-INSTALLATION CHECKS | 6 |
| 5 | PARTS LIST | 7 |
| 6 | BOLT KIT PARTS LIST | 8 |
| 7 | SYSTEM ILLUSTRATION | 9 |
| 8 | PUMP FITTING INSTALLATION | 10 |
| 9 | MOUNTING THE RAPTOR-4G | 11 |
| 10 | FUEL LINE ASSEMBLY | 13 |
| 11 | SUPPLY LINE TO THE FUEL FILTER HEAD | 14 |
| 12 | SUCTION LINE FROM THE TANK | 16 |
| 13 | WIRING HARNESS INSTALLATION | 17 |
| 14 | INITIAL START PROCEDURE | 21 |
| 15 | ADJUSTING THE FUEL PRESSURE | 22 |
| 16 | SERVICE AND TROUBLESHOOTING | 23 |
| 17 | LIMITED LIFETIME WARRANTY | 25 |

Thank you for your purchase and welcome to PureFlow AirDog's **Raptor-4G** fuel lift pump for the 2011-2014 Duramax diesel engine.

The Raptor-4G is a premium fuel pump that incorporates PureFlow AirDog's 4G quiet and smooth running four bearing design. This fuel system requires no return line as the fuel is internally regulated. The fuel is delivered to the engine at the correct pressure and flow rate to meet the demands of the engine under all operating conditions.

Pressure and flows are approximate as they will vary with fuel temperature and as the brushes wear in. The pressure will also vary per application through variation of vehicle voltage/amp output and fuel line installation. It is recommended to install a fuel pressure gauge before the truck is started for the first time to verify fuel pressure.

The Raptor-4G systems feature a built in adjustable pressure regulator. All Raptor-4G systems include a complete installation kit.

The Raptor-4G for this particular application is preset at 8-10psi from factory for a stock application. The regulator is adjustable up to 75psi for fine tuning the system for performance upgrades. **WARNING: BECAUSE YOU CAN TURN UP THE FUEL PRESSURE DOESN'T MEAN YOU SHOULD. MORE PRESSURE DOES NOT MEAN MORE FLOW. MORE PRESSURE MEANS LESS FLOW. YOU SHOULD SET FUEL PRESSURE PER PERFORMANCE UPGRADE RECOMMENDATIONS ONLY.**

PureFlow AirDog® products are manufactured in Shelbyville Indiana by a team of skilled workers with unsurpassed attention to detail and using the most stringent quality assurance.

TYPICAL DURAMAX INSTALLATION LAYOUT:

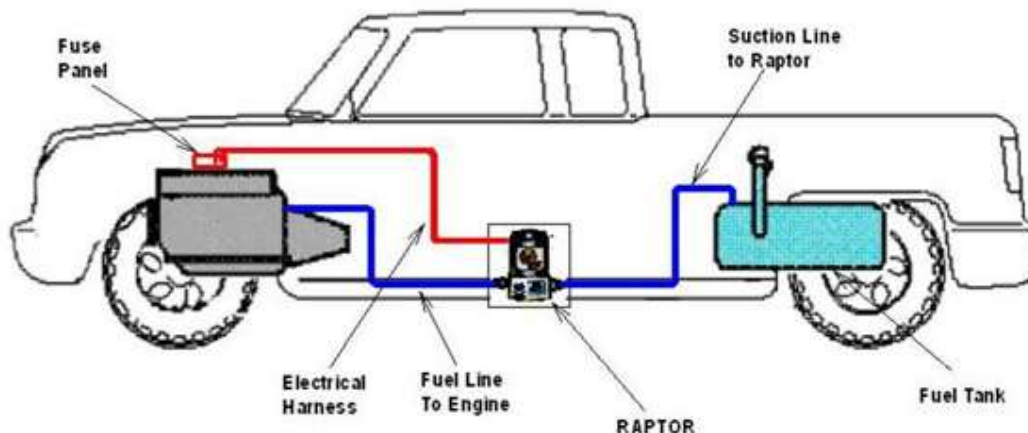

NOTICE

The pictures used in this manual are for example only and may not be exactly the same as your truck.

! IMPORTANT!

PLEASE READ THIS INSTALLATION MANUAL CAREFULLY

It contains important information, instructions, and necessary operating procedures. The continual observance of the operating procedures will help extend the life of the fuel system.



SAFETY INSTRUCTIONS

LEARN TO RECOGNIZE SAFETY INFORMATION

This is the safety alert symbol. When you see this symbol in this manual, **BE ALERT TO THE POTENTIAL FOR PERSONAL INJURY!**

Follow recommended precautions and safe operating practices.



UNDERSTANDING SIGNAL WORDS

A signal word-**DANGER**, **WARNING**, or **CAUTION** is used with the safety alert symbol.

DANGER indicates a hazardous situation which, if not avoided, **WILL** result in death or serious injury.



WARNING indicates a hazardous situation which if not avoided, **COULD** result in death or serious injury.



CAUTION indicates a hazardous situation which if not avoided, **COULD** result in minor or moderate injury



NOTICE indicates a preferred installation procedure





WARNING: SUFFOCATION HAZARD! Immediately discard any plastic bags and packing materials to eliminate **CHOKING HAZARDS TO CHILDREN AND ANIMALS.**

The installation of your AirDog® can be made relatively easy by following the steps outlined in this manual, and:

1. Inventory the package components completely. Notify PUREFLOW AIRDOG® immediately of any missing or damaged parts! 317-421-3180
2. Read the installation manual completely. Understand how the system operates and understand the installation recommendations before beginning the installation.
3. The installation recommendations contained herein are suggested installation guidelines only. Individual installations may vary.
4. If any installation procedure is uncertain, contact PUREFLOW® AIRDOG for technical assistance.
5. When installing the AirDog® fuel lines be sure to keep the **ORIGINAL ENGINE RETURN LINE** connected as it is from the factory!

SAFETY GUIDELINES!

WARNING

Please be sure to chock the vehicle's tires to prevent rolling

WARNING

Please use proper supports when working beneath an elevated vehicle

CAUTION

Most diesel pickups have two (2) 12 volt batteries. Disconnect the battery cables to both batteries before proceeding with the AirDog® installation

WARNING

Vehicle main frameroils should not be drilled into or welded upon.

CAUTION

Wear safety glasses or shield when using tools such as drills and grinders or when using a punch or chisel



CAUTION











Prolonged exposure to loud noise can cause impairment or loss of hearing. Wear suitable hearing protective devices such as ear muffs or ear plugs to protect against loud noises.





CAUTION

Use common sense when routing fuel lines and electrical wiring. Keep them away from hot exhaust components and/or moving parts. Properly secure lines to prevent chaffing.

RAPTOR-4G PARTS LIST**(VERIFY YOU HAVE ALL THE CORRECT PARTS BEFORE BEGINNING THE INSTALLATION!)**

| QTY | DESCRIPTION | PART NUMBER | IMAGE |
|------------|--|------------------------------|---|
| 1 | RAPTOR-4G FUEL PUMP | RP-4G-100 OR RP-4G-150 |  |
| 1 | WIRING HARNESS | 5E-2-010-HD |  |
| 1 | CABLE TIE BUNDLE | 5H-2-1-B |  |
| 1 | HARDWARE KIT | 901-61-0102-RP-12 |  |
| 1 | 14FT FUEL LINE | HS14 |  |
| 1 | 1/2" FEMALE QUICK CONNECT TO 1/2" BARBED MALE FITTING | FQC12S |  |
| 1 | 11.8mm FEMALE QUICK CONNECT TO 1/2" BARBED MALE FITTING | FQC118S |  |
| 2 | 1/2" FEMALE QUICK CONNECT TO 1/2" BARBED MALE 90 DEG FITTING | FQC1290 |  |
| 1 | 1/2" MALE QUICK CONNECT TO 3/4-16 ORB ("IN" FITTING) | 08J2044-3/4UNF |  |
| 1 | 1/2" MALE QUICK CONNECT TO 9/16-18 ORB ("OUT" FITTING) | 08J2044916UNF |  |
| 1 | SERVICE O-RING KIT | 901-05-0102 |  |

901-61-0102-RP-12 Bolt Kit Parts List

| QTY | DESCRIPTION | IMAGE |
|-----|--------------------------------------|---|
| 4 | 5/16-18 X .75" SOCKET HEAD CAP SCREW |  |
| 4 | 5/16" SPLIT-LOCK WASHER |  |

SYSTEM ILLUSTRATION

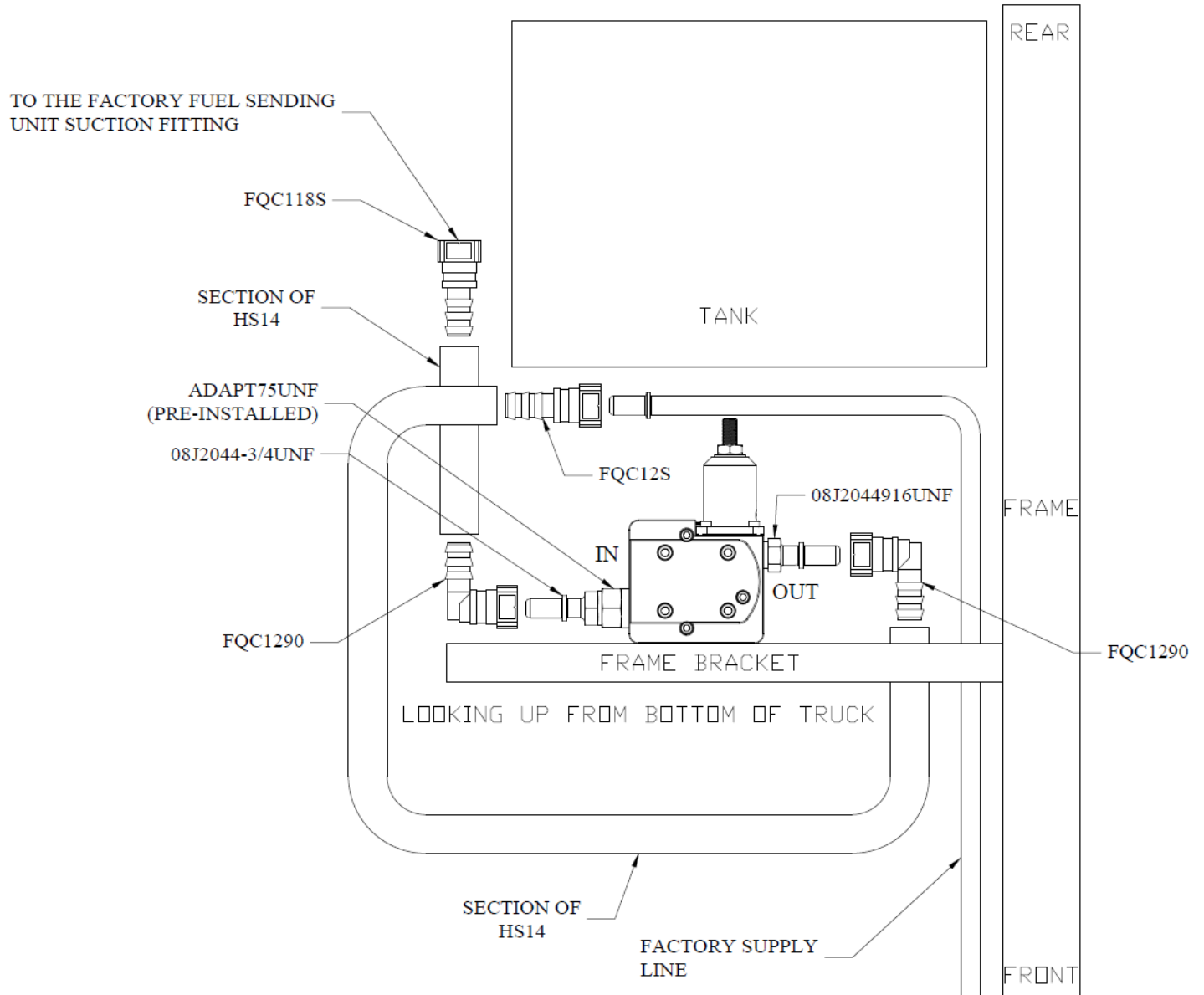

PUMP FITTING INSTALLATION

ITEMS NEEDED:

1. 08J2044-3/4UNF FITTING
2. 08J2044916UNF FITTING
3. TORQUE WRENCH
4. DEEP 3/4" SOCKET
5. DEEP 7/8" SOCKET

NOTICE

Do not overtighten the aluminum fittings or they may break! Torque specs are listed in red below. Broken fittings from mis-installation are not a warrantable item.

- 8-1. Install the 08J2044-3/4UNF fitting into the "IN" side of the fuel pump by, first, hand threading the fitting into the screen adapter. Then take the torque wrench with a 7/8" deep socket attached and **torque the fitting to 180in-lb or 15ft-lb**. Refer to figure 1 and 2.



Figure 1



Figure 2

- 8-2. Next, install the 08J2044916UNF fitting in the "OUT" port of the pump by, first, hand-threading the fitting in. Then, take the torque wrench with a 3/4" deep socket attached and **torque the fitting to 120in-lb or 10ft-lb**. Refer to figures 3 and 4.



Figure 3



Figure 4

MOUNTING THE RAPTOR-4G TO THE FRAME

ITEMS NEEDED:

1. PENCIL AND PAPER
 2. DRILL
 3. 3/8" DRILL BIT
 4. 1/4" ALLEN WRENCH
- 9-1. Make a paper template using the back of the raptor and a pencil as shown below in figures 5 and 6.



Figure 5



Figure 6

- 9-2. Transfer the mounting hole locations from the paper template to the frame jig using a center punch. Be sure to align the template in order to get the proper clearance needed when pump is installed.



Figure 7



9-3. After holes are marked drill (4) 3/8" holes for the mounting bolts.



Figure 8



Figure 9

9-4. Attach the completely assembled Raptor™ to the frame jig bracket using the supplied 5/16-18 cap screws and lock washers supplied in the mounting hardware kit. The pump installed should look similar to figures 10 and 11.

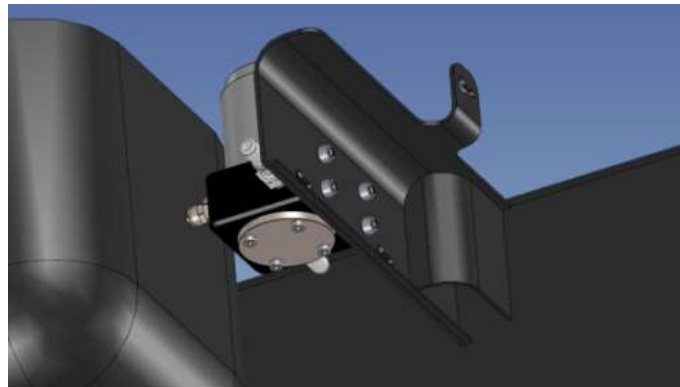

Figure 10

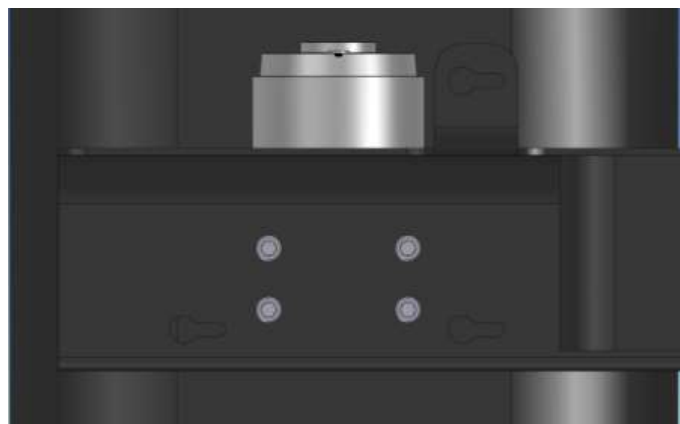

Figure 11

NOTICE

The photos shown above are of a previous model Raptor, but the Raptor-4G will install the same.

ASSEMBLING THE FUEL LINES

This kit includes a length of fuel line and separate fuel line fittings to allow for much cleaner looking installations! Assemble the fuel lines as you install them. You won't want to pre-assemble the hoses or your lengths may be off.

NOTICE

Hose clamps are not needed for these push-lock connectors. Hose clamps may cut the fuel line and cause leaks.

- 10-1. Take the fuel line end and lubricate the barbed end with clean motor oil (Figure 12) and press it into the fuel line (HS14) until all of the barbs are covered (Figures 13 and 14). The fuel line end should look like Figure 14 when properly pressed in.



Figure 12



Figure 13



Figure 14

- 10-2. Now plug that fuel line with that fitting into the connection on the either the Raptor or the truck where the manual calls it out.
- 10-3. Run the fuel line along the frame away from any hot or moving parts such as exhaust or the driveshaft (Figure 15). Cut the hose to length and insert the other fuel line end that the manual calls out into the fuel line as outlined in step 10-1.



Figure 15

NOTICE

There are two types of straight fuel fittings in this kit. One is standard (1/2in) and the other is metric (11.8mm). The metric fitting is used to connect to the factory suction line from the tank and is identified by both a red dot and the marking of 11.8 (Figure 16).



Figure 16

SUPPLY LINE TO ENGINE

ITEMS NEEDED

1. HS14 FUEL LINE
2. FQC1290
3. FQC12S
4. 1/2" QUICK CONNECT TOOL (SOLD SEPARATELY)

NOTICE

To install the Raptor-4G fuel supply line to the engine, you must first remove the (flexible) factory fuel line connecting the fuel tank to the frame mounted steel fuel line (Figure 19). It will be the larger of the two lines that are on the frame.

NOTICE

In some cases, the fuel tank connections are located behind the tank shield. It may be necessary to remove or bend the tank shield down to access the suction tube quick connect fitting.

- 11-1. Remove the factory fuel supply line from the fuel tank suction tube. Place the 1/2" fuel line disconnect tool around the fuel line and press into the Quick Connect fitting to release the locks. Carefully pull the factory quick connect fitting and fuel line from the fuel tank suction fitting.



Figure 17

The DISCONNECT TOOL (as seen below) can be purchased from your local auto parts store. **This tool is NOT included in the kit.**



Figure 18

- 11-2. Disconnect the other end of the fuel supply line from the steel line using the disconnect tool. It is the larger of the two lines on the frame. This connection is located between the frame bracket and the front of the fuel tank. You may now remove the factory flex line (Figure 20).

Figure 19



Figure 20



- 11-3. Assemble one end of the hose (Reference section 10) using fuel line fitting FQC12S and plug it into the factory fuel line on the frame to where the factory flex line was removed in step 11-2. A “click” will be heard once the fitting is properly connected.

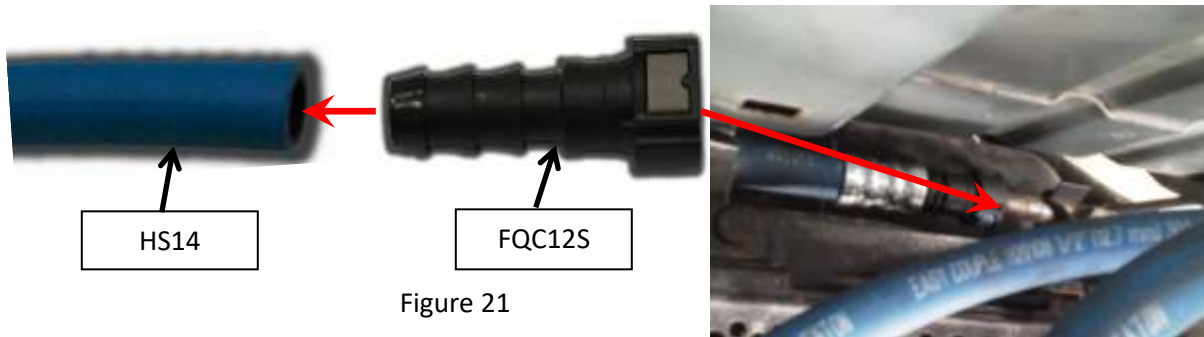

- 11-4. Run the fuel line along the frame as mentioned in step 10-3 to the “OUT” port in the Raptor-4G. Cut the fuel line to length and insert fuel line end FQC1290 per step 10-1. Once the connector is installed, connect it to the male J2044 fitting in the “OUT” port in the Raptor-4G. A “click” will be heard once properly connected.

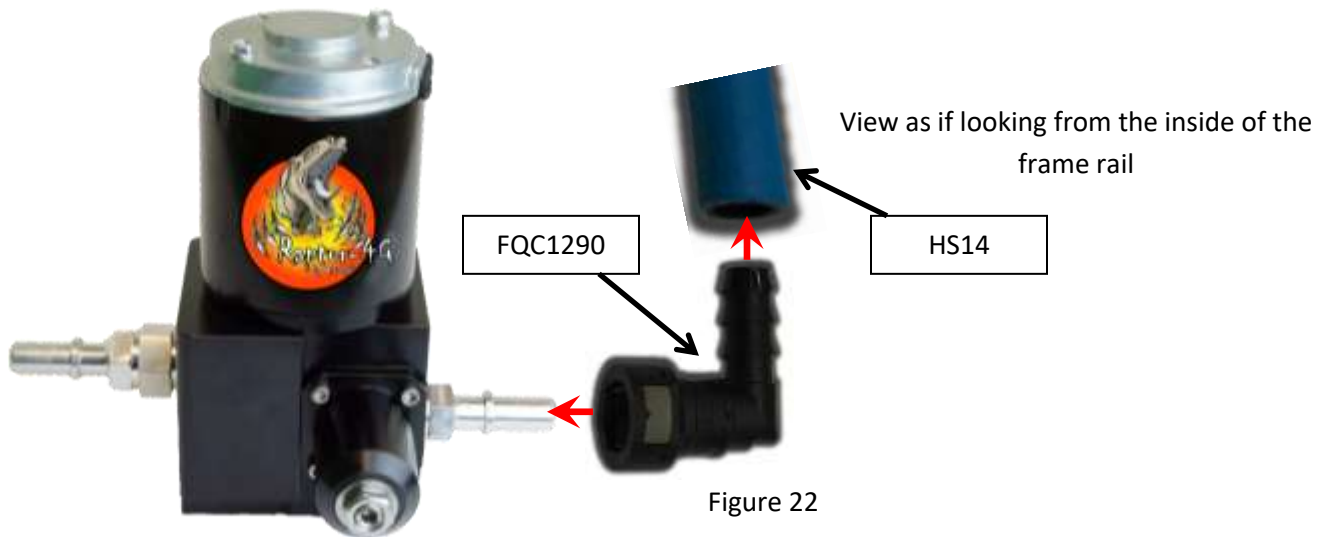

- 11-5. Once the fuel line is routed and connected, you may use the cable ties (5H-1-2-B) to securely fasten the fuel line to the frame. Remember to keep it away from any hot or moving parts such as exhaust piping and driveshafts.

SUCTION LINE FROM THE TANK TO THE RAPTOR-4G

ITEMS NEEDED:

1. FQC12S
2. FQC118S
3. HS14 REMAINING SECTION

- 12-1. Assemble one end of the fuel line (Reference section 10) using fuel line end FCQ118S and plug it into the male connection to where the factory suction line was just removed at the tank (11-1). A “click” will be heard once properly connected.



Figure 23

- 12-2. Run the fuel line along the frame as mentioned in step 10-3 to the Raptor-4G “IN” port. Cut the fuel line to length and insert fuel line connector FQC12S per step 10-1. Once the fuel line end is pressed in, connect it to the male J2044 fitting in the Raptor® “In” port. A “click” will be heard once properly connected.

View as if looking from the inside of the frame rail

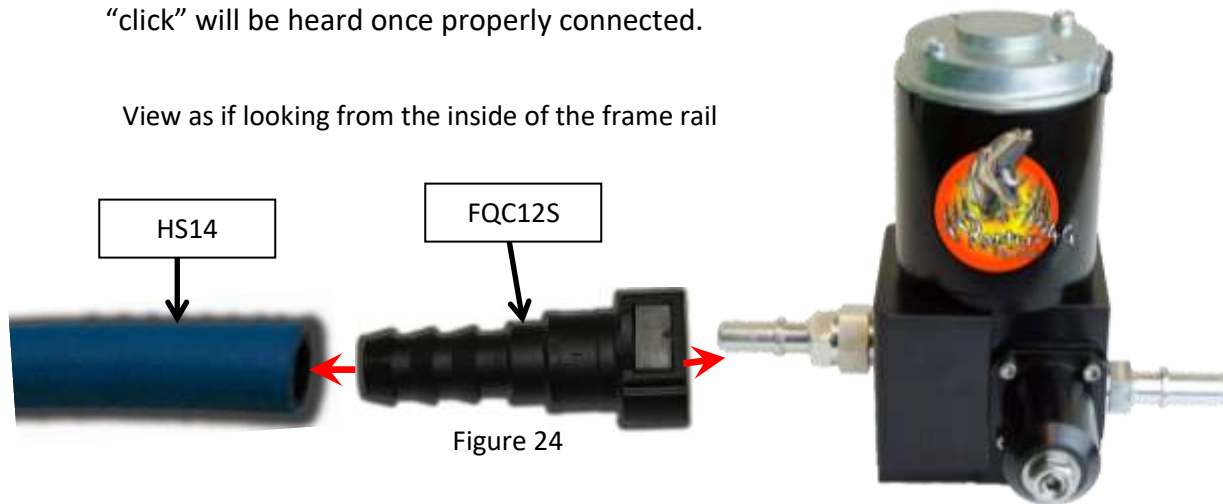

Figure 24

- 12-3. Once the fuel line is routed and connected, you may use the cable ties (5H-1-2-B) to securely fasten the fuel line to the frame. Remember to keep it away from any hot or moving parts such as exhaust piping and driveshafts.

WIRING HARNESS ROUTING AND INSTALLATION

ITEMS NEEDED:

1. 5E-2-010-HD WIRING HARNESS

WIRING DIAGRAM

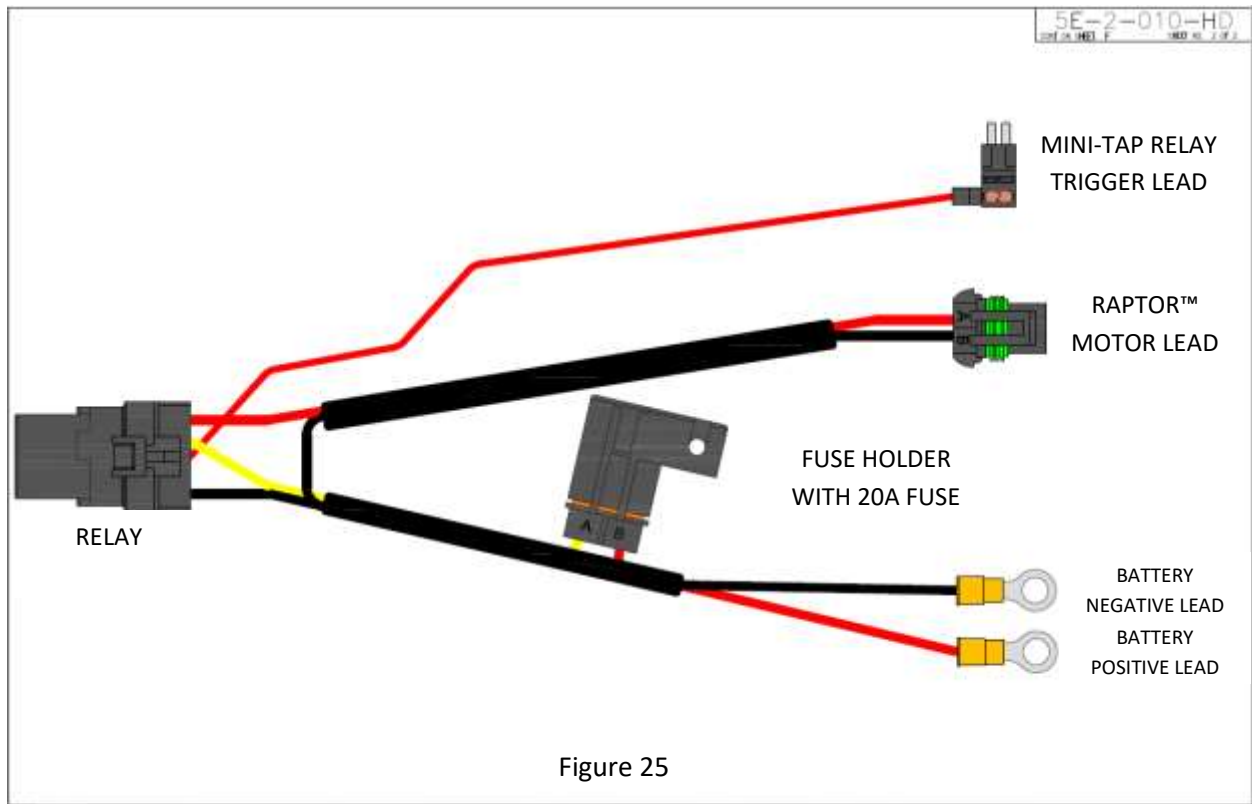

- 13-1. Secure the relay and fuse holder to the vehicle. Be sure to rout the wires away from any moving parts. The relay is illustrated below in figure 26. The fuse holder mounting is the same concept.



Figure 26

13-3. Remove the plastic cover on the fuse panel under the hood.



Figure 27

13-4. After accessing the fuse panel, locate a key on 12v hot source. This is the power source that will trigger the relay to power the Raptor-4G.

13-5. Remove the fuse from the selected slot and add it to the empty slot in the fuse tap. Your fuse tap should look like figure 28.



Figure 28

13-6. Plug the fuse tap into the open slot to where the fuse was removed. As mentioned before.



Figure 29

13-7. Next, hook up the power supply leads to either the battery or the alternator.

NOTICE

It is recommended that the power supply leads be connected to the alternator. Connecting the power supply leads to the alternator instead of the battery will create a corrosion free connection.

13-8. Route the red and black power supply leads to the alternator. Connect the black (-) lead to the alternator ground connection. Connect the Red (+) lead to the alternator hot lead going to the battery. Be sure to reinstall the protective cover.

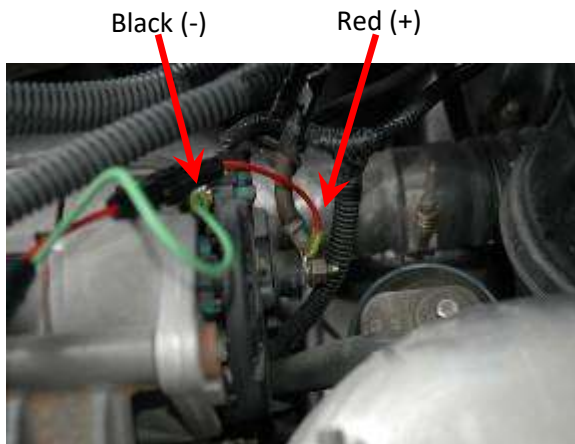

Figure 30



Figure 31

13-9. Should you choose to connect the power supply leads directly to the battery, connect the RED (+) lead to the POSITIVE (+) post of the driver's side battery. Connect the BLACK (-) lead to the NEGATIVE (-) post of the same battery.

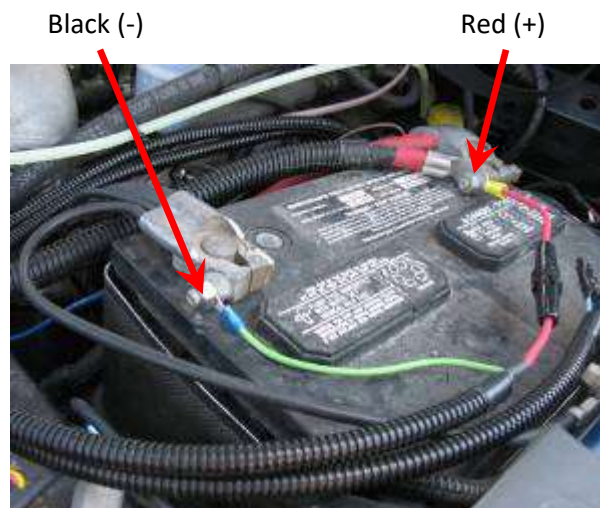

Figure 32

13-10. Run the Raptor-4G power supply lead down along the frame and plug it into the Raptor-4G until an audible click is heard.



Figure 33

13-11. Secure the wiring to the frame with the cable ties provided. Remember to keep the wiring away from any hot or moving parts such as exhaust or driveshafts.

INITIAL START PROCEDURE

- 14-1. The Raptor-4G is a self-priming system.
- 14-2. Before the truck is started it is recommended to check fuel pressure at the pump. To check fuel pressure before the truck is started, refer to section 15.
- 14-3. Turn the starter key to the on/run position.
- 14-4. Listen for a change of tone. A change of tone means the pump is primed and the engine is ready to start.
- 14-5. Start engine.
- 14-6. **RECHECK ALL FUEL FITTINGS FOR LEAKAGE AND PROPERLY TORQUE. BE SURE ALL FUEL LINES ARE PROPERLY ROUTED TO PROTECT FROM EXCESSIVE HEAT AND SECURED TO PROTECT FROM CHAFFING AND ABRASION. RECHECK ALL ELECTRICAL LINES, SECURE AS NECESSARY.**
- 14-7. Be sure to **fill out the supplied warranty card and mail it in within 30 days of purchase with a copy of either the receipt or packing slip** to be registered for the limited lifetime warranty. Failure to do so, and the pump will carry a 1 year warranty only. For a description of the warranty, refer to section 17.

PureFlow / AirDog
WARRANTY REGISTRATION CARD

MODEL NO. _____
SERIAL NO. _____
DATE OF PURCHASE: Month _____ Day _____ Year _____
QUANTITY OF THE AIRDOG: 1 2 3 4 5 6 7 8 9 10
COMMENTS:

NAME OF PURCHASER: _____
MAILING ADDRESS: _____
CITY: _____ STATE: _____ ZIP: _____
PHONE: _____ FAX: _____
E-MAIL ADDRESS: _____
I have read and have a copy of the Limited Lifetime Warranty covering this system.
Name: _____ Title: _____
This warranty is subject to the terms and conditions of the Limited Lifetime Warranty Registration Card and the product literature published by PureFlow / AirDog. It does not apply to any other PureFlow / AirDog products.
PUREFLOW / AIRDOG IS THE ONLY MANUFACTURER OF THIS PRODUCT AND WILL BE RESPONSIBLE FOR ALL REPAIRS TO THIS PRODUCT.
©2011 PureFlow / AirDog

Figure 34

ADJUSTING FUEL PRESSURE

- 15-1. Install a 1/8npt center back fuel pressure gauge in the pump or anywhere between the Raptor-4G and the injection pump. There are two 1/8npt ports on the raptor (Figure 35). The pressure port is the one on the right as pictured in figure 36. The left port will not read fuel pressure as it is the suction side of the pump. You will need a 3/16" allen to remove the pipe plug. AirDog® sells fuel pressure tees that will splice right into the Raptor-4G 1/2" fuel line. The part number for the Tee is 001-4A-1-0027-P and is pictured in figure 37.

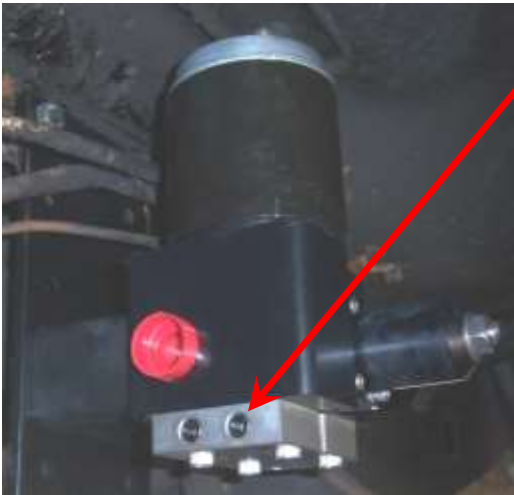

Figure 35



Figure 36



Figure 37

- 15-2. Once a fuel pressure gauge is installed, turn the key on so that the pump is running.
- 15-2. Loosen the jam nut with a 5/8 wrench and adjust the pressure using a 3/16" allen wrench. Clockwise for more pressure and Counter-Clockwise for less pressure. Once the correct pressure is achieved (8-10psi for this application) start the engine.
- 15-3. With the engine running, verify the pressure remains correct. Make any adjustments at this time, if needed. Once satisfied with the fuel pressure, tighten the jam nut back up to lock in the pressure.

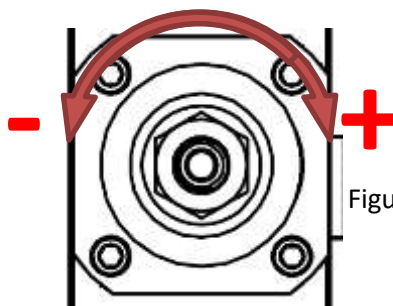

Figure 38

SERVICE AND TROUBLESHOOTING

In the unlikely event that there is an issue with pump performance, here are some steps to follow. If you have gone through these steps and you are still experiencing an issue, gather your serial number off of the silver plate on the pump and call into tech support at (877)-421-3187 and speak to a technician.

NOISY PUMP:

A noisy pump is most likely associated with a restriction or aeration in the suction side of the pump. Some troubleshooting steps are as follows:

1. Check the fuel line for any cracks or damage. Cracked or damaged fuel lines will pull in air and affect pump performance and cause the pump to run loudly. Replace any cracked or worn fuel lines.
2. Check for any leaking fittings. Leaking fittings may also cause a suction leak. Properly torque any leaking fittings.
3. Check for an inlet restriction. The Raptor-4G is equipped with an inlet screen to keep particles from jamming the pump. Remove the inlet fitting and inlet screen adapter to check for debris. Blow out debris and reinstall inlet screen adaptor and inlet fitting. **DO NOT RUN THE PUMP WITHOUT THE INLET SCREEN!**
4. If the previous steps fail to quiet down the pump, perform a bucket test to eliminate issues at the tank. To perform a bucket test, remove the suction line from the fuel tank, put it in a bucket of fuel, and run the pump. If the noise goes away, the issue is within the fuel tank or at the fuel tank connection. If the noise does not go away, get your serial number off the pump and call tech support at (877) 421-3187.

EXCESSIVE FUEL PRESSURE DROP UNDER ACCELERATION:

A pressure drop of a couple psi is to be expected. Excessive fuel pressure drops under acceleration can be associated with an inlet restriction and/or suction leaks as well. Run through steps 1-3 in the "NOISY PUMP" section. If pump pressure still drops excessively, get the serial number off the pump and call into tech support at (877) 421-3187.

PUMP LEAKS FUEL:

The Raptor-4G is equipped with O-ring boss style fittings that use an O-ring to seal the fittings to the pump. Here are some steps to follow in case the pump leaks fuel:

1. Verify the fittings are properly torqued per section 6 in this manual. If fittings are loose, properly torque them.
2. Clamp off the fuel lines to prevent fuel loss and remove the “tombstone” cap from the bottom of the pump by removing the four 3/16 allen head cap screws. Inspect the O-rings for any damage. Replace any damaged O-rings with ones from the O-ring service kit that came with this pump. Be sure the O-rings are completely seated in the grooves, or damage to the O-rings may occur when re-installing the cap.
3. If fuel appears to be leaking between the mounting plate and the pump or the previous steps did not cure the issue, get the serial number off the pump and call the tech department at (877) 421-3187.

PUMP DOES NOT RUN:

A no pumping situation can be associated with either an electrical or mechanical issue. Here are some steps to run through to identify the issue:

1. Inspect the inline fuse. If the fuse is blown, replace the fuse. If the fuse blows immediately, go to the next step. If the fuse is not blown, go to step 6.
2. A fuse that blows immediately indicates a possible jam in the Gerotor. To inspect the Gerotor, remove the four 3/16” allen head cap screws from the bottom of the pump and remove the “tombstone” cap and remove the gears. The gears may fall out, so be take care when removing. If the gears do not fall out, use a magnet to remove the gears.
3. With the gears out, replace the fuse and key on the truck to turn on the pump. If the pump still blows the fuse, call into tech support with your serial number (877) 421-3187. If the fuse does not blow, continue to the next step.
4. Spin the removed gears in your hand to verify free movement. If the inner gear does not move within the outer gear, separate the two and clean out any debris present. Once the gears are clear of debris, lubricate them with clean motor oil, reinstall them, be sure the O-rings from the cap are in the correct place in the grooves, and reinstall the cap using the previously removed cap screws.
5. After re-installing the gears and the fuse still blows, get your serial number and call tech support (877) 421-3187.

6. Verify there is 12 volts reaching the pump by disconnecting the Deutsch 2 pin connector at the pump and measure voltage across the pins on the harness side. You must key on get the pump to turn on. If there is power at the pins and the pump does not run, grab the serial number off the pump and call into tech support at (877)421-3187. If there is no power at the connector, go to the next step.
7. Remove the relay from the harness and jump pins 87 and 30 with a section of wire on the harness side. Turn the key on. If the pump comes on, replace the relay. If the pump still does not run, grab the serial number and call into tech support at (877) 421-3187.
8. If there is no power at the pump on the harness side and jumping the relay and the fuse is not blown, there is break in wiring harness somewhere

NO SUCTION:

1. Verify the pump is running. If the pump is not running, refer to the “Pump Does Not Run” section.
2. If the pump runs, clamp off the suction line to keep fuel spillage minimal and disconnect it from the pump. With the pump running, feel for suction at the pump fitting. If suction is felt, there is an issue with the suction line or tank pulling in air and continue on to step 3. If weak or no suction is felt at the pump, inspect the inlet screen for debris. Excessive debris in the screen will cause low suction. Clean the inlet screen by removing the inlet screen adapter and blowing it out. Reinstall and check for better suction. If suction is better, reinstall the fuel line. If suction is not better, continue to step 4.
3. Inspect the fuel line for any cracks and replace if necessary. If the suction line looks fine, perform a bucket test as described in step 4 of the “Noisy Pump” section. If the pump picks up fuel at that point, the issue is internal to the fuel tank suction tube.
4. If suction is still weak, get the serial number off of the pump and call into tech support at (877) 421-3187.

NO PRESSURE:

1. Verify the pump has suction by running through the “No suction section.”
2. If the pump has suction, verify the fuel pressure by installing a fuel pressure gauge as described in section 13.
3. If the pump pressure is too low, adjust the fuel pressure as described in section 13 to 8-10psi.
4. If the pump performance does not improve and the previous checks have been verified, get the serial number off of the pump and call into tech support at (877) 421-3187.

PUREFLOW AIRDOG LIFETIME LIMITED EXPRESS WARRANTY**IMPORTANT NOTICE**

TO ACTIVATE YOUR PUREFLOW AIRDOG WARRANTY, YOU MUST COMPLETE AND MAIL YOUR WARRANTY CARD TO PUREFLOW AIRDOG WITH A COPY OF YOUR ORIGINAL SALES RECEIPT WITHIN 30 DAYS OF PURCHASE. FAILURE TO COMPLETE AND SUBMIT YOUR WARRANTY CARD WILL RESULT IN A WARRANTY PERIOD OF THE COVERED PRODUCE TO ONE (1) YEAR FROM THE DATE OF PURCHASE.

PureFlow AirDog (hereafter collectively, "SELLER") warrants and guarantees only to the Original Purchaser (hereafter collectively, BUYER) that All PureFlow AirDog Systems (hereafter collectively, PRODUCT) shall be free from defects of materials and workmanship in the manufacturing process for as long as the BUYER owns the PRODUCT.

The Lifetime Limited Express Warranty is limited to the PRODUCT purchased by the original BUYER of the PRODUCT and limited solely to the parts contained within the PRODUCT and EXCLUDES ALL ELSE INCLUDING FILTERS AND WATER SEPARATORS. Any PRODUCT that is in question of Warranty must be returned, shipped prepaid, to PureFlow AirDog. All Warranty claims are subject to the approval of PureFlow AirDog. If it is determined that a Warranty claim exists, PureFlow AirDog will, at its sole discretion, replace the defective PRODUCT with a comparable PRODUCT, repair the defective PRODUCT, or refund the BUYER'S purchase price in exchange for the PRODUCT. Repairs or replacements are warranted for only the remainder of the original warranty period and only to the original BUYER.

Under no circumstances shall the SELLER be liable for any labor charged or travel time incurred in the diagnosis for defects, removal, or reinstallation of the PRODUCT, or any contingent expense.

Under no circumstances will the SELLER be liable for any damage or expense incurred by reason of the use or sale of the PRODUCT.

Other than expressly set forth herein, the SELLER shall in no way be responsible for the proper or improper use and service of the PRODUCT. In no event shall the SELLER be liable for any special, incidental, indirect or consequential damages of any kind or nature, whether or not the BUYER of the PRODUCT was advised of the possibility of damage or harm, arising or resulting from the use or performance of the PRODUCT and BUYER hereby waives the right to any and all such claims.

BUYER, acknowledges that he/she is not relying on SELLER'S skill or judgment to select or furnish goods suitable for any particular purpose and that SELLER has no liability that will extend beyond the scope of the LIMITED EXPRESS WARRANTY contained herein, and BUYER hereby waives all remedies or liabilities, expressed or implied, arising by operation of law or otherwise.(including, without limitation, any obligation of SELLER with respect to fitness for any particular purpose; merchantability; and special, incidental, indirect or consequential damages) or whether or not occasioned by SELLER'S negligence.

SELLER disclaims any warranty and expressly disclaims any liability for personal injury or damages related to BUYER'S use of the PRODUCT. BUYER acknowledges and agrees that the disclaimer of any liability for personal injury is a material term for this agreement and BUYER agrees to indemnify SELLER and hold SELLER harmless from any claim related to the PRODUCT and its use or performance. Under no circumstances will SELLER be liable for any damages, liabilities, costs or expenses incurred as a result of or by reason of use, performance or sale of the PRODUCT, including without limitation, any damages, liabilities, costs or expenses incurred by reason of BUYER'S negligence related to those uses of the PRODUCT.

The proper installation of the PRODUCT is the sole responsibility of the BUYER. The SELLER assumes no liability regarding improper installation or misapplication of the PRODUCT.

Section 17 (Continued)

WARRANTY

SELLER hereby provides the following limited warranty as to description, quality, merchantability, fitness for the PRODUCT'S purpose, productiveness, or any other matter of SELLER'S PRODUCT sold herewith. The SELLER

shall be in no way responsible for the open use and service of the PRODUCT and the BUYER hereby waives all rights other than those expressly written herein. This Warranty shall not be extended or varied except by a written instrument signed by SELLER and BUYER.

IN THE EVENT THAT THE BUYER DOES NOT AGREE WITH THIS AGREEMENT, THE BUYER MAY PROMPTLY RETURN THE PRODUCT, IN A NEW AND UNUSED CONDITION, WITH A DATED PROOF OF PURCHASE, TO THE PLACE OF PURCHASE WITHIN THIRTY (30) DAYS FROM THE DATE OF PURCHASE FOR A FULL REFUND. THE BUYER AGREES THAT THE INSTALLATION OF THIS PRODUCT CONFIRMS THE BUYER HAS READ AND UNDERSTANDS THIS AGREEMENT AND ACCEPTS THE TERMS AND CONDITIONS OF THIS AGREEMENT.

Warranty Procedure

In the unlikely event a warranty appears as if it may be warranted, the following steps are taken:

- 1 The customer discussed the symptoms of the problem with a PureFlow AirDog Technician. The customer is to have the system Serial Number and Model Number available for the Technician when the call is made. This will expedite all steps of the process.
- 2 The customer performs any and all tests requested by the PureFlow AirDog Technician. This is done to isolate the potential problem while eliminating potential installation or maintenance related issues,
- 3 If the PureFlow AirDog Technician determines based on the customer feedback concerning the requested testing that system may be at fault, the customer is advised that all returned pumps are tested upon arrival and should this returned pump perform at design criteria upon arrival, the customer will be charged a \$50.00 fee.
- 4 The PureFlow AirDog Technician will first request the customer's phone number in the event the phone call is accidentally disconnected and then transfer the customer to a PureFlow AirDog Customer Service Representative. Should a Customer Service Representative not be available, the Technician will offer the Customer the option to hold, call back, or receive a return call.
- 5 The PureFlow AirDog Customer Service Representative will check to determine if the customer's Warranty Registration Card is on file.
 - a. If no Warranty Registration is found, the customer will be required to supply the original purchase receipt showing the purchase date.
 - b. If no Warranty Registration is found, the customer will be advised of the options should the system in question is out of the default warranty period (1 year).
- 6 The PureFlow AirDog Customer Service Representative will request the customer information, including: Name, Address, Phone Number, Model Number, Serial Number, Year / Make / Model of vehicle, Name of Dealer purchased from, Purchase Date, Description of Problem, Customers' understanding of the resolution, and customer credit card information.
- 7 PureFlow AirDog will cover Ground Shipping charges to ship the replacement unit and will include a prepaid shipping label for the return of the defective unit. Any additional items ordered at the time of the replacement shipment will include their portion of the shipping cost.
- 8 A period of 15 Calendar Days from the time of shipment is provided for the receipt of the defective unit at the PureFlow AirDog facility. Failure to return ship the defective unit to arrive within the defined time period will result in a charge of \$250.00 against the customer's credit card as the purchase cost of the defective unit.

REVISED November 3, 2025