

#29

AirDog[®] **DF-100-5G** **FUEL PREPARATOR**[®] **DF-165-5G**

PATENT PROTECTED:

<https://pureflowairdog.com/p-35853-patents.html>

2001-2010 DURAMAX INSTALLATION INSTRUCTIONS

**PLEASE READ AND CHECK CONTENTS
BEFORE INSTALLATION**



**PUREFLOW AIRDOG
705 W MAUSOLEUM RD.
SHELBYVILLE, IN 46176**

**877-421-3187
PUREFLOWAIRDOG.COM**

TABLE OF CONTENTS

SECTION	DESCRIPTION	PAGE
1	TABLE OF CONTENTS	2
2	INTRODUCTION	3
3	SAFETY GUIDELINS	4
4	PRE-INSTALLATION CHECKS	5
5	PARTS LIST	6
6	BOLT KIT PARTS LIST	7
7	INSTALLATION ILLUSTRATION	8
8	AIRDOG® PUMP FITTING INSTALLATION	9
9	INSTALLING THE AIRDOG® ON THE BRACKET SYSTEM	11
10	INSTALLING THE AIRDOG® ON THE TRUCK FRAME	13
11	FUEL LINE ASSEMBLY OVERVIEW	14
12	FUEL SUPPLY LINE (FROM THE AIRDOG® TO THE INJECTION PUMP)	15
13	SUCTION LINE (FROM THE TANK TO THE AIRDOG®)	17
14	RETURN LINE (FROM THE AIRDOG® TO THE FUEL TANK)	18
15	WIRING HARNESS	20
16	INITIAL START PROCEDURE	23
17	FUEL FILTER MAINTENANCE	24
18	CLEANING THE GEROTOR ASSEMBLY	25
19	PRESSURE REGULATOR ADJUSTMENT	26
20	WARRANTY	27

Thank you for choosing AirDog® for your truck fueling needs!

AirDog® recommends that a certified diesel shop technician install this product. Please note, if the end user performs the installation, it is recommended they have basic knowledge on how electric fuel systems operate and function. Failure to properly set up this fuel system may result in a voided warranty. **If properly set up per these instructions, the pump head carries a lifetime warranty to the original purchaser.** THIS WARRANTY IS NON-TRANSFERRABLE!

The AirDog® II-5G uses an adjustable diaphragm fuel pressure regulator to regulate the fuel pressure to the injection system. The pressure for this application is preset from the factory at 8-10psi. If a different pressure is desired, go to page 26 for instructions on how to adjust the pressure. **WARNING: RUNNING THE PUMP ABOVE 75PSI FOR THE DF-100 AND DF-165 WILL DECREASE THE LIFE OF THE PUMP SIGNIFICANTLY AND MAY VOID THE WARRANTY. MORE FUEL PRESSURE DOES NOT MEAN MORE FUEL FLOW AND TOO MUCH PRESSURE MAY DAMAGE YOUR INJECTION SYSTEM! MORE FUEL PRESSURE DOES NOT MEAN MORE FUEL FLOW!**

OVERVIEW ON HOW THE SYSTEM OPERATES

The AirDog® draws fuel from the tank from a high flow suction tube installed in the tank. The fuel is then pulled through a water separator before being pressurized through the Gerotor pump. The pressurized fuel is sent through the 2 micron fuel filter before being sent to the engine. The pump maintains pressure through a diaphragm fuel pressure regulator that recirculates fuel back through the water separator. The excess fuel is sent back to the tank through a supplied fuel filler neck return tee.

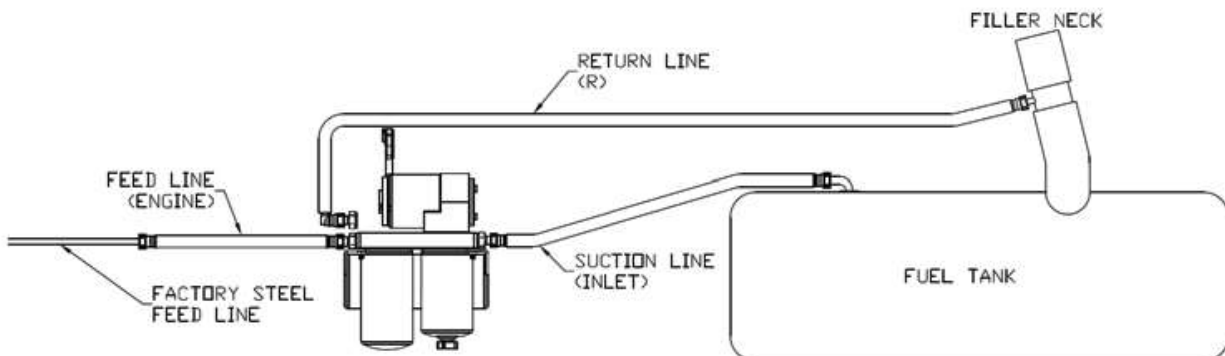



SAFETY INSTRUCTIONS

LEARN TO RECOGNIZE SAFETY INFORMATION

This is the safety alert symbol. When you see this symbol in this manual, **BE ALERT TO THE POTENTIAL FOR PERSONAL INJURY!**

Follow recommended precautions and safe operating practices.



UNDERSTANDING SIGNAL WORDS

A signal word-**DANGER**, **WARNING**, or **CAUTION** is used with the safety alert symbol.

DANGER indicates a hazardous situation which, if not avoided, **WILL** result in death or serious injury.



WARNING indicates a hazardous situation which if not avoided, **COULD** result in death or serious injury.



CAUTION indicates a hazardous situation which if not avoided, **COULD** result in minor or moderate injury



NOTICE indicates a preferred installation procedure.





The installation of your AirDog® can be made relatively easy by following the steps outlined in this manual, and:

1. Inventory the package components completely. Notify PUREFLOW AIRDOG® immediately of any missing or damaged parts! 317-421-3180
2. Read the installation manual completely. Understand how the system operates and understand the installation recommendations before beginning the installation.
3. The installation recommendations contained herein are suggested installation guidelines only. Individual installations may vary.
4. If any installation procedure is uncertain, contact PUREFLOW® AIRDOG for technical assistance.
5. When installing the AirDog® fuel lines be sure to keep the **ORIGINAL ENGINE RETURN LINE** connected as it is from the factory!

SAFETY GUIDELINES!



Please be sure to chock the vehicle's tires to prevent rolling



Please use proper supports when working beneath an elevated vehicle



Most diesel pickups have two (2) 12 volt batteries. Disconnect the battery cables to both batteries before proceeding with the AirDog® installation



Vehicle main framrails should not be drilled into or welded upon.



Wear safety glasses or shield when using tools such as drills and grinders or when using a punch or chisel



Prolonged exposure to loud noise can cause impairment or loss of hearing. Wear suitable hearing protective devices such as ear muffs or ear plugs to protect against loud noises.



Use common sense when routing fuel lines and electrical wiring. Keep them away from hot exhaust components and/or moving parts. Properly secure lines to prevent chaffing.

AirDog® Parts List

QTY	DESCRIPTION	PART NUMBER	IMAGE
1	AirDog®II-5G	DF-100-5G Or DF-165-5G	
1	AirDog® Mounting Bracket	001-3C-0004	
1	Mounting Bracket Hardware Kit	901-61-0102-PM-C	
1	Frame Bracket Front	010-3C-0001	
1	Frame Bracket Back	010-3C-0002	
1	Spacer	010-3C-0003-A-P	
1	Wiring Harness	5E-2-010-HD	
1	Return Fuel Filler Tube (with 2 Clamps)	001-4A-1-0200	
1	Bundle of Plastic Ties	5H-2-1-B	
1	20ft of Hose	HS20	
5	1/2" Straight Hose Quick Connect End	FQC12S	
1	3/8" 90° Hose Quick Connect End	FQC3890	
2	1/2" Male J2004 Quick Connect x 3/4" UNF	08J2044-3/4UNF	
1	3/8" Male J2004 Quick Connect x 7/16" UNF	06J2044716UNF	
1	Customer Service O-ring Replacement Kit	901-05-0500	

901-61-0102-PM-C Bolt Kit Parts List









QTY	DESCRIPTION	IMAGE
4	1/4-20 X 1.25" SOCKET HEAD CAP SCREW	
4	1/4-20 NUT	
4	1/4" SPLIT-LOCK WASHER	
3	3/8-16 X 4" HEX HEAD CAP SCREW	
3	3/8-16 NUT	
3	3/8" SPLIT-LOCK WASHER	
4	5/16-18 X 3" FLAT SOCKET HEAD CAP SCREW	
4	5/16-18 NUT	
4	5/16" SPLIT-LOCK WASHER	

ILLUSTRATION OF QUICK CONNECT COMPONENTS

IMAGE IS NOT TO SCALE

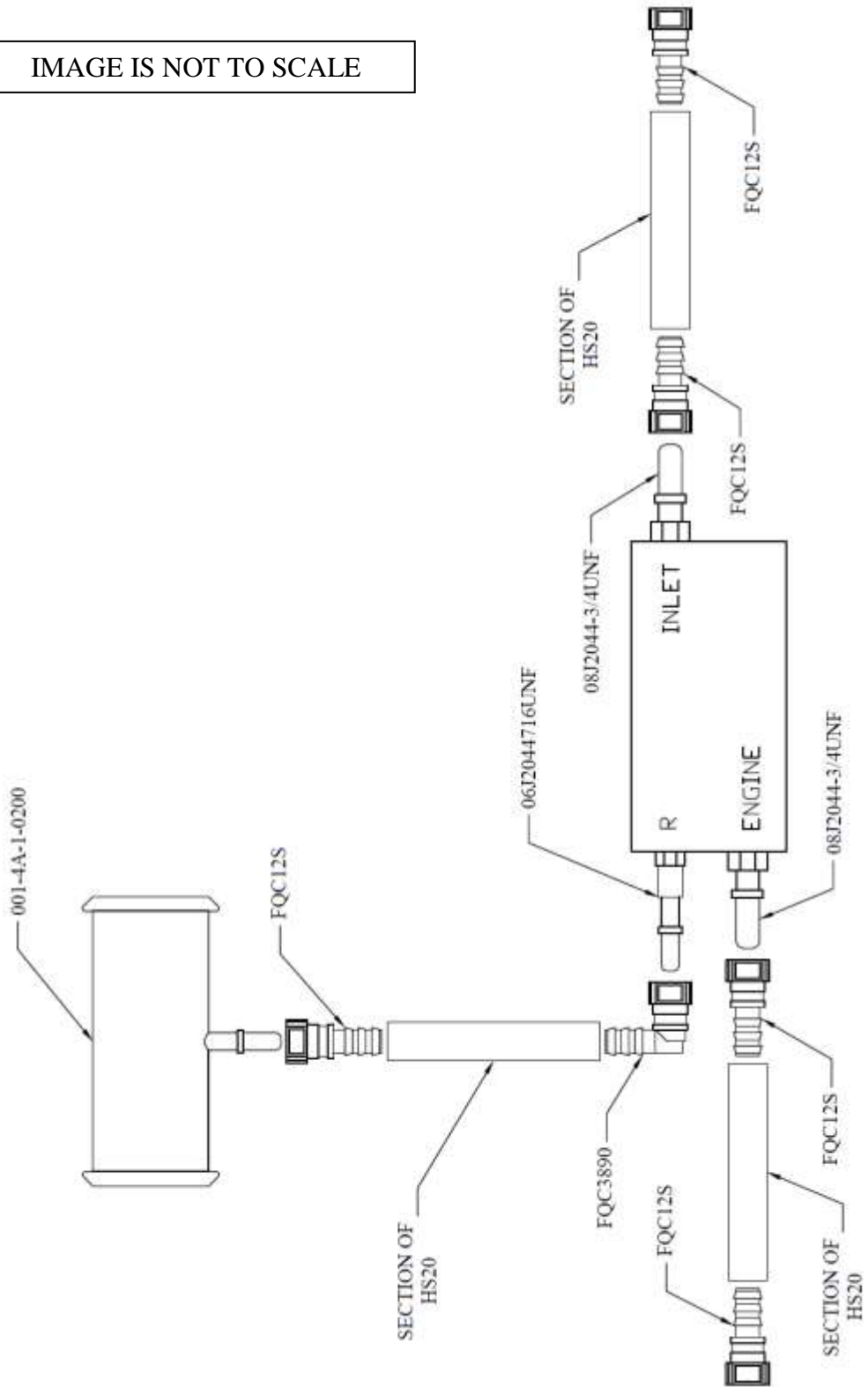

Installing the j2044 Quick Connect Fittings into the AirDog® II-5G Filter Base

TOOLS NEEDED:

- Torque Wrench
- 7/8" Deep Socket
- 9/16" Deep Socket

PARTS NEEDED:

- 2x 08J2044-3/4UNF Fittings
- 06J2044716UNF Fitting

- 8-1. Dip the threaded end of the 08J2044-3/4UNF fitting into clean motor oil and hand-thread into the "ENGINE" and "INLET" ports of the AirDog® II-5G filter base as illustrated in figures 1, 2, and 3. Using a 7/8" deep socket, torque the fittings to 180in-lb or 15ft-lb.
- 8-2. Dip the threaded end of the 06J2044716UNF fitting into clean motor oil and hand-thread into the "RETURN" port of the the AirDog® II-5G filter base as illustrated in figures 1 and 2. Using a 9/16" deep socket, torque the fitting to 84in-lb or 7ft-lb.

NOTICE

DO NOT overtighten the fittings or damage may occur!

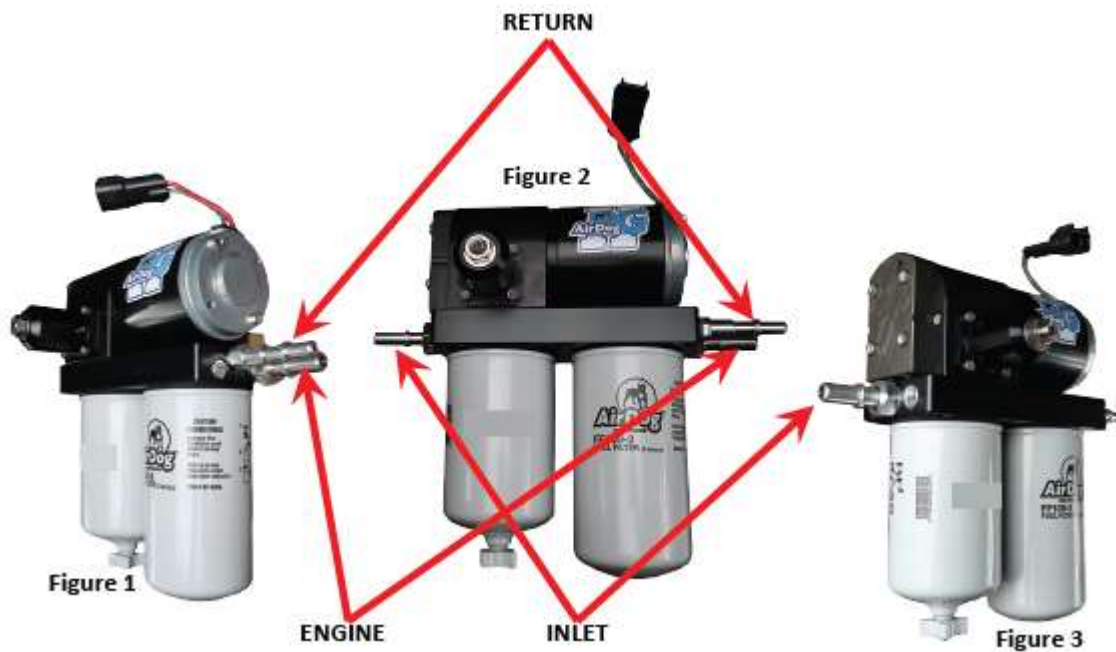

Section 9

Installing the Pump on the Bracket System

TOOLS NEEDED:

- 3/16 Allen
- 7/16 Socket or Wrench

PARTS NEEDED:

- 4x 1/4-20 x 1.25 Socket Head Cap Screws
- 4x 1/4" Lock Washers
- 4x 1/4-20 Nuts
- 001-3C-0004 Cradle Bracket

INSTALL THE AirDog® ON THE CRADLE BRACKET

- 9-1. First, take a look under the truck and pick a location where the pump and brackets will fit. Once the location is known, orient the pump in the cradle bracket with the suction line "INLET" pointed towards the fuel tank.

NOTICE

We do recommend mounting the system on the inside of the frame if possible.

- 9-2. Using the above listed hardware, mount the AirDog® to the cradle bracket (001-3C-0004) in the desired orientation (inlet fitting facing the rear of the vehicle) using a 7/16 socket and 3/16 allen wrench.



Figure 4



Figure 5

TOOLS NEEDED:

- 3/16 Allen
- 1/2 Socket or Wrench

PARTS NEEDED:

- 4x 5/16-18 x 3.0" Flat Socket Head Cap Screws
- 4x 5/16" Lock Washers
- 4x 5/16-18 Nuts
- 010-3C-0001 Front Frame Sandwich Plate (Multiple Holes)
- 010-3C-0003-A-P Spacer Block

INSTALL THE AirDog® ON THE BRACKET SYSTEM

- 9-3. Mock the Front Frame Sandwich Plate (Multiple Holes) (010-3C-0001) on the frame and hold the pump assembly up to it. Be sure to choose a set of holes that tucks the pump up as far as possible without touching the bottom of the cab and use those holes to mount the pump in the next step.

NOTICE

Make sure the pump wires do not contact the bottom of the cab! Pump Failure due to rubbed through/shorted wiring from improper installation is not covered under warranty!



Figure 6

**BRACKET
TOP**



**BRACKET
BOTTOM**

- 9-4. Assemble the AirDog mounting bracket (001-3C-0004) to the frame bracket (010-3C-0001) using the spacer (010-3C-0003-A-P) as shown in figure 7 using the four bolts, lock washers, and nuts included in the mounting bracket hardware kit (figure 8). Properly torque all fasteners! The bracket assembly should look like figure 9. You will need a 3/16" Allen and a 1/2" Wrench. The finished assembly should look like figure 10.



Figure 7



Figure 8



Figure 9



Figure 10

Section 10

Mounting the Pump to the Truck Frame

Tools Needed:

- 2x 9/16" wrenches or socket wrenches

Parts Needed:

- 3x 3/8-16 x 4" Hex Head Cap Screw
- 3x 3/8 Lock Washers
- 3x 3/8-16 Nuts
- 010-3C-0002 Back Frame Sandwich Plate

INSTALL THE AirDog® ON THE TRUCK FRAMERAIL

- 10-1. Clamp the frame between the AirDog® bracket assembly and the back frame sandwich plate (010-3C-0002) using the 3/8" x 4" bolts, lock washers, and nuts included in the kit. Use two 9/16" wrenches to tighten. The two bolts go on top (Figure 11) and the single bolt goes on the bottom (Figure 12).

NOTICE

DO NOT overtighten the bolts or you may bend the brackets and chip the powdercoat! Only tighten until the lock washers are flat.

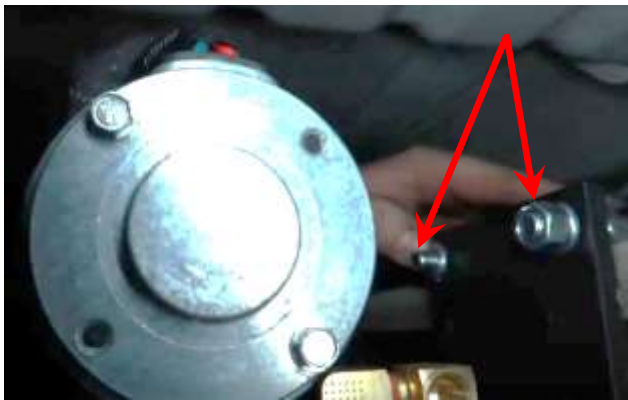

Figure 11



Figure 12



Figure 13



Figure 14

Fuel Line Assembly Overview

This kit includes a length of fuel line and separate fuel line ends to allow for much cleaner looking installations! Assemble the fuel lines as you install them per the instructions later in this manual. This section is for explanation purposes.

NOTICE

Do not pre-assemble the fuel lines or the lengths will not be correct!

- 11-1. Take the fuel line end and lubricate the barbed end with clean motor oil (Figure 15) and press it into the fuel line (HS20) until all of the barbs are covered (Figures 16 and 17). The fuel line end should look like Figure 17.



Figure 15



Figure 16



Figure 17

- 11-2. Now plug that fuel line with that fitting into the connection on the either the AirDog® or the truck where the manual calls it out.
- 11-3. Run the fuel line along the frame away from any hot or moving parts such as exhaust or the driveshaft (Figure 18). Cut the hose to length and insert the other fuel line end that the manual calls out into the fuel line as outlined in step 11-1.



Figure 18

NOTICE

Hose clamps are not needed for these push-lock connections! They may cause damage to the hose and cause leaks. Damage due to hose clamps is not covered under warranty!

TOOLS NEEDED:

- 1/2" Fuel Line Disconnect Tool
- Clean Motor Oil or ATF
- Hose Cutters or a way to cut Fuel Line

PARTS NEEDED:

- 2x FQC12S
- HS20 20ft Fuel Line

Installing the AirDog® Fuel Supply Line to the Engine

To install the AirDog® fuel supply line to the engine, you must first remove the (flexible) factory fuel line connecting the fuel tank to the frame mounted steel fuel line (Figure 22). It will be the larger of the two lines that are on the frame.

NOTICE

The fuel tank connections are located behind the tank shield. It may be necessary to remove or bend the tank shield down to access the suction tube quick connect fitting.

- 12-1. Remove the factory fuel supply line from the fuel tank suction tube. Place the 1/2" fuel line disconnect tool around the fuel line and press into the Quick Connect fitting to release the locks. Carefully pull the factory quick connect fitting and fuel line from the fuel tank suction fitting.



Figure 19

The DISCONNECT TOOL (as seen below) can be purchased from your local auto parts store. **This tool is NOT included in the kit.**



Figure 20

Section 12 (Continued)

Fuel Supply Line (From the AirDog® to the Injection Pump)

- 12-5. Disconnect the other end of the fuel supply line from the steel line using the disconnect tool. It is the larger of the two lines on the frame. This connection is located between the frame bracket and the front of the fuel tank. You may now remove the 18" of factory flex line.

Figure 21

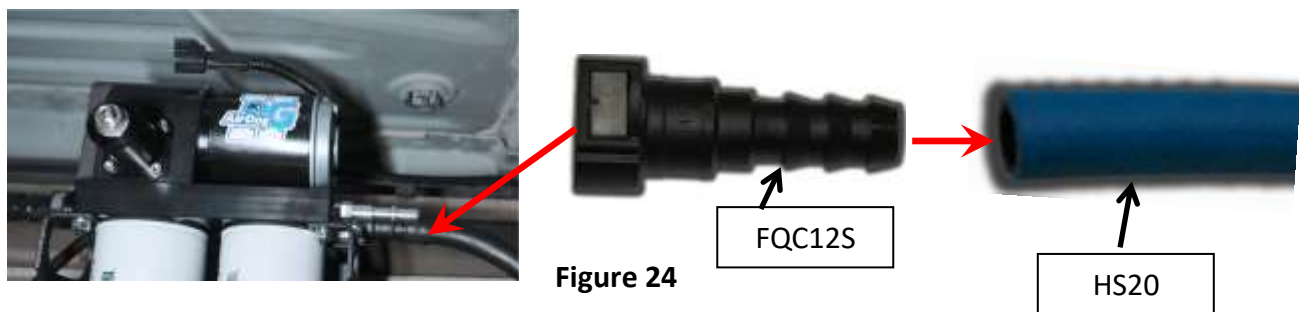

Figure 22

- 12-6. Assemble one end of the hose (Reference section 11) using fuel line end FCQ12S and plug it into the J2044 male connection on the factory fuel line to where the factory suction line was just removed from behind the fuel cooler in the previous step. A "click" will be heard once properly connected.



- 12-7. Run the fuel line along the frame as mentioned in step 11-3 to the "Engine" port in the AirDog®. Cut the fuel line to length and insert fuel line end FCQ12S per step 11-1. Once the connector is installed, connect it to the male J2044 fitting in the "Engine" port in the AirDog®. A "click" will be heard once properly connected.



NOTICE

Properly secure all fuel lines to prevent damage from chaffing and/or abrasion.

TOOLS NEEDED:

- Clean Motor Oil or ATF
- Hose Cutters or a way to cut Fuel Line

PARTS NEEDED:

- 2x FQC12S 1/2" Straight Quick Connect Fitting
- HS20 20ft Fuel Line

Fuel Suction Line for AirDog® II-5G

13-1. Assemble one end of the hose (Reference section 11) using fuel line end FCQ12S and plug it into the J2044 male connection in the AirDog® labeled "INLET." A "click" will be heard once properly connected.



13-2. Assemble one end of the hose (Reference section 11) using fuel line end FCQ12S and plug it into the male connection to where the factory suction line was just removed in step 12-1. A "click" will be heard once properly connected.

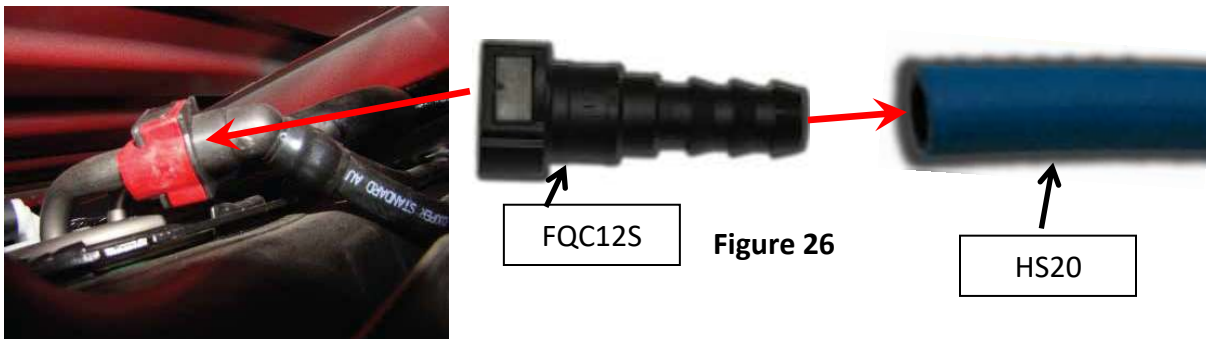

TOOLS NEEDED:

- Clean Motor Oil or ATF
- Hose Cutters or a way to cut Fuel Line and the Filler Neck

PARTS NEEDED:

- 001-4A-1-0200 2" Filler Neck Return Tee with Clamps
- FQC3890 3/8" 90deg Quick Connect Fitting
- FQC12S 1/2" Straight Quick Connect Fitting
- HS20 20ft Fuel Line

AirDog® Fuel Return Line

Installing the fuel 'Return to Tank' assembly in Filler Tube

- 14-1. Cut filler tube as illustrated in figure 27, removing 1/2 inch of hose. Loose assemble clamps on each end of filler tube before the filler tube is pushed in.
- 14-2. Insert the "Return Fuel Filler Tube" assembly (P/N 001-4A-1-0200) in the filler tube. **INSTALL THE FILLER TUBE WITH ARROWS, WHICH ARE STAMPED IN THE PART, POINTING TOWARD THE TANK!! SEE FIG 28.** Properly tighten clamps.

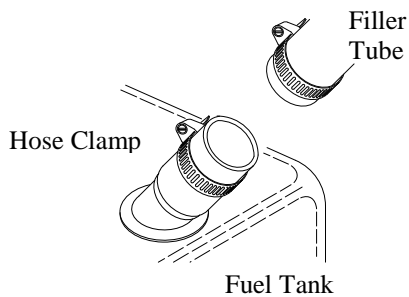

Figure 27



Figure 28



Figure 29

- 14-3. Assemble one end of the hose (Reference section 11) using Fuel line end FQC3890 and plug it into the "Return" J2044 fitting installed in the AirDog® (Figure 30). A "click" will be heard once the fitting is properly connected.

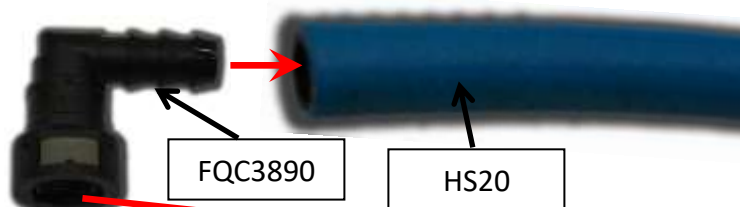

Figure 30



- 14-4. Run the fuel line along the frame as mentioned in step 11-3 to the filler neck tee. Cut the fuel line to length and insert fuel line end FQC12S per step 11-1. Once the connector is installed, connect it to the male J2044 fitting in the filler neck tee (001-4A-1-0200). A “click” will be heard once properly connected.

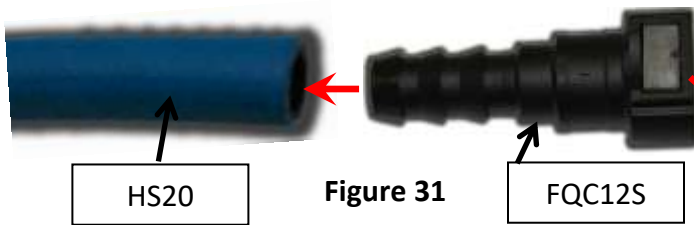

Figure 32

AirDog® Wiring Harness Install WIRING DIAGRAM

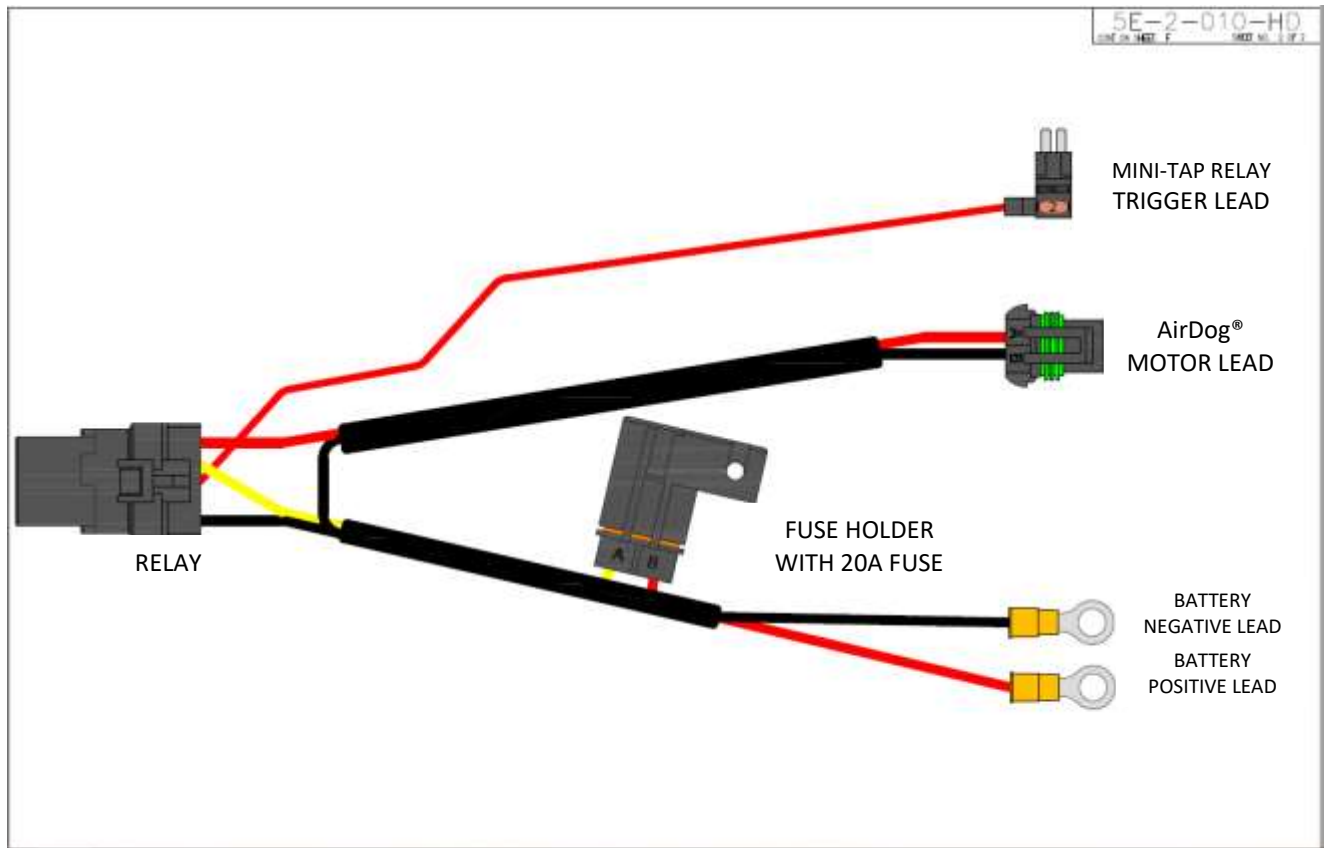

Figure 33 (Not to Scale)

Secure the Relay and Fuse Holder to the Vehicle

- 15-1. Secure the relay and fuse holder to the vehicle. Be sure to rout the wires away from any moving parts. The relay is illustrated below in figure 34. The fuse holder mounting is the same concept.



Figure 34

Connecting the AirDog® Relay Control

- 15-2. Remove the plastic housing (skirt) around the fuse box. On some models it may be necessary to remove the fender/cowl brace to allow access to the fuse box
- 15-3. After accessing the fuse panel, use a test light or voltmeter to find a fuse terminal that is **HOT** only when the ignition is in the on position. Connect the 'Red' Relay Trigger wire with the mini fuse tap to that terminal. Be sure to install the fuse that is removed back into the fuse tap we supply, once installed into the fuse box the fuse tap should have both fuse spots filled. **TBC Batt, Ign 1 or 2, Acc and HVAC are commonly used to supply power.**



Figure 35

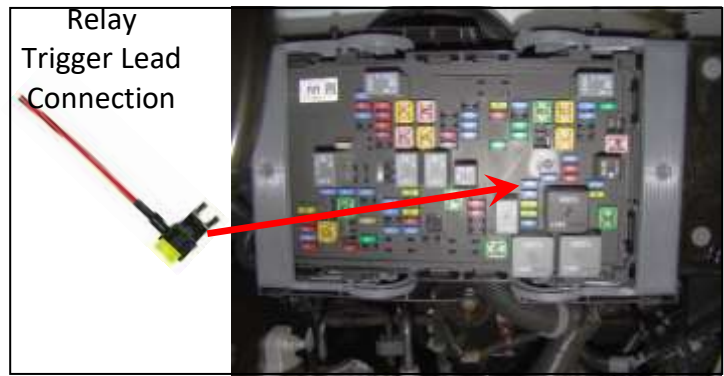

Figure 36

Connecting the Power Supply Leads to the Alternator or Battery

NOTICE

Connecting the power supply leads to the alternator instead of the battery will create a corrosion resistant connection.

- 15-3A. Route the Red and Black power supply leads to the alternator. Connect the Black (-) lead to the alternator Chassis Ground connection. Connect the Red (+) lead to the alternator Hot Lead going to the battery.

Black (-)

Red (+)

Replace the Protective Cover



Figure 37



Figure 38

Connecting the power supply leads Continued

- 15-4B. Should you choose to connect the power supply leads directly to the battery, connect the Red (+) led to the Positive (+) post of the driver's side battery. Connect the Black (-) lead to the Negative (-) post of the same battery.

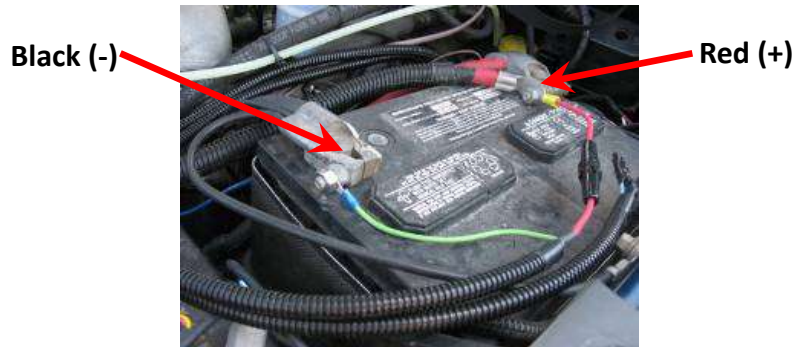

Figure 39

- 15-5. Route the wiring harness to the AirDog® and connect the 2 pin Deutsch connector to the corresponding connector on the AirDog®.

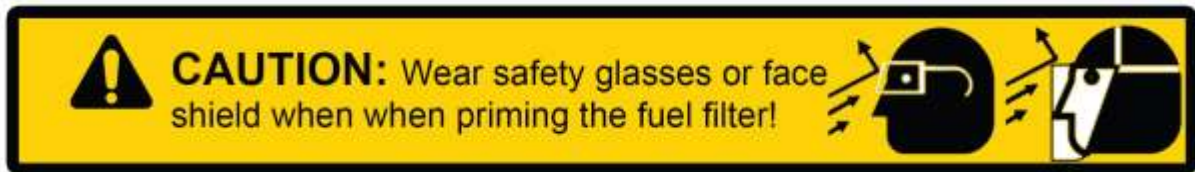

Figure 40

INITIAL START PROCEDURE

The AirDog® is a self-priming system, however, to prevent potential damage to the system, it is recommended to fill the pre-filter with diesel fuel before initial startup.

- 16-1. Fill the water separator with diesel fuel.
- 16-2. Turn the starter key to the on/run position.
- 16-3. While the AirDog® is operating, bleed the air from the fuel line to the engine by loosening the fuel line connection at the engine fitting. As soon as the line is purged of air and pure fuel is observed, properly tighten the fuel fitting.



NOTE: put a rag or shop towel over and around fitting to prevent splatter. Catch all spilled fuel and dispose of properly.

- 16-4. Start the engine!

RECHECK ALL FUEL FITTINGS FOR LEAKAGE AND PROPERLY TORQUE. BE SURE ALL FUEL LINES ARE PROPERLY ROUTED TO PROTECT FROM EXCESSIVE HEAT AND SECURED TO PROTECT FROM CHAFFING AND ABRASION. RECHECK ALL ELECTRICAL LINES, SECURE AS NECESSARY.

Checking Pump Noise!

NOTE: Each AirDog® has been manufactured in a Quality Controlled process and fully tested for operation and performance before shipment. This is a smooth running system. However, if any fuel fitting on the vacuum side, between the fuel tank and the AirDog® or the pre-filter, has been left loose during the installation process, the system may suck air at an excessive rate and will be very noisy. To check for this problem, unscrew the pre-filter 3 or 4 full turns and activate the AirDog® by turning the ignition switch to on. If the AirDog® runs quietly, then excessive air from a loose fitting or leaking pre-filter seal is most likely the reason for the excessive noise. Correct as necessary.

- A. The seal groove in the pre-filter is a snug fit and on occasion the seal has been found to not be fully seated. Remove the pre-filter, remove the seal from the top of the nut plate. Clean and lubricate the seal groove. Carefully replace the seal in the groove. Be sure to fully seat the seal.
- B. Check the fittings, especially the quick connect at the tank.

Filter Service Recommendations

Plugging of either the fuel filter or the water separator will cause low fuel pressure and low flow to the engine. If a low fuel pressure issue exists, replace the fuel filter. Typical fuel filter life is 15-20k miles depending on fuel quality.



The Water Separator

Replace the water separator every other time you change the Fuel Filter or if it becomes damaged or plugged. It is suggested to check/drain the water separator every three months or as needed should you experience excessive 'water in fuel' conditions. When installing the water separator, be sure to clean the underside of the AirDog® base. Follow the instructions printed on the pre-filter for proper tightening procedures.

NOTICE

Be extremely careful to prevent any contaminants or debris from entering the pre-filter when removing it for cleaning! Large debris will jam the Gerotor and cause the fuse to blow. This is not a warranty item. Should this happen, you can easily put the system back into working order. See the instructions on "How to clean the Gerotor" for proper procedures.

The Fuel Filter

Remove the fuel filter by turning it counter clockwise. **DO NOT** pre-fill the fuel filter with fuel. The AirDog® will fill the filter and prime the system automatically. Follow the instructions on the filter for proper tightening procedures.

NOTICE

Dispose of waste fuel and used filters properly to protect OUR environment.

CLEANING DEBRIS/CHECKING FOR DAMAGE IN/TO THE GEROTOR ASSEMBLY

STEP 1: Remove the four (4) socket head cap screws that secure the Gerotor cap using a 3/16 allen wrench.

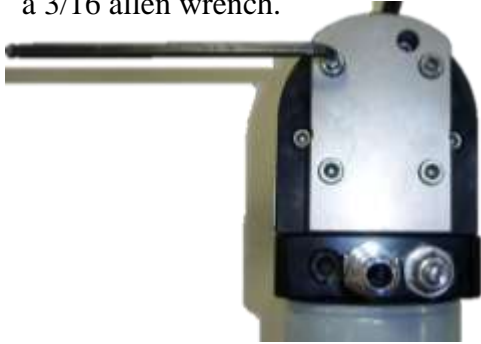

STEP 2: Carefully remove the O-rings you will need to reuse them.



STEP 3: Remove and clean the Gerotor. Be very careful to not damage the Gerotor.

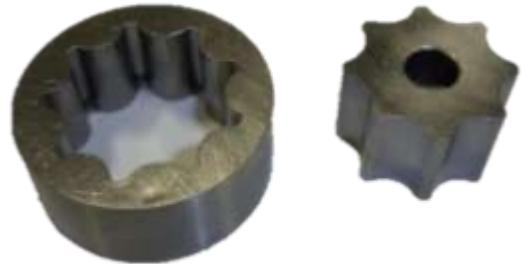

STEP 4: Remove the O-rings and clean/inspect the inside of the Gerotor pocket.



STEP 5: Reinstall the center gear.



STEP 6: Align and install the outer gear and O-rings.



STEP 7: Install the Gerotor Cap. Be very careful not to dislodge or pinch the O-rings.



STEP 8: Loosely assemble the cap screws. Torque the cap screws in an opposing pattern.

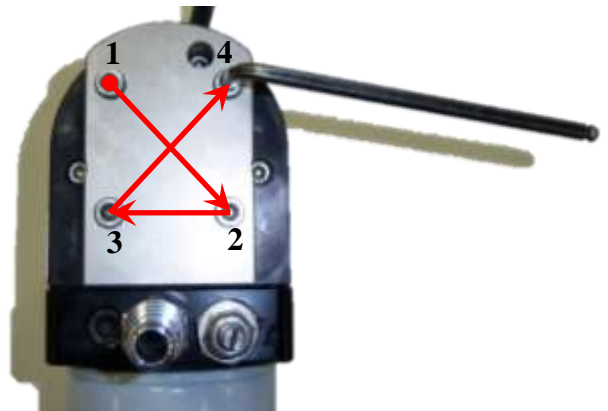

If there is damaged found to either the Gerotor, Gerotor pocket, or O-rings, call into AirDog® Tech Support for further assistance.

AirDog® II-5G ADJUSTABLE FUEL PRESSURE REGULATOR

The AirDog® II-5G rises to a new level of performance with an adjustable diaphragm fuel pressure regulator. This regulator offers more consistent fuel pressure and allows for higher flow rates at pressure. This regulator can also be boost compensated to battle any pressure drops under wide open throttle. The boost compensation kit, P/N AD-BOOSTCOMP, is sold separately.

PRESSURE ADJUSTMENT FOR THE DURAMAX

Loosen the Jam Nut with a 5/8 or 9/16 wrench

Use a 3/16 allen to adjust the pressure regulator

Re-torque after adjustment



PRESSURE ADJUSTMENT

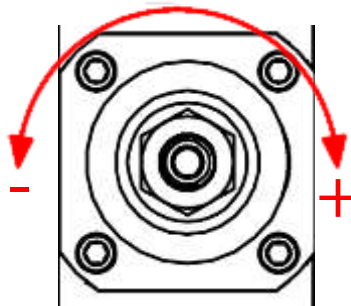

PRE-SET AT 8-10PSI FROM FACTORY



Turn the adjuster screw counter-clockwise to reduce the output pressure or clockwise to increase the pressure. Be sure to re-torque the jam nut after adjusting the regulator. **IT IS STRONGLY RECOMMENDED TO ADJUST THE PRESSURE WHILE USING A FUEL PRESSURE GAUGE. TOO MUCH OR TOO LITTLE PRESSURE MAY CAUSE DAMAGE TO THE INJECTION SYSTEM!**

Every AirDog II-5G has a 90-degree brass fitting in the pump to where you can add a fuel pressure gauge or fuel pressure sending unit for an electric gauge.



PUREFLOW AIRDOG *LIFETIME LIMITED EXPRESS WARRANTY*

FOR
Covered PureFlow AirDog I, II and Raptor Systems

IMPORTANT NOTICE

TO ACTIVATE YOUR PUREFLOW AIRDOG WARRANTY, YOU MUST COMPLETE AND MAIL YOUR WARRANTY CARD TO PUREFLOW AIRDOG WITH A COPY OF YOUR ORIGINAL SALES RECEIPT WITHIN 30 DAYS OF PURCHASE. FAILURE TO COMPLETE AND SUBMIT YOUR WARRANTY CARD WILL RESULT IN A WARRANTY PERIOD OF THE COVERED PRODUCE TO ONE (1) YEAR FROM THE DATE OF PURCHASE.

PureFlow AirDog (hereafter collectively, "SELLER") warrants and guarantees only to the Original Purchaser (hereafter collectively, BUYER) that All PureFlow AirDog Filtered Systems (hereafter collectively, PRODUCT) shall be free from defects of materials and workmanship in the manufacturing process for as long as the BUYER owns the PRODUCT.

The Lifetime Limited Express Warranty is limited to the PRODUCT purchased by the original BUYER of the PRODUCT and limited solely to the parts contained within the PRODUCT and EXCLUDES ALL ELSE INCLUDING FILTERS AND WATER SEPARATORS. Any PRODUCT that is in question of Warranty must be returned, shipped prepaid, to PureFlow AirDog. All Warranty claims are subject to the approval of PureFlow AirDog. If it is determined that a Warranty claim exists, PureFlow AirDog will, at its sole discretion, replace the defective PRODUCT with a comparable PRODUCT, repair the defective PRODUCT, or refund the BUYER'S purchase price in exchange for the PRODUCT. Repairs or replacements are warranted for only the remainder of the original warranty period and only to the original BUYER.

Under no circumstances shall the SELLER be liable for any labor charged or travel time incurred in the diagnosis for defects, removal, or reinstallation of the PRODUCT, or any contingent expense.

Under no circumstances will the SELLER be liable for any damage or expense incurred by reason of the use or sale of the PRODUCT.

Other than expressly set forth herein, the SELLER shall in no way be responsible for the proper or improper use and service of the PRODUCT. In no event shall the SELLER be liable for any special, incidental, indirect or consequential damages of any kind or nature, whether or not the BUYER of the PRODUCT was advised of the possibility of damage or harm, arising or resulting from the use or performance of the PRODUCT and BUYER hereby waives the right to any and all such claims.

BUYER, acknowledges that he/she is not relying on SELLER'S skill or judgment to select or furnish goods suitable for any particular purpose and that SELLER has no liability that will extend beyond the scope of the LIMITED EXPRESS WARRANTY contained herein, and BUYER hereby waives all remedies or liabilities, expressed or implied, arising by operation of law or otherwise. (including, without limitation, any obligation of SELLER with respect to fitness for any particular purpose; merchantability; and special, incidental, indirect or consequential damages) or whether or not occasioned by SELLER'S negligence.

SELLER disclaims any warranty and expressly disclaims any liability for personal injury or damages related to BUYER'S use of the PRODUCT. BUYER acknowledges and agrees that the disclaimer of any liability for personal injury is a material term for this agreement and BUYER agrees to indemnify SELLER and hold SELLER harmless from any claim related to the PRODUCT and its use or performance. Under no circumstances will SELLER be liable for any damages, liabilities, costs or expenses incurred as a result of or by reason of use, performance or sale of the PRODUCT, including without limitation, any damages, liabilities, costs or expenses incurred by reason of BUYER'S negligence related to those uses of the PRODUCT.

The proper installation of the PRODUCT is the sole responsibility of the BUYER. The SELLER assumes no liability regarding improper installation or misapplication of the PRODUCT.

SELLER hereby provides the following limited warranty as to description, quality, merchantability, fitness for the PRODUCT'S purpose, productiveness, or any other matter of SELLER'S PRODUCT sold herewith. The SELLER shall be in no way responsible for the open use and service of the PRODUCT and the BUYER hereby waives all rights other than those expressly written herein. This Warranty shall not be extended or varied except by a written instrument signed by SELLER and BUYER.

IN THE EVENT THAT THE BUYER DOES NOT AGREE WITH THIS AGREEMENT, THE BUYER MAY PROMPTLY RETURN THE PRODUCT, IN A NEW AND UNUSED CONDITION, WITH A DATED PROOF OF PURCHASE, TO THE PLACE OF PURCHASE WITHIN THIRTY (30) DAYS FROM THE DATE OF PURCHASE FOR A FULL REFUND. THE BUYER AGREES THAT THE INSTALLATION OF THIS PRODUCT CONFIRMS THE BUYER HAS READ AND UNDERSTANDS THIS AGREEMENT AND ACCEPTS THE TERMS AND CONDITIONS OF THIS AGREEMENT.

Warranty Procedure

In the unlikely event a warranty appears as if it may be warranted, the following steps are taken:

- 1 The customer discussed the symptoms of the problem with a PureFlow AirDog Technician. The customer is to have the system Serial Number and Model Number available for the Technician when the call is made. This will expedite all steps of the process.
- 2 The customer performs any and all tests requested by the PureFlow AirDog Technician. This is done to isolate the potential problem while eliminating potential installation or maintenance related issues,
- 3 If the PureFlow AirDog Technician determines based on the customer feedback concerning the requested testing that system may be at fault, the customer is advised that all returned pumps are tested upon arrival and should this returned pump perform at design criteria upon arrival, the customer will be charged a \$50.00 fee.
- 4 The PureFlow AirDog Technician will first request the customer's phone number in the event the phone call is accidentally disconnected and then transfer the customer to a PureFlow AirDog Customer Service Representative. Should a Customer Service Representative not be available, the Technician will offer the Customer the option to hold, call back, or receive a return call.
- 5 The PureFlow AirDog Customer Service Representative will check to determine if the customer's Warranty Registration Card is on file.
 - a. If no Warranty Registration is found, the customer will be required to supply the original purchase receipt showing the purchase date.
 - b. If no Warranty Registration is found, the customer will be advised of the options should the system in question is out of the default warranty period (1 year).
- 6 The PureFlow AirDog Customer Service Representative will request the customer information, including: Name, Address, Phone Number, Model Number, Serial Number, Year / Make / Model of vehicle, Name of Dealer purchased from, Purchase Date, Description of Problem, Customers' understanding of the resolution, and customer credit card information.
- 7 PureFlow AirDog will cover Ground Shipping charges to ship the replacement unit and will include a prepaid shipping label for the return of the defective unit. Any additional items ordered at the time of the replacement shipment will include their portion of the shipping cost.
- 8 A period of 15 Calendar Days from the time of shipment is provided for the receipt of the defective unit at the PureFlow AirDog facility. Failure to return ship the defective unit to arrive within the defined time period will result in a charge of \$250.00 against the customer's credit card as the purchase cost of the defective unit.

Revised: September 8, 2025