

#19

AirDog®

FUEL PREPARATOR®

DF-165-5G

PATENT PROTECTED:

<https://pureflowairdog.com/p-35853-patents.html>

1989-1993 CUMMINS INSTALLATION INSTRUCTIONS

**PLEASE READ AND CHECK CONTENTS
BEFORE INSTALLATION**



**PUREFLOW AIRDOG
705 W MAUSOLEUM RD.
SHELBYVILLE, IN 46176**

**877-421-3187
PUREFLOWAIRDOG.COM**

TABLE OF CONTENTS

SECTION	DESCRIPTION	PAGE
1	Table of Contents	2
2	Introduction	3
3	Safety Guidelines	4
4	Pre-Installation Checks	5
5	Parts List	6
6	Bolt Kit Parts List	7
7	Installation Illustration	8
8	Pump Fitting Installation	9
9	Installing the Pump on the Bracket System	10
10	Mounting the Pump on the Truck Frame	11
11	Fuel Line Assembly Overview	14
12	Fuel Engine Supply Line (From the AirDog® Engine Port to the VE Injection Pump.)	15
13	Fuel Return Line (From the AirDog® R Port to the Fuel Tank)	17
14	Fuel Suction Line DF-165-5G (From the WAP109 High Flow Suction Tube to the AirDog® Inlet port)	18
15	Disabling or Removing the Factory Mechanical Pump	25
16	Wiring Harness	26
17	Initial Startup	29
18	Fuel Filter Maintenance	30
19	Cleaning the Gerotor Assembly	31
20	Adjusting Fuel Pressure	32
21	Warranty	33

Thank you for choosing AirDog® for your truck fueling needs!

AirDog® recommends that a certified diesel shop technician install this product. Please note, if the end user performs the installation, it is recommended they have basic knowledge on how electric fuel systems operate and function. Failure to properly set up this fuel system may result in a voided warranty. **If properly set up per these instructions, the pump head carries a lifetime warranty to the original purchaser. THIS WARRANTY IS NON-TRANSFERRABLE!**

The AirDog® II-5G uses an adjustable diaphragm fuel pressure regulator to regulate the fuel pressure to the injection system. The pressure for this application is preset from the factory at 13psi. If a different pressure is desired, go to page 32 for instructions on how to adjust the pressure. **WARNING: RUNNING THE PUMP ABOVE 75PSI WILL DECREASE THE LIFE OF THE PUMP SIGNIFICANTLY AND MAY VOID THE WARRANTY. MORE FUEL PRESSURE DOES NOT MEAN MORE FUEL FLOW!**

OVERVIEW ON HOW THE SYSTEM OPERATES

The AirDog® draws fuel from the tank from a high flow suction tube for the DF-165-5G. The fuel is pulled through a water separator before being pressurized through the Gerotor pump. The pressurized fuel is sent through the 2-micron fuel filter before being sent to the engine. The pump maintains pressure through a diaphragm fuel pressure regulator that recirculates fuel back through the water separator. The separated air from the diesel fuel is returned through a filler neck return tee.

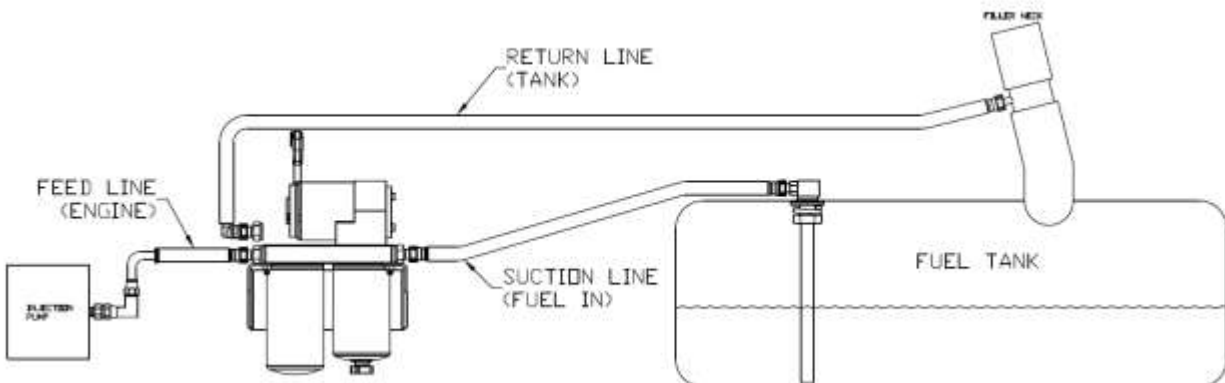



SAFETY INSTRUCTIONS

LEARN TO RECOGNIZE SAFETY INFORMATION

This is the safety alert symbol. When you see this symbol in this manual, **BE ALERT TO THE POTENTIAL FOR PERSONAL INJURY!**

Follow recommended precautions and safe operating practices.



UNDERSTANDING SIGNAL WORDS

A signal word-**DANGER**, **WARNING**, or **CAUTION** is used with the safety alert symbol.

DANGER indicates a hazardous situation which, if not avoided, **WILL** result in death or serious injury.



WARNING indicates a hazardous situation which if not avoided, **COULD** result in death or serious injury.



CAUTION indicates a hazardous situation which if not avoided, **COULD** result in minor or moderate injury



NOTICE indicates a preferred installation procedure.





The installation of your AirDog® can be made relatively easy by following the steps outlined in this manual, and:

1. Inventory the package components completely. Notify PUREFLOW AIRDOG® immediately of any missing or damaged parts! 317-421-3180
2. Read the installation manual completely. Understand how the system operates and understand the installation recommendations before beginning the installation.
3. The installation recommendations contained herein are suggested installation guidelines only. Individual installations may vary.
4. If any installation procedure is uncertain, contact PUREFLOW® AIRDOG for technical assistance.
5. When installing the AirDog® fuel lines be sure to keep the **ORIGINAL ENGINE RETURN LINE** connected as it is from the factory!

SAFETY GUIDELINES!



Please be sure to chock the vehicle's tires to prevent rolling



Please use proper supports when working beneath an elevated vehicle



Most diesel pickups have two (2) 12 volt batteries. Disconnect the battery cables to both batteries before proceeding with the AirDog® installation



Vehicle main framrails should not be drilled into or welded upon.



Wear safety glasses or shield when using tools such as drills and grinders or when using a punch or chisel



Prolonged exposure to loud noise can cause impairment or loss of hearing. Wear suitable hearing protective devices such as ear muffs or ear plugs to protect against loud noises.



Use common sense when routing fuel lines and electrical wiring. Keep them away from hot exhaust components and/or moving parts. Properly secure lines to prevent chaffing.

AirDog® Parts List

QTY	DESCRIPTION	Part Number	IMAGE
1	AirDog® II-5G	DF-165-5G	
1	AirDog® Mounting Bracket	001-3C-0004	
1	Mounting Bracket Hardware Kit	901-61-0102-PM-ED	
1	Frame Bracket Set Front	010-3C-0001	
1	Frame Bracket Set Back	010-3C-0002	
1	Wiring Harness	5E-2-010-HD	
1	Return Fuel Filler Tube (with 2 Clamps)	001-4A-1-0150	
1	High Flow Suction Tube	WAP109	
1	Bundle of Plastic Ties	5H-2-1-B	
1	Spacer	010-3C-0003-A-P	
1	20ft of Hose	HS20	
4	1/2" Straight Hose Quick Connect Fitting	FQC12S	
1	3/8" 90° Hose Quick Connect Fitting	FQC3890	
1	Customer Service O-ring Replacement Kit	901-05-0500	
3	1/2" Male SAE J2004 Quick Connect x 3/4 UNF	08J2044-3/4UNF	
1	3/8" Male J2004 Quick Connect x 7/16" UNF	06J2044716UNF	
1	-8 Male JIC to 12MM Male Injection Pump Fitting	001-4A-1-0002-S	
1	-8 Male JIC to -8 Female JIC 90° Fitting	4A-2-04-08-08-S	
1	-8 Female JIC to 1/2" Push-Lock Sweep 90° Fitting	4A-2-03-08-08-SL	
1	Vacuum Cap Hose Clamp	4C-2-1-10	
1	Vacuum Cap	HVC-467-16	

901-61-0102-PM-ED Bolt Kit Parts List









QTY	DESCRIPTION	IMAGE
4	1/4-20 X 1.25" SOCKET HEAD CAP SCREW	
4	1/4-20 NUT	
4	1/4" SPLIT-LOCK WASHER	
3	3/8-16 X 3.5" HEX HEAD CAP SCREW	
3	3/8-16 NUT	
3	3/8" SPLIT-LOCK WASHER	
4	5/16-18 X 3" FLAT SOCKET HEAD CAP SCREW	
4	5/16-18 NUT	
4	5/16" SPLIT-LOCK WASHER	

Illustration of Quick Connect Components



Installing the j2044 Quick Connect Fittings into the AirDog®II-5G Filter Base

TOOLS NEEDED:

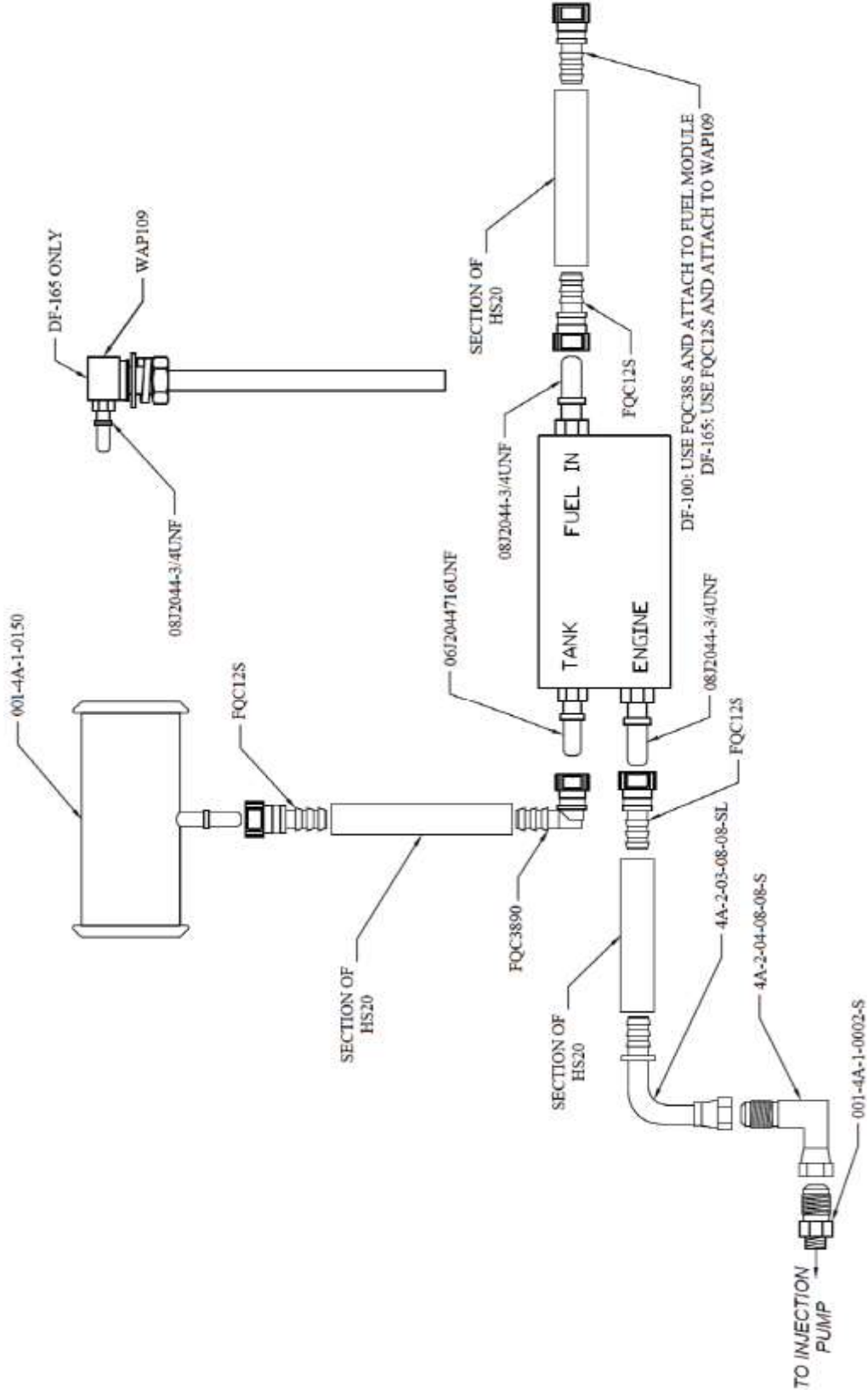
- Torque Wrench
- 7/8" Deep Socket
- 9/16" Deep Socket

PARTS NEEDED:

- 2x 08J2044-3/4UNF Fittings
- 06J2044716UNF Fitting

- 8-1. Dip the threaded end of the 08J2044-3/4UNF fitting into clean motor oil and hand-thread into the "ENGINE" and "INLET" ports of the AirDog®II-5G filter base as illustrated in figures 1, 2, and 3. Using a 7/8" deep socket, torque the fittings to 180in-lb or 15ft-lb.
- 8-2. Dip the threaded end of the 06J2044716UNF fitting into clean motor oil and hand-thread into the "RETURN" port of the the AirDog®II-5G filter base as illustrated in figures 1 and 2. Using a 9/16" deep socket, torque the fitting to 84in-lb or 7ft-lb.

NOTICE

DO NOT overtighten the fittings or damage may occur!

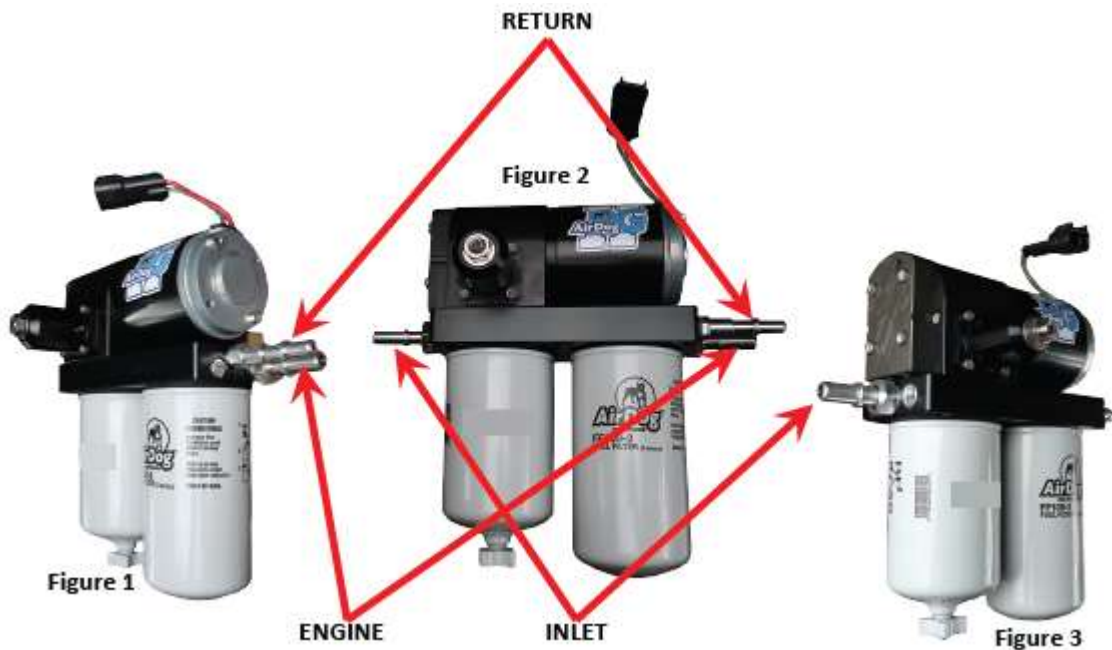

TOOLS NEEDED:

- 3/16 Allen
- 7/16 Socket or Wrench

PARTS NEEDED:

- 4x 1/4-20 x 1.25 Socket Head Cap Screws
- 4x 1/4" Lock Washers
- 4x 1/4-20 Nuts
- 001-3C-0004 Cradle Bracket

INSTALL THE AirDog® ON THE CRADLE BRACKET

- 9-1. First, take a look under the truck and pick a location where the pump and brackets will fit. Once the location is known, orient the pump in the cradle bracket with the suction line "FUEL IN" pointed towards the fuel tank.

NOTICE

We do recommend mounting the system on the inside of the frame if possible.

- 9-2. Using the above listed hardware, mount the AirDog® to the cradle bracket (001-3C-0004) in the desired orientation (inlet fitting facing the rear of the vehicle) using a 7/16 socket and 3/16 allen wrench.



Figure 4



Figure 5

TOOLS NEEDED:

- 3/16 Allen
- 1/2 Socket or Wrench

PARTS NEEDED:

- 4x 5/16-18 x 3.0" Flat Socket Head Cap Screws
- 4x 5/16" Lock Washers
- 4x 5/16-18 Nuts
- 010-3C-0001 Front Frame Sandwich Plate (Multiple Holes)
- 010-3C-0003-A-P Spacer Block

INSTALL THE AirDog® ON THE BRACKET SYSTEM

- 9-3. Mock the Front Frame Sandwich Plate (Multiple Holes) (010-3C-0001) on the frame and hold the pump assembly up to it. Be sure to choose a set of holes that tucks the pump up as far as possible without touching the bottom of the cab and use those holes to mount the pump in the next step.

NOTICE

Make sure the pump wires do not contact the bottom of the cab! Pump Failure due to rubbed through/shorted wiring from improper installation is not covered under warranty!



**BRACKET
TOP**



**BRACKET
BOTTOM**

Figure 6

9-4. Assemble the AirDog mounting bracket (001-3C-0004) to the frame bracket (010-3C-0001) using the spacer (010-3C-0003-A-P) as shown in figure 7 using the four bolts, lock washers, and nuts included in the mounting bracket hardware kit (figure 8). Properly torque all fasteners! The bracket assembly should look like figure 9. You will need a 3/16" Allen and a 1/2" Wrench. The finished assembly should look like figure 10.



Figure 7



Figure 8



Figure 9



Figure 10

Tools Needed:

- 2x 9/16" wrenches or socket wrenches

Parts Needed:

- 3x 3/8-16 x 3.5" Hex Head Cap Screw
- 3x 3/8 Lock Washers
- 3x 3/8-16 Nuts
- 010-3C-0002 Back Frame Sandwich Plate

INSTALL THE AirDog® ON THE TRUCK FRAMERAIL

- 10-1. Clamp the frame between the AirDog® bracket assembly and the back frame sandwich plate (010-3C-0002) using the 3/8" x 3.5" bolts, lock washers, and nuts included in the kit. Use two 9/16" wrenches to tighten. The two bolts go on top (Figure 11) and the single bolt goes on the bottom (Figure 12).

NOTICE

DO NOT overtighten the bolts or you may bend the brackets and chip the powdercoat! Only tighten until the lock washers are flat.

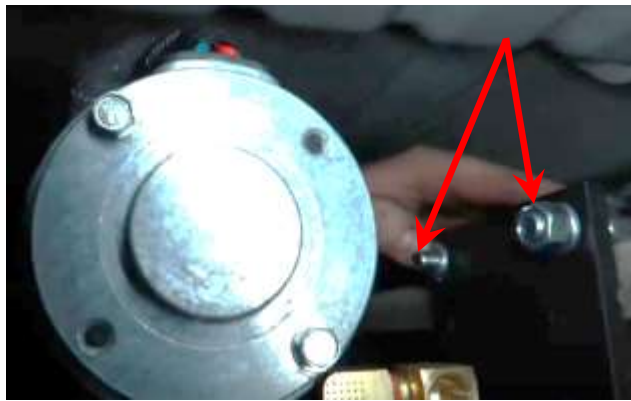

Figure 11

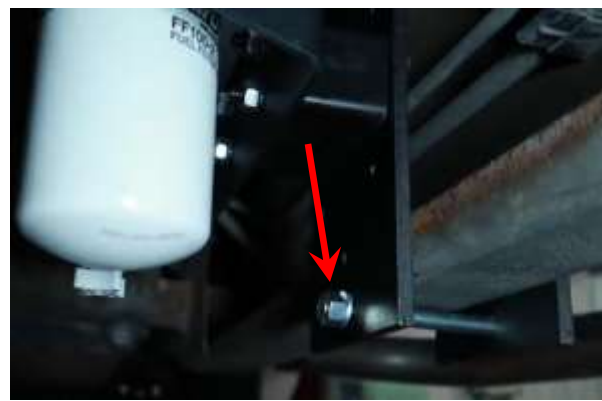

Figure 12



Figure 13



Figure 14

Fuel Line Assembly Overview

This kit includes a length of fuel line and separate fuel line ends to allow for much cleaner looking installations! Assemble the fuel lines as you install them per the instructions later in this manual. This section is for explanation purposes.

NOTICE

Do not pre-assemble the fuel lines or the lengths will not be correct!

- 11-1. Take the fuel line end and lubricate the barbed end with clean motor oil (Figure 15) and press it into the fuel line (HS20) until all of the barbs are covered (Figures 16 and 17). The fuel line end should look like Figure 17.



Figure 15



Figure 16



Figure 17

- 11-2. Now plug that fuel line with that fitting into the connection on the either the AirDog® or the truck where the manual calls it out.
- 11-3. Run the fuel line along the frame away from any hot or moving parts such as exhaust or the driveshaft (Figure 18). Cut the hose to length and insert the other fuel line end that the manual calls out into the fuel line as outlined in step 11-1.



Figure 18

NOTICE

Hose clamps are not needed for these push-lock connections! They may cause damage to the hose and cause leaks. Damage due to hose clamps is not covered under warranty!

Installing the Fuel Supply Line from the AirDog® to the Injection Pump

TOOLS NEEDED:

- 13/16" Wrench or Deep Socket
- 7/8" Wrench
- 24mm Wrench
- Clean Motor Oil or ATF
- Hose Cutters or a way to cut Fuel Line

PARTS NEEDED:

- 001-4A-1-0002-S Injection Pump Fitting
- 4A-2-04-08-08-S Hard 90deg Fitting
- 4A-2-03-08-08-SL Swoop 90deg Fitting
- FQC12S 1/2" Straight Quick Connect Fitting
- HS20 20ft Fuel Line

NOTICE

When installing the AirDog® fuel system, it is recommended to bypass the factory filter canister for optimum engine performance.

- 12-1. Remove the original factory fuel supply line at the fuel inlet port on the injector pump (Figure 19).



Figure 19



001-4A-1-0002-S



Figure 20

- 12-2. Install the 12mm x -8JIC (001-4A-1-0002-S) fitting with the seal washer supplied into the inlet port of the injector pump (Figure 20) once the original fitting is removed. **Do not over tighten the fitting. It may crack or break.** Either remove or bend the original supply line out of the way.
- 12-3. Next, install the fitting (4A-2-04-08-08-S) and be sure to turn it back slightly so the throttle linkage does not contact it. Refer to Figure 21.



Figure 21



12-4 Assemble one end of the hose (Reference section 11) using Fuel fitting 4A-2-03-08-08-SL

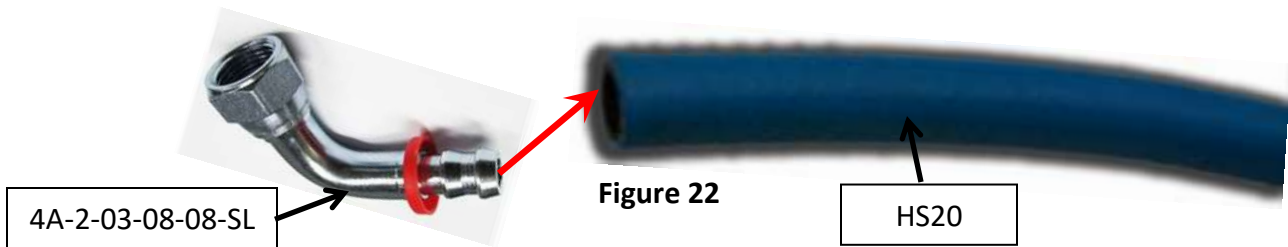

12-5. Now install the sloop 90deg fitting (4A-2-03-08-08-SL) as shown in Figure 23 (The hose that should be pressed on is not shown in this photo). Again, be sure the fitting does not contact the throttle linkage at all. **Do not overtighten as damage to the fittings may occur.**

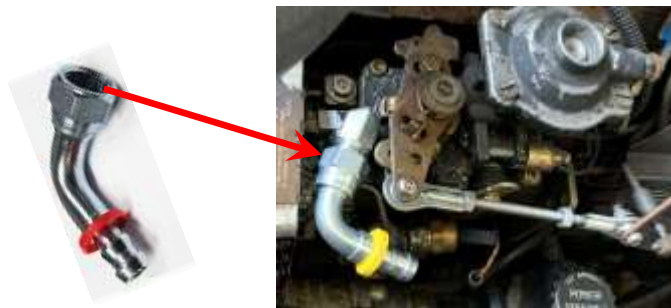
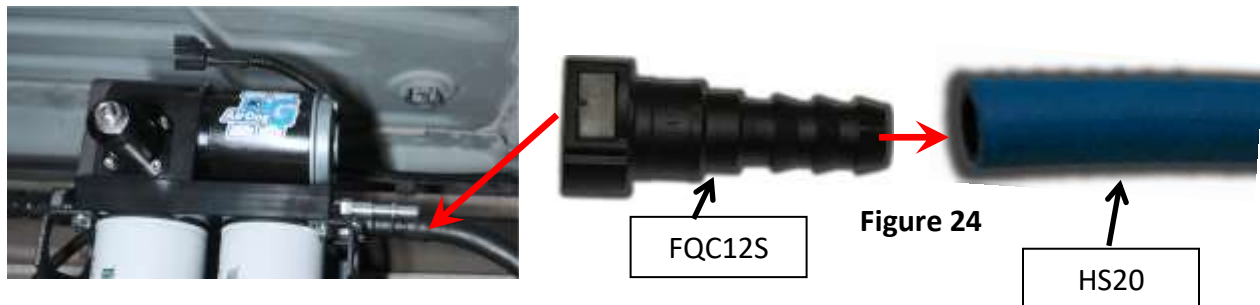

Figure 23

12-6. Run the fuel line along the frame as mentioned in step 11-3 to the “Engine” port in the AirDog®. Cut the fuel line to length and insert fuel line end FQC12S per step 11-1. Once the connector is installed, connect it to the male J2044 fitting in the “Engine” port in the AirDog®. A “click” will be heard once properly connected. Refer to figure 24.



AirDog® II-5G Fuel Return Line

TOOLS NEEDED:

- Clean Motor Oil or ATF
- Hose Cutters or a way to cut Fuel Line and the Filler Neck

PARTS NEEDED:

- 001-4A-1-0150 1.5" Filler Neck Return Tee with Clamps
- FQC3890 3/8" 90deg Quick Connect Fitting
- FQC12S 1/2" Straight Quick Connect Fitting
- HS20 20ft Fuel Line

- 13-1. Cut filler tube as illustrated in figure 25, removing **1/2** inch of hose. Loose assemble clamps on each end of filler tube before the filler tube is pushed in.
- 13-2. Insert the "Return Fuel Filler Tube" assembly (P/N 001-4A-1-0150) in the filler tube. **INSTALL THE FILLER TUBE WITH ARROWS, WHICH ARE STAMPED IN THE PART, POINTING TOWARD THE TANK!! SEE FIG 26.** Properly tighten clamps.

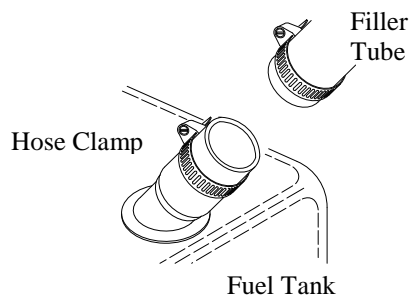

Figure 25



Figure 26



Figure 27

- 13-3. Assemble one end of the hose (Reference section 11) using Fuel line end FQC3890 and plug it into the "Return" J2044 fitting installed in the AirDog® (Figure 28). A "click" will be heard once the fitting is properly connected.

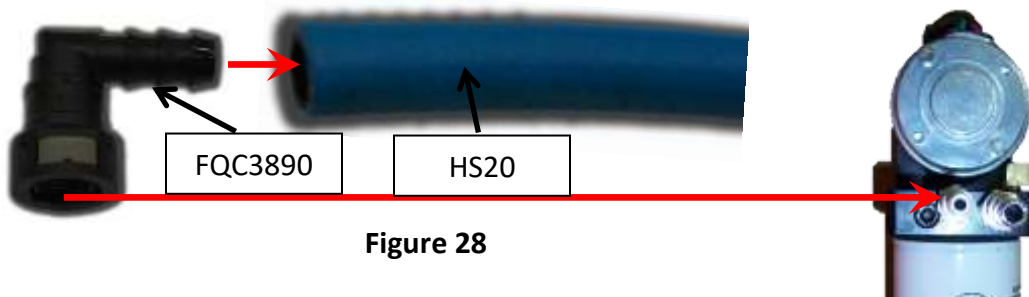

Figure 28

- 13-4. Run the fuel line along the frame as mentioned in step 11-3 to the filler neck tee. Cut the fuel line to length and insert fuel line end FQC12S per step 11-1. Once the connector is installed, connect it to the male J2044 fitting in the filler neck tee (001-4A-1-0150). A "click" will be heard once properly connected.



Figure 29

Fuel Suction Line for AirDog® II DF-165-5G

TOOLS NEEDED:

- Clean Motor Oil or ATF
- Hose Cutters or a way to cut Fuel Line
- 1" Hole Saw or Step Bit that can go up to 1"
- Hammer
- Large Screwdriver
- 7/8" Wrench or Deep Socket
- Tape Measure
- Permanent Marker
- Small Pilot Drill Bit
- 1/2" Drill Bit
- Cut-Off Wheel or Saw
- 1.5" Wrench or Adjustable Wrench

PARTS NEEDED:

- 2x FQC12S 1/2" Straight Quick Connect Fitting
- WAP109 High Flow Suction Tube
- HS20 20ft Fuel Line
- 08J2044-3/4UNF

- 14-1. Assemble one end of the suction fuel line (reference section 11) using fuel line end FQC12S. Once the end is pressed in, connect it to the J2044 fitting in the "Fuel In" port on the AirDog®. A "click" will be heard when the fitting is properly connected.

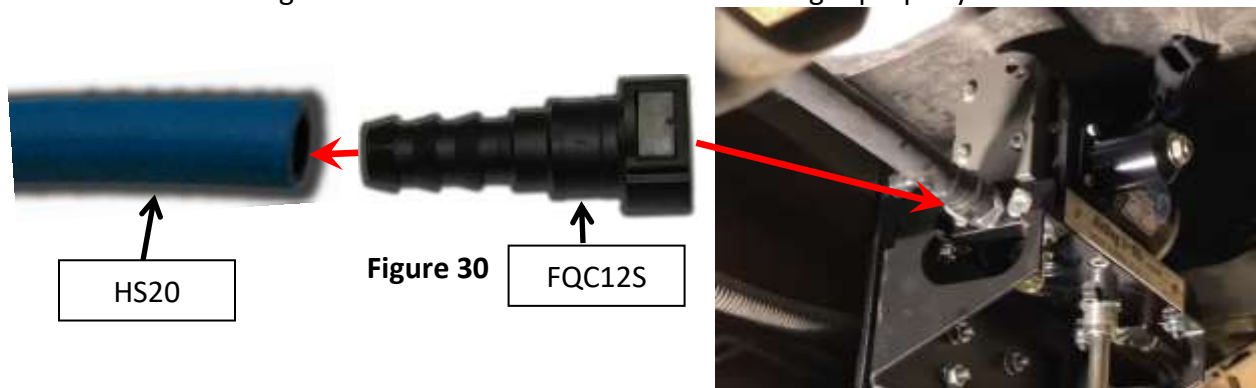

HIGH FLOW SUCTION TUBE

- 14-2. To install the WAP109, you will need to either drop the fuel tank or remove the truck bed.

NOTICE

Should you choose to drop the fuel tank, support the tank as it is when it is installed on the truck. If you let it rest flat on the floor, the tank may squash out and the suction tube will be too short after the tank is re installed in the truck. The suction tube, being cut too short may suck air as the fuel drops below 1/4 tank level.



WARNING: Failure to use proper jack stands while working under a vehicle may result in **SERIOUS INJURY OR DEATH!**



CAUTION: Failure to properly support the fuel tank upon removal/installation, may result in **INJURY!**

When Dropping the Tank, Always Remember, Safety First!

- 14-3. When dropping the tank, be sure to disconnect any attached fuel lines, sender wires, and fuel filler necks.



Figure 31



Figure 32



Figure 33

NOTICE

Should you choose to pull the pickup bed to access the tank. Be sure to disconnect the tail light wires, fuel tank filler tube, and any other accessories or components that may be secured to the frame and bed.

 **WARNING:** Failure to use proper jack stands while working under a vehicle may result in **SERIOUS INJURY OR DEATH!**

 **WARNING:** Failure to properly secure the bed while being removed/installed, may result in **SERIOUS INJURY OR DEATH!**



Figure 34



Figure 35

NOTICE

The fuel tank and truck bed used for the pictures are examples only and may not be exactly the same as your tank.

NOTICE

IMPORTANT: Select a location for the suction tube that has adequate clearance below the bed. Also consider that under hard acceleration, fuel will migrate toward the back of the fuel tank.

14-4. Once either the tank has been dropped or the bed removed, remove the collection basket as shown in figures 36 and 37.



Figure 36



Figure 37

Section 14 (Continued)

Suction Line DF-165-5G (From the WAP109 to the AirDog® Fuel In Port)

- 14-5. Select a spot to install the WAP109 draw straw. Be sure no bed supports or any cross members will contact the bulkhead fitting once the bed or tank is reinstalled. Drill a 1" hole using a step bit in your selected location (Figure 38). Hold a container below the drill point to catch debris as shown in figure 39.



Figure 38



Figure 39

- 14-6. Remove all burrs from the edge of the hole as shown in figure 40.



Figure 40

- 14-7. Install fitting 08J2044-3/4UNF into the bulkhead fitting of the WAP109 draw straw, as shown, using a 3/4 wrench. Tighten until the O-ring is no longer visible.

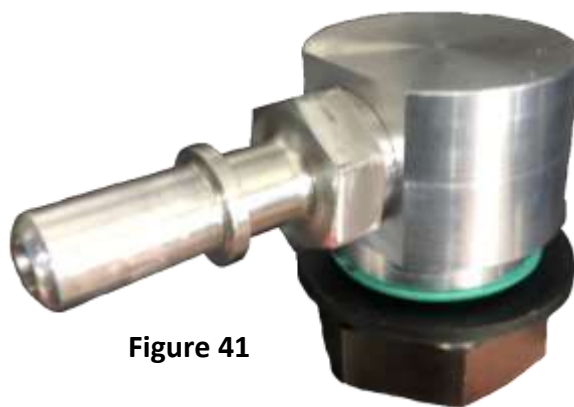

Figure 41

- 14-8. Mock the suction tube in the fuel tank and measure from the top of the fuel tank to the bottom of the green seal (Figure 42). Take this measurement and subtract a 1/4 inch. Measure from the bottom of the tube and mark the previous measurement as shown (Figure 43). The subtracted 1/4" will ensure the bottom of the straw is against the bottom of the tank once reinstalled.



Figure 42



Figure 43



- 14-9. Drill crossing pilot holes through the nylon tube, centered on the marked line, as shown (Figure 44). Use a larger bit (1/2" MAX) to open the holes up (Figure 45).

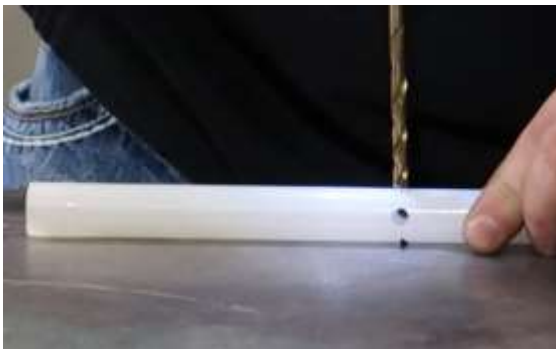

Figure 44



Figure 45

Section 14 (Continued)

Suction Line DF-165-5G (From the WAP109 to the AirDog® Fuel In Port)

- 14-10. Cut the fuel tube to the measured length (Figure 46). Deburr the tube (Figure 47) to be sure no debris get pulled into the fuel pump.



Figure 46



Figure 47

- 14-11. Install the trimmed WAP109 into the previously drilled hole in the tank and orient it in the desired direction (Figure 48). Make sure the bottom of the straw is contacting the bottom of the fuel tank. Install the hardware in this order: washer, lock washer, nut (Figure 49). Tighten the nut with a 1.5" wrench or adjustable wrench till snug (Figure 50). (Tank Cutaway is for reference. Access to straw is through module hole.)



Figure 48



Figure 49



Figure 50

- 14-12. Re-install the fuel module. Re-install the factory return line (The smaller of the two lines) to the proper port of the fuel module before the tank or bed is fully re-installed.

NOTICE

The factory engine return line **MUST** be reconnected to the fuel module! The factory engine feed port can be capped off with a vacuum cap. Refer to step 14-14.



Figure 51

Section 14 (Continued)

Suction Line DF-165-5G (From the WAP109 to the AirDog® Fuel In Port)

- 14-13. Run the fuel line along the frame as mentioned in step 11-3 to Suction Tube (WAP109). Cut the fuel line to length and insert fuel line end FQC12S per step 11-1. Once the fuel line end is pressed in, press it onto the quick connect fitting in the WAP109. A “Click” will be heard once properly connected.



Figure 52

- 14-14. Since the factory suction line is no longer used, cap the factory suction line with the supplied vacuum cap (P/N HVC-467-16) and hose clamp (P/N 4C-2-1-10)



Figure 53

Note: The module in this photo is not the same as your truck. It is for example only.

- 14-15. If the fuel tank was dropped to install the suction tube, re-install the fuel tank and make sure the factory fuel return line, fuel module wiring, and filler neck are reconnected. If the truck bed was removed, reinstall the bed and reconnect any ground wires, tail light wiring, and filler neck connections.

Factory Fuel Pump Modification or Removal

TOOLS NEEDED:

- 10mm Wrench or Socket

- 15-1. The engine mounted mechanical fuel pump can be disabled by removing the plunger from the pump that rides on the cam.
- 15-2. Remove the mechanical lift pump by removing the two bolts on each side of the pump. Remove the plunger. **Be very careful. DO NOT drop the plunger into the oil pan.**



Figure 54



Block Off Plate

(Not Included in Kit)

Figure 55



Figure 56

- 15-3. Either re-install the pump on the engine without the plunger or cover the mechanical pump port on the engine with a Big Block Chevy pump "block off" plate from your local auto parts store.

AirDog® Wiring Harness Install

WIRING DIAGRAM

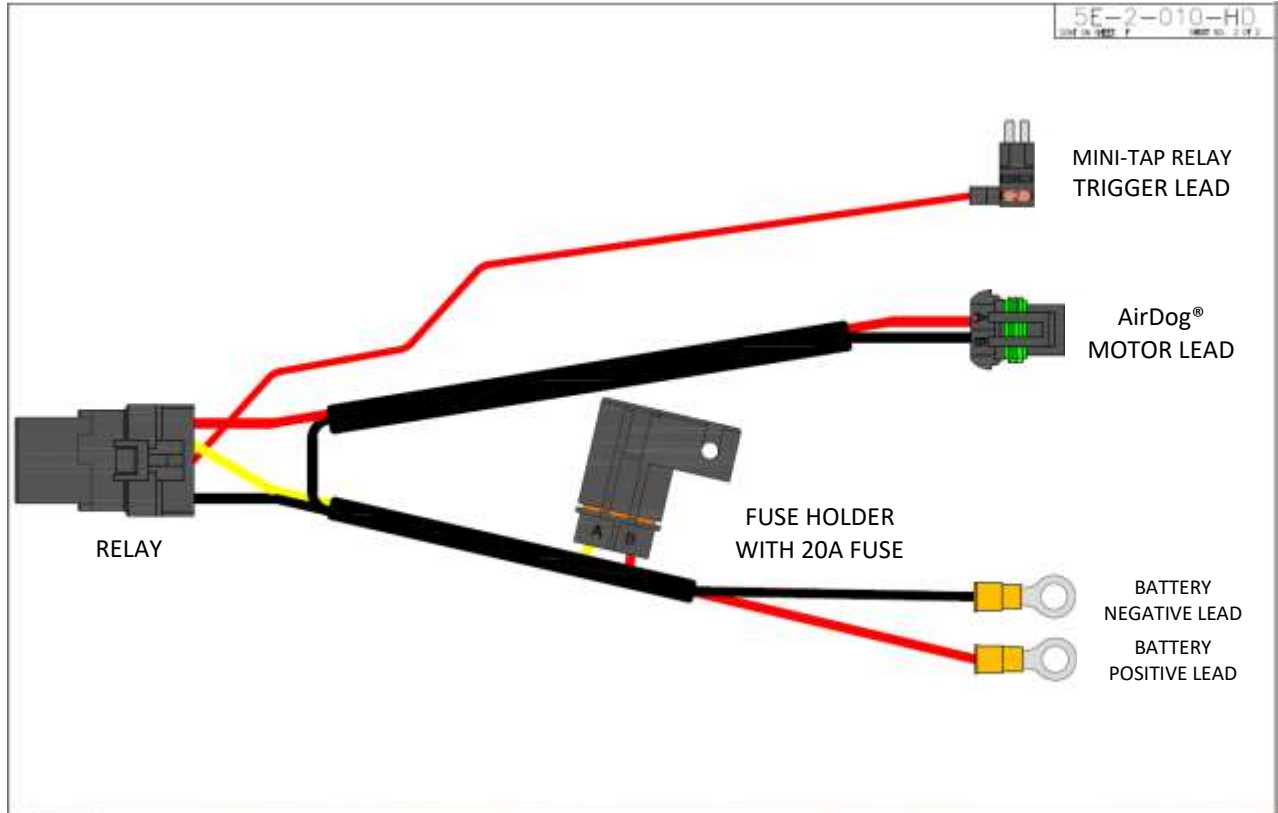

Figure 57

Secure the Relay and Fuse Holder to the Vehicle

- 16-1. Secure the relay and fuse holder to the vehicle. Be sure to rout the wires away from any moving parts. The relay is illustrated below in figure 58. The fuse holder mounting is the same concept.



Figure 58

Connecting the AirDog® Relay Control to the Fuse Panel

- 16-2. Route the red relay trigger wire, with the mini fuse tap attached, to the fuse panel. Connect it to a terminal that is hot when key on. Install the fuse that was removed to install the fuse tap into the open slot in the fuse tap before it is installed.



Figure 59

Connecting the Power Supply Leads to the Alternator or Battery

NOTICE

Connecting the power supply leads to the alternator instead of the battery will create a corrosion resistant connection.

- 16-3A. Route the Red and Black power supply leads to the alternator. Connect the Black (-) lead to the alternator Chassis Ground connection. Connect the Red (+) lead to the alternator Hot Lead going to the battery.

Black (-)

Red (+)



Figure 60

Replace the Protective Cover



Figure 61

Connecting the power supply leads Continued

- 16-3B. Should you choose to connect the power supply leads directly to the battery, connect the Red (+) led to the Positive (+) post of the driver's side battery. Connect the Black (-) lead to the Negative (-) post of the same battery.

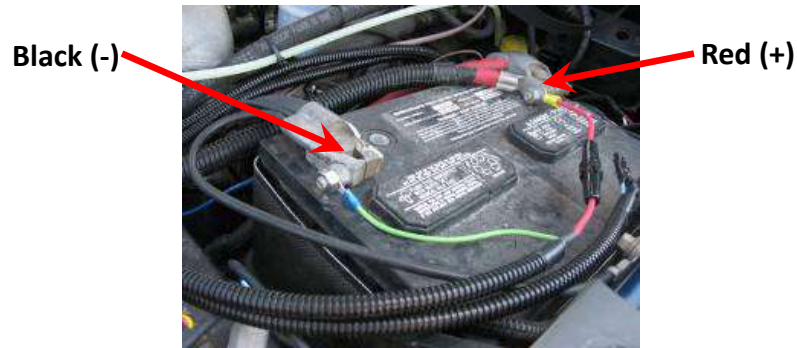

Figure 62

- 16-4. Route the wiring harness to the AirDog® and connect the 2 pin connector to the corresponding connector on the AirDog®.

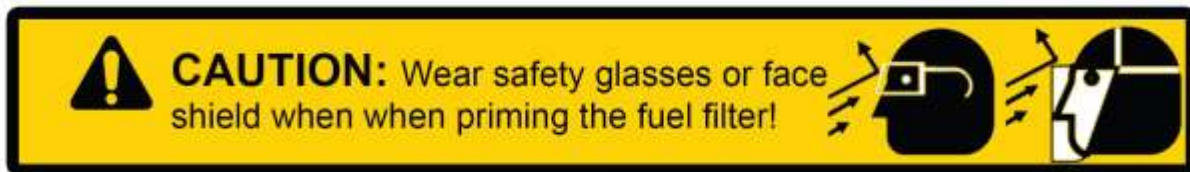

Figure 63

INITIAL START PROCEDURE

The AirDog® is a self-priming system, however, to prevent potential damage to the system, it is recommended to fill the pre-filter (Water Separator) with diesel fuel before initial startup.

- 17-1. Fill the water separator with diesel fuel.
- 17-2. Turn the starter key to the on/run position.
- 17-3. While the AirDog® is operating, bleed the air from system by loosening the fuel filter slightly. As soon as the system is purged of air and fuel is observed, quickly tighten the fuel filter.



NOTE: put a rag or shop towel over and around filter to prevent splatter. Catch all spilled fuel and dispose of properly.

- 17-4. Start the engine!

RECHECK ALL FUEL FITTINGS FOR LEAKAGE AND PROPERLY TORQUE. BE SURE ALL FUEL LINES ARE PROPERLY ROUTED TO PROTECT FROM EXCESSIVE HEAT AND SECURED TO PROTECT FROM CHAFFING AND ABRASION. RECHECK ALL ELECTRICAL LINES, SECURE AS NECESSARY.

Checking Pump Noise!

NOTE: Each AirDog® has been manufactured in a Quality Controlled process and fully tested for operation and performance before shipment. This is a smooth running system. However, if any fuel fitting on the suction side, between the fuel tank and the AirDog® or the pre-filter, has been left loose during the installation process, the system may suck air at an excessive rate and will be very noisy. To check for this problem, unscrew the pre-filter 3 or 4 full turns and activate the AirDog® by turning the ignition switch to on. If the AirDog® runs quietly, then excessive air from a loose fitting or leaking pre-filter seal is most likely the reason for the excessive noise. Correct as necessary.

- A. The seal groove in the pre-filter is a snug fit and on occasion the seal has been found to not be fully seated. Remove the pre-filter, remove the seal from the top of the nut plate. Clean and lubricate the seal groove. Carefully replace the seal in the groove. Be sure to fully seat the seal.
- B. Check the fittings, especially the quick connect at the tank.

FILTER SERVICE RECOMMENDATIONS

Plugging of either the fuel filter or the water separator will cause low fuel pressure and low flow to the engine. If a low fuel pressure issue exists, replace the fuel filter. Typical fuel filter life is 15-20k miles depending on fuel quality.



The Water Separator

Replace the water separator every other time you change the Fuel Filter or if it becomes damaged or plugged. It is suggested to check/drain the water separator every three months or as needed should you experience excessive 'water in fuel' conditions. When installing the water separator, be sure to clean the underside of the AirDog® base. Follow the instructions printed on the pre-filter for proper tightening procedures.

NOTICE

Be extremely careful to prevent any contaminants or debris from entering the pre-filter when removing it for cleaning! Large debris will jam the Gerotor and cause the fuse to blow. This is not a warranty item. Should this happen, you can easily put the system back into working order. See the instructions on "How to clean the Gerotor" for proper procedures.

The Fuel Filter

Remove the fuel filter by turning it counter clockwise. **DO NOT** pre-fill the fuel filter with fuel. The AirDog® will fill the filter and prime the system automatically. Follow the instructions on the filter for proper tightening procedures.

NOTICE

Dispose of waste fuel and used filters properly to protect OUR environment.

CLEANING DEBRIS/CHECKING FOR DAMAGE IN/TO THE GEROTOR ASSEMBLY

STEP 1: Remove the four (4) socket head cap screws that secure the Gerotor cap using a 3/16 allen wrench.

STEP 2: Carefully remove the O-rings you will need to reuse them.

STEP 3: Remove and clean the Gerotor. Be very careful to not damage the Gerotor.



STEP 4: Remove the O-rings and clean/inspect the inside of the Gerotor pocket.

STEP 5: Reinstall the center gear.

STEP 6: Align and install the outer gear and O-rings.



STEP 7: Install the Gerotor Cap. Be very careful not to dislodge or pinch the O-rings.

STEP 8: Loose assemble the cap screws. Torque the cap screws in an opposing pattern.

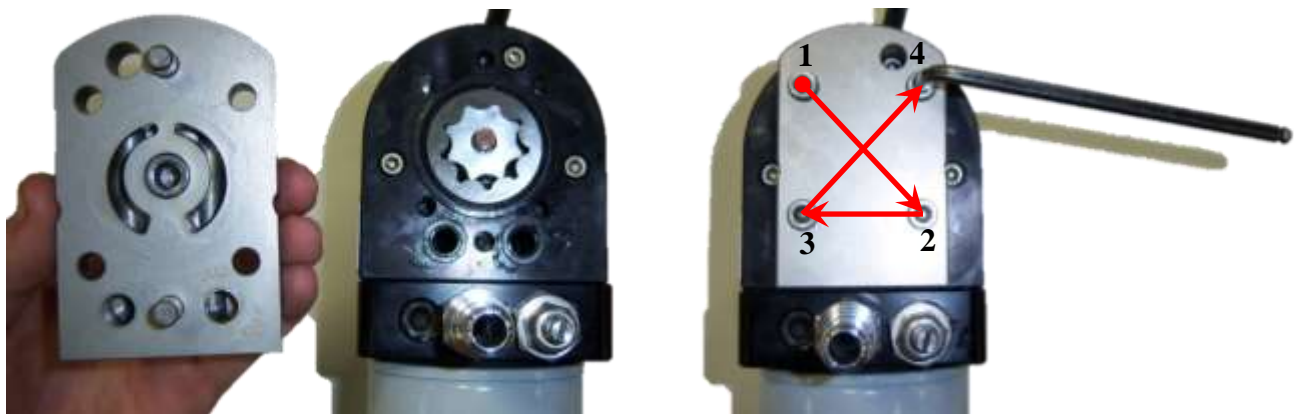

If there is damaged found to either the Gerotor, Gerotor pocket, or O-rings, call into AirDog® Tech Support for further assistance.

AirDog®II-5G ADJUSTABLE FUEL PRESSURE REGULATOR

The AirDog®II-5G rises to a new level of performance with an adjustable diaphragm fuel pressure regulator. This regulator offers more consistent fuel pressure and allows for higher flow rates at pressure. This regulator can also be boost compensated to battle any pressure drops under wide open throttle. The boost compensation kit, P/N AD-BOOSTCOMP, is sold separately.

PRESSURE ADJUSTMENT FOR THE VE CUMMINS

Loosen the Jam Nut with a 5/8 wrench
Re-torque after adjustment

Use a 3/16 allen to adjust the pressure
regulator

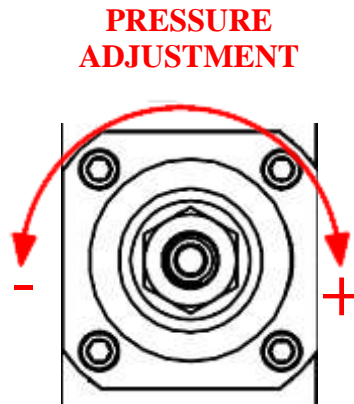

**PRE-SET AT 13PSI
FROM FACTORY**

Turn the adjuster screw counter-clockwise to reduce the output pressure or clockwise to increase the pressure. Be sure to re-torque the jam nut after adjusting the regulator. **IT IS STRONGLY RECOMMENDED TO ADJUST THE PRESSURE WHILE USING A FUEL PRESSURE GAUGE. TOO MUCH OR TOO LITTLE PRESSURE MAY CAUSE DAMAGE TO THE INJECTION SYSTEM!**

Every AirDog II-5G has a 90-degree brass fitting in the pump to where you can add a fuel pressure gauge or fuel pressure sending unit for an electric gauge.



PUREFLOW AIRDOG
LIFETIME LIMITED EXPRESS WARRANTY

FOR

Covered PureFlow AirDog I, II and Raptor Systems

IMPORTANT NOTICE

TO ACTIVATE YOUR PUREFLOW AIRDOG WARRANTY, YOU MUST COMPLETE AND MAIL YOUR WARRANTY CARD TO PUREFLOW AIRDOG WITH A COPY OF YOUR ORIGINAL SALES RECEIPT WITHIN 30 DAYS OF PURCHASE. FAILURE TO COMPLETE AND SUBMIT YOUR WARRANTY CARD WILL RESULT IN A WARRANTY PERIOD OF THE COVERED PRODUCE TO ONE (1) YEAR FROM THE DATE OF PURCHASE.

PureFlow AirDog (hereafter collectively, "SELLER") warrants and guarantees only to the Original Purchaser (hereafter collectively, BUYER) that All PureFlow AirDog Filtered Systems (hereafter collectively, PRODUCT) shall be free from defects of materials and workmanship in the manufacturing process for as long as the BUYER owns the PRODUCT.

The Lifetime Limited Express Warranty is limited to the PRODUCT purchased by the original BUYER of the PRODUCT and limited solely to the parts contained within the PRODUCT and EXCLUDES ALL ELSE INCLUDING FILTERS AND WATER SEPARATORS. Any PRODUCT that is in question of Warranty must be returned, shipped prepaid, to PureFlow AirDog. All Warranty claims are subject to the approval of PureFlow AirDog. If it is determined that a Warranty claim exists, PureFlow AirDog will, at its sole discretion, replace the defective PRODUCT with a comparable PRODUCT, repair the defective PRODUCT, or refund the BUYER'S purchase price in exchange for the PRODUCT. Repairs or replacements are warranted for only the remainder of the original warranty period and only to the original BUYER.

Under no circumstances shall the SELLER be liable for any labor charged or travel time incurred in the diagnosis for defects, removal, or reinstallation of the PRODUCT, or any contingent expense.

Under no circumstances will the SELLER be liable for any damage or expense incurred by reason of the use or sale of the PRODUCT.

Other than expressly set forth herein, the SELLER shall in no way be responsible for the proper or improper use and service of the PRODUCT. In no event shall the SELLER be liable for any special, incidental, indirect or consequential damages of any kind or nature, whether or not the BUYER of the PRODUCT was advised of the possibility of damage or harm, arising or resulting from the use or performance of the PRODUCT and BUYER hereby waives the right to any and all such claims.

BUYER, acknowledges that he/she is not relying on SELLER'S skill or judgment to select or furnish goods suitable for any particular purpose and that SELLER has no liability that will extend beyond the scope of the LIMITED EXPRESS WARRANTY contained herein, and BUYER hereby waives all remedies or liabilities, expressed or implied, arising by operation of law or otherwise.(including, without limitation, any obligation of SELLER with respect to fitness for any particular purpose; merchantability; and special, incidental, indirect or consequential damages) or whether or not occasioned by SELLER'S negligence.

SELLER disclaims any warranty and expressly disclaims any liability for personal inquiry or damages related to BUYER'S use of the PRODUCT. BUYER acknowledges and agrees that the disclaimer of any liability for personal injury is a material term for this agreement and BUYER agrees to indemnify SELLER and hold SELLER harmless from any claim related to the PRODUCT and its use or performance. Under no circumstances will SELLER be liable for any damages, liabilities, costs or expenses incurred as a result of or by reason of use, performance or sale of the PRODUCT, including without limitation, any damages, liabilities, costs or expenses incurred by reason of BUYER'S negligence related to those uses of the PRODUCT.

The proper installation of the PRODUCT is the sole responsibility of the BUYER. The SELLER assumes no liability regarding improper installation or misapplication of the PRODUCT.

Section 21 (Continued)

Warranty

SELLER hereby provides the following limited warranty as to description, quality, merchantability, fitness for the PRODUCT'S purpose, productiveness, or any other matter of SELLER'S PRODUCT sold herewith. The SELLER shall be in no way responsible for the open use and service of the PRODUCT and the BUYER hereby waives all rights other than those expressly written herein. This Warranty shall not be extended or varied except by a written instrument signed by SELLER and BUYER.

IN THE EVENT THAT THE BUYER DOES NOT AGREE WITH THIS AGREEMENT, THE BUYER MAY PROMPTLY RETURN THE PRODUCT, IN A NEW AND UNUSED CONDITION, WITH A DATED PROOF OF PURCHASE, TO THE PLACE OF PURCHASE WITHIN THIRTY (30) DAYS FROM THE DATE OF PURCHASE FOR A FULL REFUND. THE BUYER AGREES THAT THE INSTALLATION OF THIS PRODUCT CONFIRMS THE BUYER HAS READ AND UNDERSTANDS THIS AGREEMENT AND ACCEPTS THE TERMS AND CONDITIONS OF THIS AGREEMENT.

Warranty Procedure

In the unlikely event a warranty appears as if it may be warranted, the following steps are taken:

- 1 The customer discussed the symptoms of the problem with a PureFlow AirDog Technician. The customer is to have the system Serial Number and Model Number available for the Technician when the call is made. This will expedite all steps of the process.
- 2 The customer performs any and all tests requested by the PureFlow AirDog Technician. This is done to isolate the potential problem while eliminating potential installation or maintenance related issues,
- 3 If the PureFlow AirDog Technician determines based on the customer feedback concerning the requested testing that system may be at fault, the customer is advised that all returned pumps are tested upon arrival and should this returned pump perform at design criteria upon arrival, the customer will be charged a \$50.00 fee.
- 4 The PureFlow AirDog Technician will first request the customer's phone number in the event the phone call is accidentally disconnected and then transfer the customer to a PureFlow AirDog Customer Service Representative. Should a Customer Service Representative not be available, the Technician will offer the Customer the option to hold, call back, or receive a return call.
- 5 The PureFlow AirDog Customer Service Representative will check to determine if the customer's Warranty Registration Card is on file.
 - a. If no Warranty Registration is found, the customer will be required to supply the original purchase receipt showing the purchase date.
 - b. If no Warranty Registration is found, the customer will be advised of the options should the system in question is out of the default warranty period (1 year).
- 6 The PureFlow AirDog Customer Service Representative will request the customer information, including: Name, Address, Phone Number, Model Number, Serial Number, Year / Make / Model of vehicle, Name of Dealer purchased from, Purchase Date, Description of Problem, Customers' understanding of the resolution, and customer credit card information.
- 7 PureFlow AirDog will cover Ground Shipping charges to ship the replacement unit and will include a prepaid shipping label for the return of the defective unit. Any additional items ordered at the time of the replacement shipment will include their portion of the shipping cost.
- 8 A period of 15 Calendar Days from the time of shipment is provided for the receipt of the defective unit at the PureFlow AirDog facility. Failure to return ship the defective unit to arrive within the defined time period will result in a charge of \$250.00 against the customer's credit card as the purchase cost of the defective unit.

Revised: August 20, 2025