

#7

# **AirDog**<sup>®</sup> **FP-100-4G** **FUEL PREPATOR**<sup>®</sup> **FP-150-4G**

**PATENT PROTECTED:**

<https://pureflowairdog.com/p-35853-patents.html>

# **2004.5-2024 CUMMINS**

## **INSTALLATION INSTRUCTIONS**

### **PLEASE READ AND CHECK CONTENTS BEFORE INSTALLATION**



**PUREFLOW AIRDOG**  
705 W MAUSOLEUM RD.  
SHELBYVILLE, IN 46176

877-421-3187  
**PUREFLOWAIRDOG.COM**

<b>SECTION</b>	<b>DESCRIPTION</b>	<b>PAGE</b>
1	TABLE OF CONTENTS	2
2	INTRODUCTION	3
3	SAFETY GUIDELINS	4
4	PRE-INSTALLATION CHECKS	5
5	PARTS LIST	6
6	INSTALLATION ILLUSTRATION	8
7	AIRDOG® PUMP FITTING INSTALLATION	9
8	INSTALLING THE AIRDOG® ON THE BRACKET SYSTEM	10
9	INSTALLING THE AIRDOG® ON THE TRUCK FRAME	13
10	FUEL LINE ASSEMBLY OVERVIEW	15
11a	ENGINE LINE (FROM AIRDOG® TO INJECTION PUMP) 5.9L	16
11b	ENGINE LINE (FROM AIRDOG® TO INJECTION PUMP) 6.7L	17
12	RETURN LINE (FROM AIRDOG® TO THE FUEL TANK)	18
13	SUCTION LINE (FROM THE FUEL TANK TO THE AIRDOG® INLET)	19
14	WIRING HARNESS	26
15	INITIAL STARTUP PROCEDURE	29
16	FILTER SERVICE	30
17	FUEL PRESSURE REGULATOR SERVICE	31
18	CLEANING THE GEROTOR ASSEMBLY	32
19	WARRANTY	33

## Thank you for choosing AirDog® for your truck fueling needs!

AirDog® recommends that a certified diesel shop technician install this product. Please note, if the end user performs the installation, it is recommended they have basic knowledge on how electric fuel systems operate and function. Failure to properly set up this fuel system may result in a voided warranty. **If properly set up per these instructions, the pump head carries a lifetime warranty to the original purchaser. THIS WARRANTY IS NON-TRANSFERRABLE!**

The Original AirDog® uses a ball and spring on the return side of the pump to regulate fuel pressure. The pressure for this application is 15-17psi. The fuel pressure is not adjustable other than stretching the spring for higher pressure or cutting the spring for lower pressure. If a different fuel pressure is desired, call 317-421-3180 and speak to an AirDog® Technician. We may have the pressure spring you are looking for.

### OVERVIEW ON HOW THE SYSTEM OPERATES

The AirDog® draws fuel from the tank from a high flow suction tube to bypass the fuel pump in the tank. The fuel is then pulled through a water separator before being pressurized through the Gerotor pump. The pressurized fuel is sent through the 2 micron fuel filter before being sent to the engine. The pump maintains pressure through a high flow ball and spring regulator behind the tank fitting in the filter base.

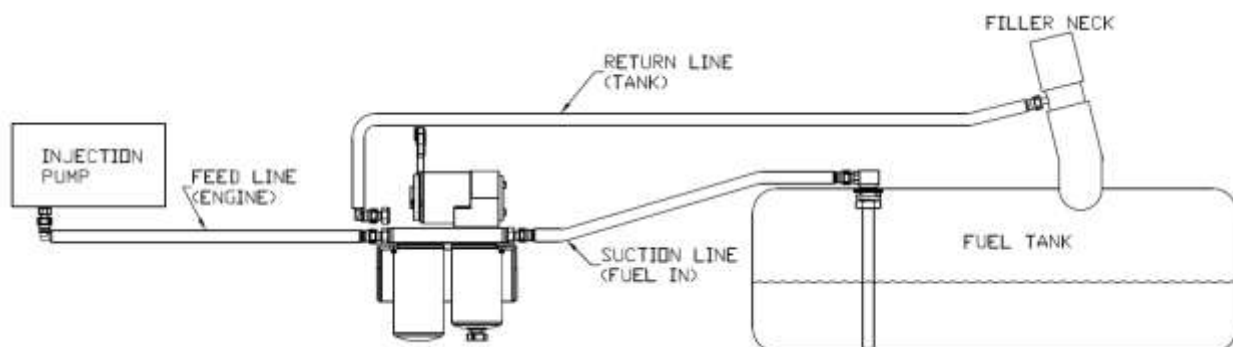



## SAFETY INSTRUCTIONS

### LEARN TO RECOGNIZE SAFETY INFORMATION

This is the safety alert symbol. When you see this symbol in this manual, **BE ALERT TO THE POTENTIAL FOR PERSONAL INJURY!**

Follow recommended precautions and safe operating practices.



### UNDERSTANDING SIGNAL WORDS

A signal word-**DANGER**, **WARNING**, or **CAUTION** is used with the safety alert symbol.

**DANGER** indicates a hazardous situation which, if not avoided, **WILL** result in death or serious injury.



**WARNING** indicates a hazardous situation which if not avoided, **COULD** result in death or serious injury.



**CAUTION** indicates a hazardous situation which if not avoided, **COULD** result in minor or moderate injury



**NOTICE** indicates a preferred installation procedure.





The installation of your AirDog® can be made relatively easy by following the steps outlined in this manual, and:

1. Inventory the package components completely. Notify PUREFLOW AIRDOG® immediately of any missing or damaged parts! 317-421-3180
2. Read the installation manual completely. Understand how the system operates and understand the installation recommendations before beginning the installation.
3. The installation recommendations contained herein are suggested installation guidelines only. Individual installations may vary.
4. If any installation procedure is uncertain, contact PUREFLOW® AIRDOG for technical assistance.
5. When installing the AirDog® fuel lines be sure to keep the **ORIGINAL ENGINE RETURN LINE** connected as it is from the factory!

### SAFETY GUIDELINES!



Please be sure to chock the vehicle's tires to prevent rolling



Please use proper supports when working beneath an elevated vehicle



Most diesel pickups have two (2) 12 volt batteries. Disconnect the battery cables to both batteries before proceeding with the AirDog® installation



Vehicle main framerrails should not be drilled into or welded upon.



Wear safety glasses or shield when using tools such as drills and grinders or when using a punch or chisel



Prolonged exposure to loud noise can cause impairment or loss of hearing. Wear suitable hearing protective devices such as ear muffs or ear plugs to protect against loud noises.











Use common sense when routing fuel lines and electrical wiring. Keep them away from hot exhaust components and/or moving parts. Properly secure lines to prevent chaffing.

**AirDog® Parts List**

<b>QTY</b>	<b>DESCRIPTION</b>	<b>Part Number</b>	<b>IMAGE</b>
1	<b>AirDog®</b>	FP-100-4G <i>Or</i> FP-150-4G	
1	<b>AirDog® Mounting Bracket</b>	001-3C-0004	
1	<b>Mounting Bracket Hardware Kit, Includes:</b>	901-61-0102-PM	
1	<b>Frame Bracket Front</b>	010-3C-0001	
1	<b>Frame Bracket Back</b>	010-3C-0002	
1	<b>Wiring Harness</b>	5E-2-014-HD	
1	<b>Return Fuel Filler Tube (with 2 Clamps)</b>	001-4A-1-0150	
1	<b>Bundle of Plastic Ties</b>	5H-2-1-B	
1	<b>High Flow Suction Tube</b>	WAP108	
1	<b>Spacer</b>	010-3C-0003-A-P	
1	<b>20ft of Hose</b>	HS20	
4	<b>1/2" Straight Hose Quick Connect End</b>	FQC12S	
2	<b>1/2" 90° Hose Quick Connect End</b>	FQC1290	
1	<b>12mm X 1/2" male SAE J2044 Fitting</b>	WAP102	
1	<b>Seal Washer (Assembles on WAP 102)</b>	1P-5-DS	
1	<b>Customer Service Oring Replacement Kit</b>	901-05-0103	
3	<b>1/2" Male SAE J2004 Quick Connect x 3/4" UNF</b>	08J2044-3/4UNF	
1	<b>Vacuum Cap</b>	HVC-467-16	
1	<b>Vacuum Cap Hose Clamp</b>	4C-2-1-10	

**901-61-0102-PM Bolt Kit Parts List**

QTY	DESCRIPTION	IMAGE
4	<b>1/4-20 X 1.25" SOCKET HEAD CAP SCREW</b>	
4	<b>1/4-20 NUT</b>	
4	<b>1/4" SPLIT-LOCK WASHER</b>	
3	<b>3/8-16 X 4.5" HEX HEAD CAP SCREW</b>	
3	<b>3/8-16 NUT</b>	
3	<b>3/8" SPLIT-LOCK WASHER</b>	
4	<b>5/16-18 X 3" FLAT SOCKET HEAD CAP SCREW</b>	
4	<b>5/16-18 NUT</b>	
4	<b>5/16" SPLIT-LOCK WASHER</b>	

### ILLUSTRATION OF QUICK CONNECT COMPONENTS

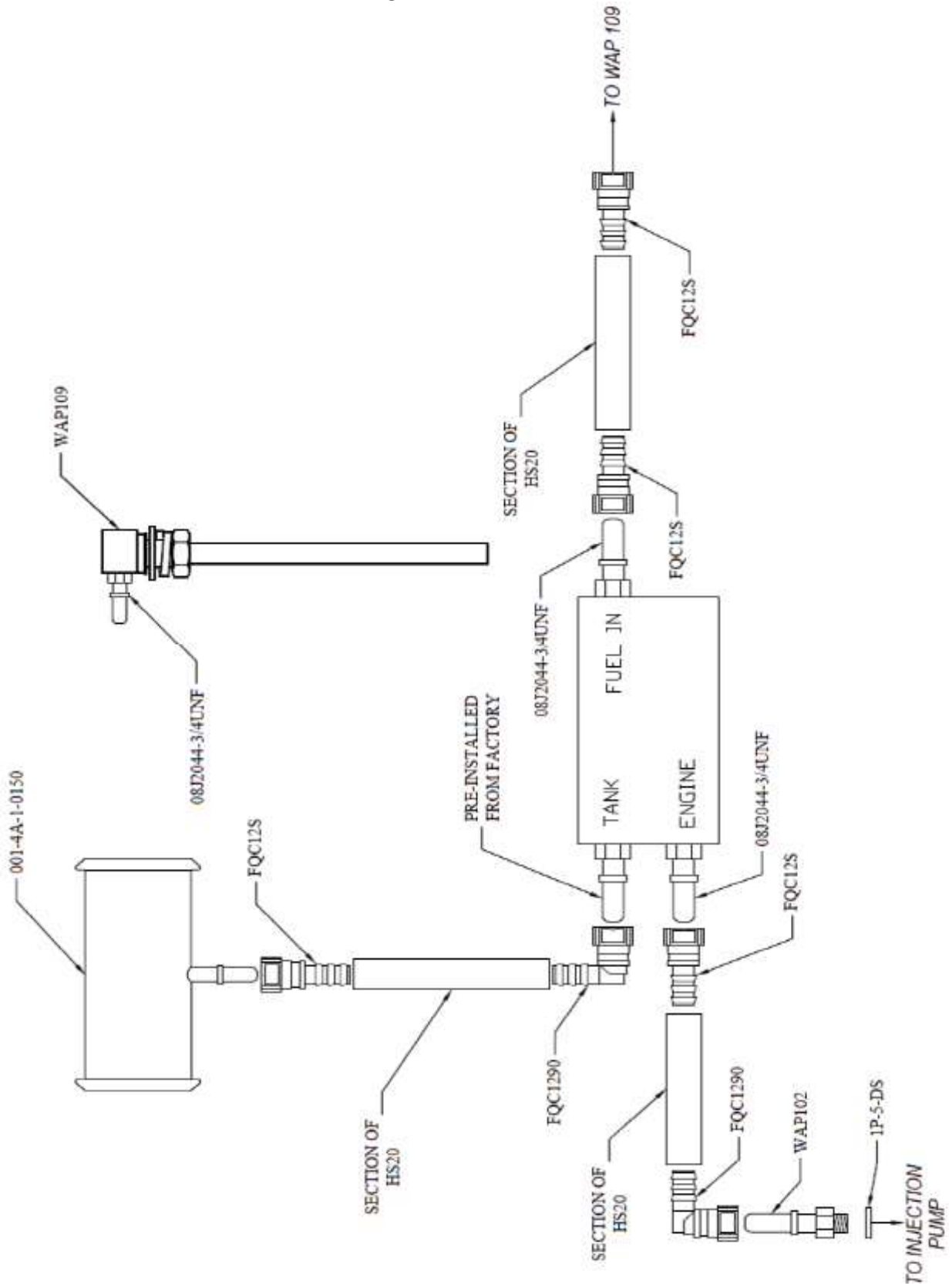

## Installing the AirDog® Pump Fittings

### Tools Needed:

- Torque Wrench
- 7/8" Deep Socket
- Clean Motor Oil or ATF

### Parts Needed:

- 2x 08J2044-3/4UNF Fittings

7-1. Dip the threaded end of the 1/2" male J2044 quick connect x 3/4" UNF fittings (08J2044-3/4UNF) into clean motor oil and hand-thread into the "ENGINE" and "FUEL IN" ports in the AirDog®. Using a 7/8" deep socket, torque these fittings to 180in-lb or 15ft-lb.

**NOTICE**

DO NOT overtighten the fittings or damage may occur!



Figure 1

## TOOLS NEEDED:

- 3/16 Allen
- 7/16 Socket or Wrench

## PARTS NEEDED:

- 4x 1/4-20 x 1.25 Socket Head Cap Screws
- 4x 1/4" Lock Washers
- 4x 1/4-20 Nuts
- 001-3C-0004 Cradle Bracket

**INSTALL THE AirDog® ON THE CRADLE BRACKET**

- 8-1. First, take a look under the truck and pick a location where the pump and brackets will fit. Once the location is known, orient the pump in the cradle bracket with the suction line "FUEL IN" pointed towards the fuel tank.

**NOTICE**

**We do recommend mounting the system on the inside of the frame if possible.**

- 8-2. Using the above listed hardware, mount the AirDog® to the cradle bracket (001-3C-0004) in the desired orientation (inlet fitting facing the rear of the vehicle) using a 7/16 socket and 3/16 allen wrench.



**Figure 2**



**Figure 3**

**TOOLS NEEDED:**

- 3/16 Allen
- 1/2 Socket or Wrench

**PARTS NEEDED:**

- 4x 5/16-18 x 3.0" Flat Socket Head Cap Screws
- 4x 5/16" Lock Washers
- 4x 5/16-18 Nuts
- 010-3C-0001 Front Frame Sandwich Plate (Multiple Holes)
- 010-3C-0003-A-P Spacer Block

**INSTALL THE AirDog® ON THE BRACKET SYSTEM**

- 8-3. Mock the Front Frame Sandwich Plate (Multiple Holes) (010-3C-0001) on the frame and hold the pump assembly up to it. Be sure to choose a set of holes that tucks the pump up as far as possible without touching the bottom of the cab and use those holes to mount the pump in the next step.

**NOTICE**

**Make sure the pump wires do not contact the bottom of the cab! Pump Failure due to rubbed through/shorted wiring from improper installation is not covered under warranty!**



Figure 4

BRACKET  
TOPBRACKET  
BOTTOM

**THE PUMP IN THE PHOTO IS A 5G, BUT THE CONCEPT IS THE SAME**

- 8-4. Assemble the AirDog mounting bracket (001-3C-0004) to the frame bracket (010-3C-0001) using the spacer (010-3C-0003-A-P) as shown in figure 5 using the four bolts, lock washers, and nuts included in the mounting bracket hardware kit (figure 6). Properly torque all fasteners! The bracket assembly should look like figure 7. You will need a 3/16" Allen and a 1/2" Wrench. The finished assembly should look like figure 8.



Figure 5



Figure 6



Figure 7



Figure 8

## Tools Needed:

- 2x 9/16" wrenches or socket wrenches

## Parts Needed:

- 3x 3/8-16 x 4.5" Hex Head Cap Screw
- 3x 3/8 Lock Washers
- 3x 3/8-16 Nuts
- 010-3C-0002 Back Frame Sandwich Plate

### INSTALL THE AirDog® ON THE TRUCK FRAMERAIL

- 9-1. Clamp the frame between the AirDog® bracket assembly and the back frame sandwich plate (010-3C-0002) using the 3/8" x 4.5" bolts, lock washers, and nuts included in the kit. Use two 9/16" wrenches to tighten. The two bolts go on top (Figure 9) and the single bolt goes on the bottom (Figure 10).

#### NOTICE

**DO NOT overtighten the bolts or you may bend the brackets and chip the powdercoat! Only tighten until the lock washers are flat.**

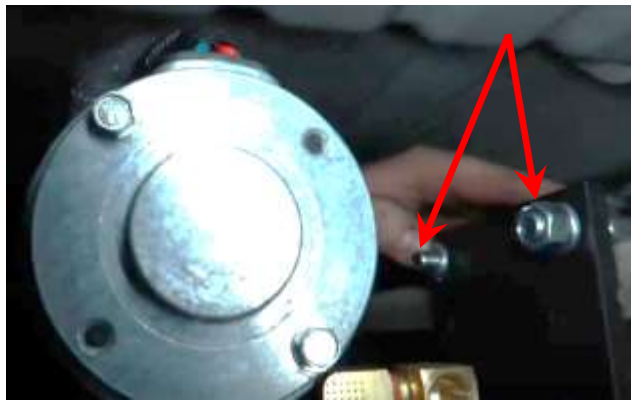

Figure 9

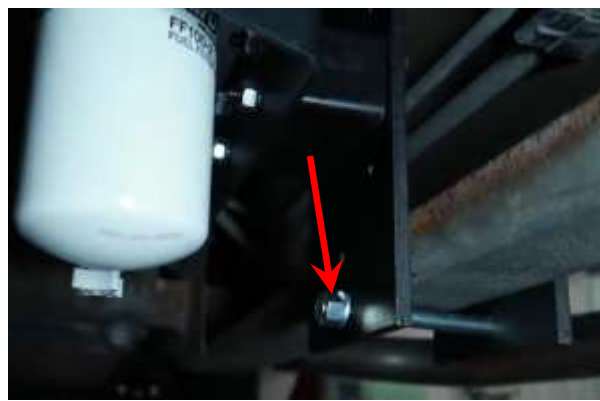

Figure 10



Figure 11



Figure 12

## Fuel Line Assembly Overview

This kit includes a length of fuel line and separate fuel line ends to allow for much cleaner looking installations! Assemble the fuel lines as you install them per the instructions later in this manual. This section is for explanation purposes.

### NOTICE

Do not pre-assemble the fuel lines or the lengths will not be correct!

- 10-1. Take the fuel line end and lubricate the barbed end with clean motor oil (Figure 13) and press it into the fuel line (HS20) until all of the barbs are covered (Figures 14 and 15). The fuel line end should look like Figure 15.



Figure 13



Figure 14



Figure 15

- 10-2. Now plug that fuel line with that fitting into the connection on the either the AirDog® or the truck where the manual calls it out.
- 10-3. Run the fuel line along the frame away from any hot or moving parts such as exhaust or the driveshaft (Figure 16). Cut the hose to length and insert the other fuel line end that the manual calls out into the fuel line as outlined in step 10-1.



Figure 16

### NOTICE

Hose clamps are not needed for these push-lock connections! They may cause damage to the hose and cause leaks. Damage due to hose clamps is not covered under warranty!

## TOOLS NEEDED:

- 13/16" Wrench or Extra Deep Socket
- Clean Motor Oil or ATF
- Hose Cutters or a way to cut Fuel Line
- 17mm Wrench

## PARTS NEEDED:

- WAP102 Injection Pump Fitting
- 1P-5-DS Sealing Washer
- FQC12S 1/2" Straight Quick Connect Fitting
- HS20 20ft Fuel Line

## Installing the Fuel Supply Line from the AirDog® to the CP3 Injection Pump 6.7L

### NOTICE

When installing the AirDog® fuel system, it is recommended to bypass the factory filter canister for optimum engine performance.

- 11a-1. Using a 17mm wrench, remove the "banjo bolt" (Highlighted in Figure 17) and the original factory fuel supply line at the fuel inlet port of the CP3 high pressure pump.

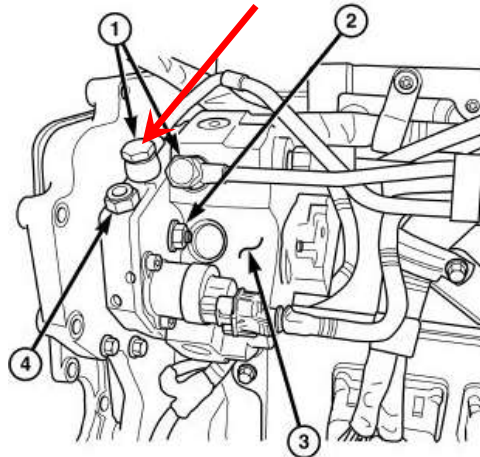

Figure 17

- 11a-2. Install the 12mm x 1/2" male SAE J2044 (WAP 102) fitting with the seal washer (1P-5-DS) supplied into the inlet port of the injector pump (Figure 18) using a 13/16" wrench. Do not over tighten the fitting. It may crack or break. Either Remove or bend the original supply line out of the way.

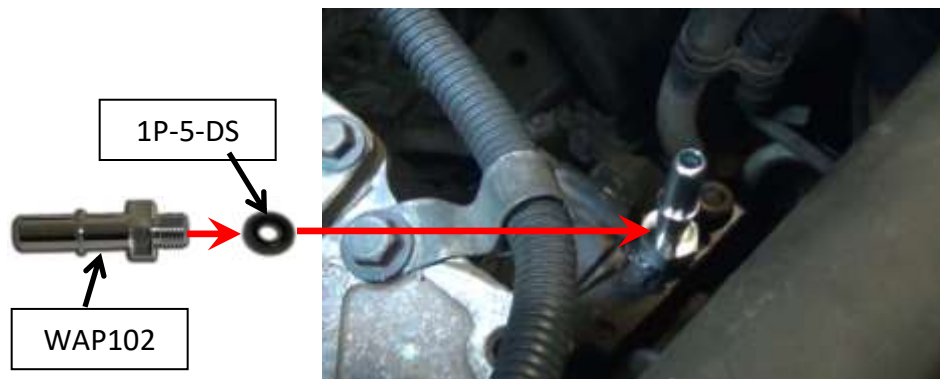
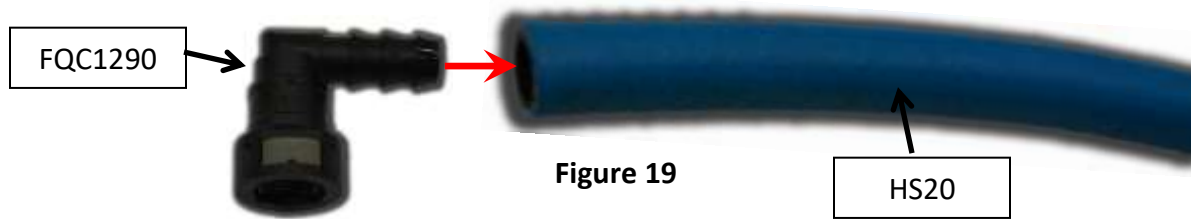

Figure 18

11a-3 Assemble one end of the hose (Reference section 10) using Fuel line end FQC1290 and plug it into the WAP102 fitting installed in the previous step. A “click” will be heard once the fitting is properly connected.



11a-4. Run the fuel line along the frame as mentioned in step 10-3 to the “Engine” port in the AirDog®. Cut the fuel line to length and insert fuel line end FQC12S per step 10-1. Once the connector is installed, connect it to the male J2044 fitting in the “Engine” port in the AirDog®. A “click” will be heard once properly connected.



11a-5. It is advised to remove the factory supply lines between the tank and the filter canister. Also remove the factory supply line between the filter canister and the injection pump. Then plug the ports on the filter canister. This will prevent fuel spillage. If it is desired to delete the fuel filter housing, you will need to purchase a fuel filter delete separately.

## TOOLS NEEDED:

- 13/16" Wrench or Extra Deep Socket
- Clean Motor Oil or ATF
- Hose Cutters or a way to cut Fuel Line
- 17mm Wrench

## PARTS NEEDED:

- WAP102 Injection Pump Fitting
- 1P-5-DS Sealing Washer
- FQC12S 1/2" Straight Quick Connect Fitting
- HS20 20ft Fuel Line

## Installing the Fuel Supply Line from the AirDog® to the CP3 Injection Pump 6.7L

### NOTICE

When installing the AirDog® fuel system, it is recommended to bypass the factory filter canister for optimum engine performance.

11b-1. Using a 17mm wrench, remove the quick connect fitting (Highlighted "2" in Figure 21) and the original factory fuel supply line at the fuel inlet port of the CP3 injection pump.

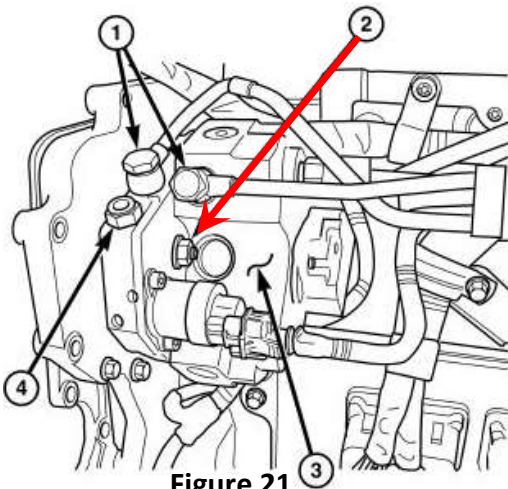

Figure 21



Figure 22

11b-2. Install the 12mm x 1/2" male SAE J2044 (WAP 102) fitting with the seal washer (1P-5-DS) supplied into the inlet port of the CP3 (Figure 23) using a 13/16" wrench. Do not over tighten the fitting. It may crack or break. Either remove or bend the original supply line out of the way.

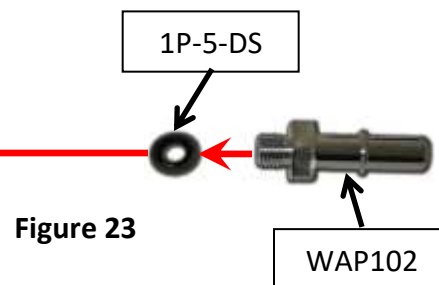

Figure 23

11b-3. Refer to steps 11a-3 and 11a-5 to install the fuel supply line for the 6.7L CP3.

TOOLS NEEDED:

- Clean Motor Oil or ATF
- Hose Cutters or a way to cut Fuel Line and the Filler Neck

PARTS NEEDED:

- 001-4A-1-0150 1.5" Filler Neck Return Tee with Clamps
- FQC1290 1/2" 90deg Quick Connect Fitting
- FQC12S 1/2" Straight Quick Connect Fitting
- HS20 20ft Fuel Line

## AirDog® Fuel Return Line

### Installing the fuel 'Return to Tank' assembly in Filler Tube

- 12-1. Cut filler tube as illustrated in figure 24, removing 1/2 inch of hose. Loose assemble the clamps on each end of filler tube before the filler tube is pushed in.
- 12-2. Insert the "Return Fuel Filler Tube" assembly (P/N 001-4A-1-0150) in the filler tube. **INSTALL THE FILLER TUBE WITH ARROWS, WHICH ARE STAMPED IN THE PART, POINTING TOWARD THE TANK!! SEE FIG 25.** Properly tighten clamps.

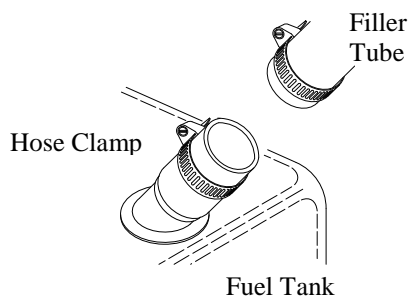

**Figure 24**

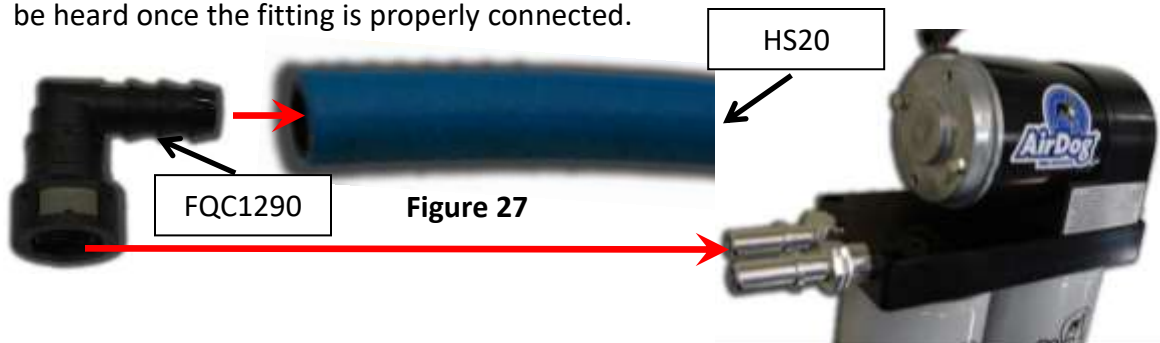

**Figure 25**



**Figure 26**

- 12-3. Assemble one end of the hose (Reference section 5) using Fuel line end FQC1290 and plug it into the "Return" J2044 fitting installed in the AirDog® (Figure 27). A "click" will be heard once the fitting is properly connected.



**Figure 27**

- 12-4. Run the fuel line along the frame as mentioned in step 10-3 to the filler neck tee. Cut the fuel line to length and insert fuel line end FQC12S per step 10-1. Once the connector is installed, connect it to the male J2044 fitting in the filler neck tee (001-4A-1-0150). A "click" will be heard once properly connected.



**Figure 28**

## Section 13

## Fuel Suction Line (From the Fuel Tank to the AirDog® Inlet)

## TOOLS NEEDED:

- Clean Motor Oil or ATF
- Hose Cutters or a way to cut Fuel Line
- 1" Hole Saw or Step Bit that can go up to 1"
- Hammer
- Large Screwdriver
- 7/8" Wrench or Deep Socket
- Tape Measure
- Permanent Marker
- Small Pilot Drill Bit
- 1/2" Drill Bit
- Cut-Off Wheel or Saw
- 1.5" Wrench or Adjustable Wrench

## PARTS NEEDED:

- 2x FQC12S 1/2" Straight Quick Connect Fitting
- WAP109 High Flow Suction Tube
- HS20 20ft Fuel Line
- 08J2044-3/4UNF

## Fuel Suction Line From the Fuel Tank to the AirDog® "INLET" Port

### NOTICE

This fuel pump **REQUIRES** the installation of this high flow suction tube or aftermarket sump! Failure to do so **WILL** cause pump failure and may void your warranty!

- 13-1. Assemble one end of the suction fuel line (reference section 10) using fuel line end FQC12S. Once the end is pressed in, connect it to the J2044 fitting in the "Fuel In" port on the AirDog®. A "click" will be heard when the fitting is properly connected.



**Figure 29**

## HIGH FLOW SUCTION TUBE

- 13-2. To install the WAP109, you will need to either drop the fuel tank or remove the truck bed.

### NOTICE

Should you choose to drop the fuel tank, support the tank as it is when it is installed on the truck. If you let it rest flat on the floor, the tank may squash out and the suction tube will be too short after the tank is re-installed in the truck. The suction tube, being cut too short may suck air as the fuel drops below 1/4 tank level.



**WARNING:** Failure to use proper jack stands while working under a vehicle may result in **SERIOUS INJURY OR DEATH!**



**CAUTION:** Failure to properly support the fuel tank upon removal/installation, may result in **INJURY!**

### When Dropping the Tank, Always Remember, Safety First!

- 13-3. When dropping the tank, be sure to disconnect any attached fuel lines, sender wires, and fuel filler necks.



Figure 30



Figure 31



Figure 32

**NOTICE**

Should you choose to pull the pickup bed to access the tank. Be sure to disconnect the tail light wires, fuel tank filler tube, and any other accessories or components that may be secured to the frame and bed.

 **WARNING:** Failure to use proper jack stands while working under a vehicle may result in **SERIOUS INJURY OR DEATH!**

 **WARNING:** Failure to properly secure the bed while being removed/installed, may result in **SERIOUS INJURY OR DEATH!**



Figure 33



Figure 34

**NOTICE**

The fuel tank and truck bed used for the pictures are examples only and may not be exactly the same as your tank.

**NOTICE**

**IMPORTANT:** Select a location for the suction tube that has adequate clearance below the bed. Also consider that under hard acceleration, fuel will migrate toward the back of the fuel tank.

13-4. Once either the tank has been dropped or the bed removed, remove the collection basket as shown in figures 35 and 36.



Figure 35



Figure 36

- 13-5. Select a spot to install the WAP109 draw straw. Be sure no bed supports or any cross members will contact the bulkhead fitting once the bed or tank is reinstalled. Drill a 1" hole using a step bit in your selected location (Figure 37). Hold a container below the drill point to catch debris as shown in figure 38.



Figure 37



Figure 38

- 13-6. Remove all burrs from the edge of the hole as shown in figure 39.



Figure 39

- 13-7. Install fitting 08J2044-3/4UNF into the bulkhead fitting of the WAP109 draw straw, as shown, using a 3/4 wrench. Tighten until the O-ring is no longer visible.

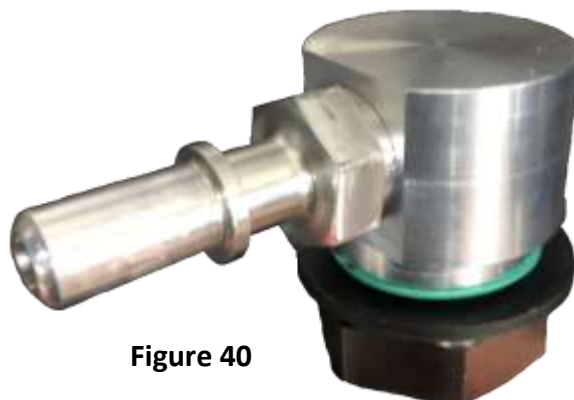

Figure 40

- 13-8. Mock the suction tube in the fuel tank and measure from the top of the fuel tank to the bottom of the green seal (Figure 41). Take this measurement and subtract a 1/4 inch. Measure from the bottom of the tube and mark the previous measurement as shown (Figure 42). The subtracted 1/4" will ensure the bottom of the straw is against the bottom of the tank once reinstalled.



Figure 41



Figure 42



- 13-9. Drill crossing pilot holes through the nylon tube, centered on the marked line, as shown (Figure 43). Use a larger bit (1/2" MAX) to open the holes up (Figure 44).

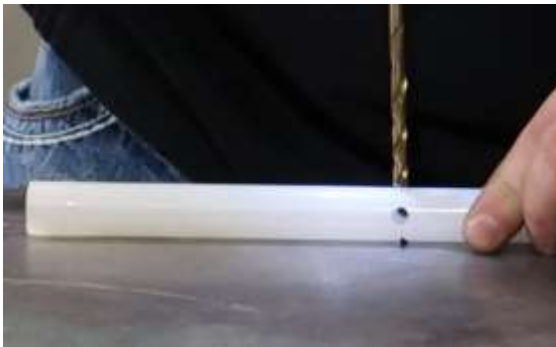

Figure 43



Figure 44

## Section 13 (Continued)

## Fuel Suction Line (From the Fuel Tank to the AirDog® Inlet)

13-10. Cut the fuel tube to the measured length (Figure 45). Deburr the tube (Figure 46) to be sure no debris get pulled into the fuel pump.



Figure 45



Figure 46

13-11. Install the trimmed WAP109 into the previously drilled hole in the tank and orient it in the desired direction (Figure 47). Make sure the bottom of the straw is contacting the bottom of the fuel tank. Install the hardware in this order: washer, lock washer, nut (Figure 48). Tighten the nut with a 1.5" wrench or adjustable wrench till snug (Figure 49). (Tank Cutaway is for reference. Access to straw is through module hole.)



Figure 47



Figure 48



Figure 49

13-12. Re-install the fuel module. Re-install the factory return line (The smaller of the two lines) to the proper port of the fuel module before the tank or bed is fully re-installed.

**NOTICE**

The factory engine return line **MUST** be reconnected to the fuel module!  
The factory engine feed port can be capped off with a vacuum cap.



Figure 50

- 13-13. Run the fuel line along the frame as mentioned in step 10-3 to Suction Tube (WAP109). Cut the fuel line to length and insert fuel line end FQC12S per step 10-1. Once the fuel line end is pressed in, press it onto the quick connect fitting in the WAP109. A “Click” will be heard once properly connected.



- 13-14. Since the factory suction line is no longer used, cap the factory suction line with the supplied vacuum cap (P/N HVC-467-16) and hose clamp (P/N 4C-2-1-10)



- 13-15. If the fuel tank was dropped to install the suction tube, re-install the fuel tank and make sure the factory fuel return line, fuel module wiring, and filler neck are reconnected. If the truck bed was removed, reinstall the bed and reconnect any ground wires, tail light wiring, and filler neck connections.

## AirDog® Wiring Harness Install

### WIRING DIAGRAM

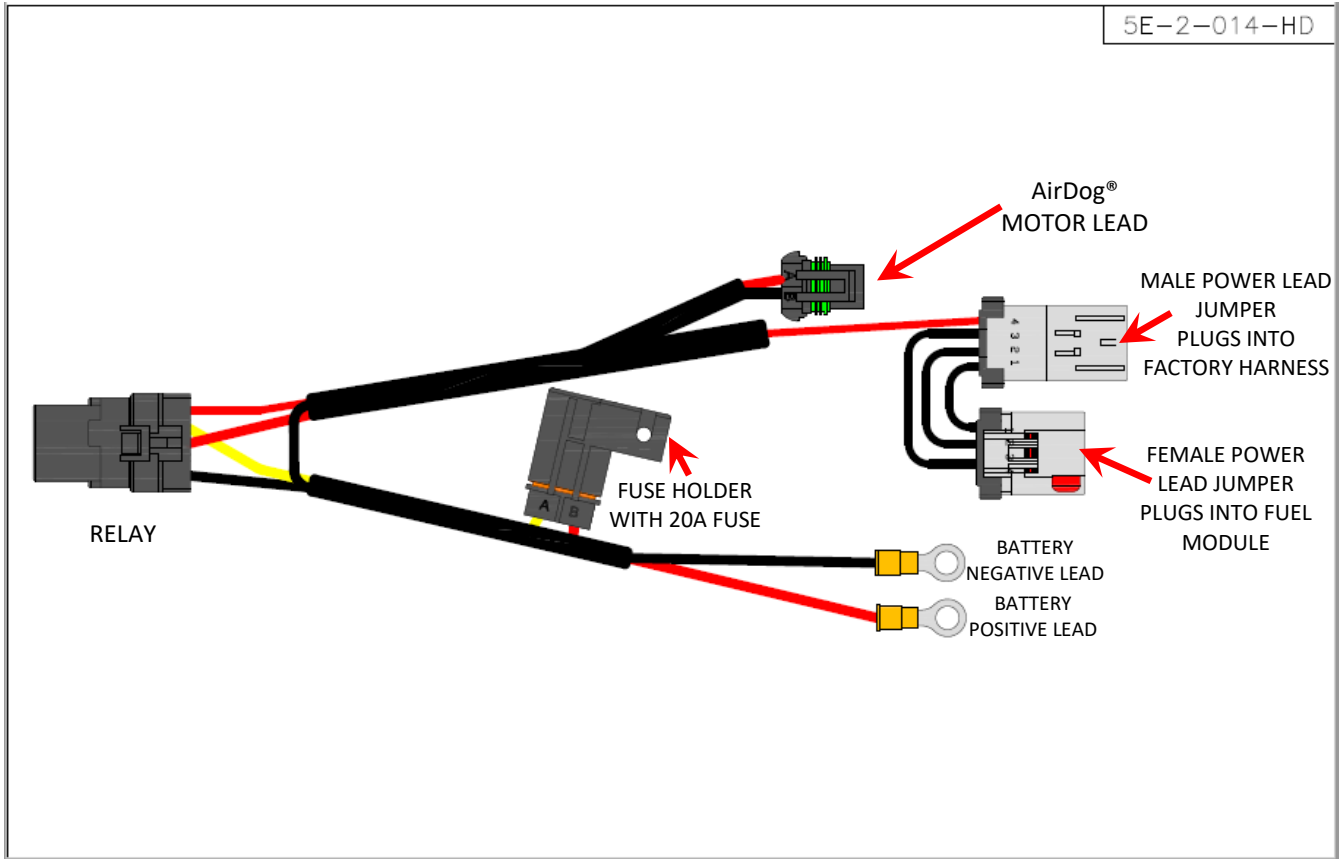

Figure 53

### Secure the Relay and Fuse Holder to the Vehicle

- 14-1. Secure the relay and fuse holder to the vehicle. Be sure to rout the wires away from any moving parts. The relay is illustrated below in figure 54. The fuse holder mounting is the same concept.



Figure 54

## Connecting the AirDog® Power Lead Jumpers

- 14-2. Remove the factory wire harness connection from the top of the fuel module as seen in (Figure 55)



Figure 55

- 14-3. Plug the AirDog® female power lead jumper into the top of the fuel module.  
 14-4. After a “click” is heard, slide the red locking clip over to lock the connection in place.  
 14-5. Plug the factory wire harness connector into the AirDog male power lead jumper. Again, listen for the “click”.

## Connecting the Power Supply Leads to the Alternator or Battery

### NOTICE

Connecting the power supply leads to the alternator instead of the battery will create a corrosion resistant connection.

- 14-6A. Route the Red and Black power supply leads to the alternator. Connect the Black (-) lead to the alternator Chassis Ground connection. Connect the Red (+) lead to the alternator Hot Lead going to the battery.

Black (-)

Red (+)

Replace the Protective Cover



Figure 56



Figure 57

## Connecting the power supply leads Continued

14-6B. Should you choose to connect the power supply leads directly to the battery, connect the Red (+) led to the Positive (+) post of the driver's side battery. Connect the Black (-) lead to the Negative (-) post of the same battery.

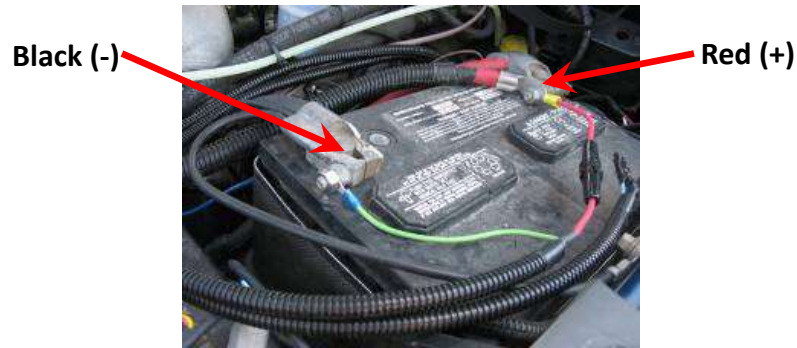

Figure 58

14-7. Route the wiring harness to the AirDog® and connect the 2 pin Deutsch connector to the corresponding connector on the AirDog®.

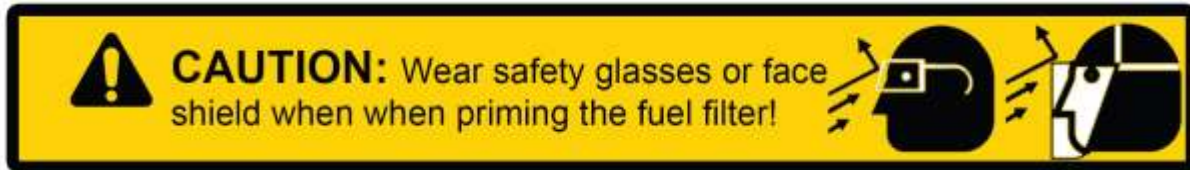

Figure 59

## INITIAL START PROCEDURE

The AirDog® is a self-priming system, however, to prevent potential damage to the system, it is recommended to fill the pre-filter with diesel fuel before initial startup.

- 15-1. Fill the water separator with diesel fuel.
- 15-2. Turn the starter key to the on/run position.
- 15-3. While the AirDog® is operating, bleed the air from the fuel line to the engine by loosening the fuel line connection at the engine fitting. As soon as the line is purged of air and pure fuel is observed, properly tighten the fuel fitting.



**NOTE:** put a rag or shop towel over and around fitting to prevent splatter. Catch all spilled fuel and dispose of properly.

- 15-4. Start the engine!

**RECHECK ALL FUEL FITTINGS FOR LEAKAGE AND PROPERLY TORQUE. BE SURE ALL FUEL LINES ARE PROPERLY ROUTED TO PROTECT FROM EXCESSIVE HEAT AND SECURED TO PROTECT FROM CHAFFING AND ABRASION. RECHECK ALL ELECTRICAL LINES, SECURE AS NECESSARY.**

### Checking Pump Noise!

**NOTE:** Each AirDog® has been manufactured in a Quality Controlled process and fully tested for operation and performance before shipment. This is a smooth running system. However, if any fuel fitting on the vacuum side, between the fuel tank and the AirDog® or the pre-filter, has been left loose during the installation process, the system may suck air at an excessive rate and will be very noisy. To check for this problem, unscrew the pre-filter 3 or 4 full turns and activate the AirDog® by turning the ignition switch to on. If the AirDog® runs quietly, then excessive air from a loose fitting or leaking pre-filter seal is most likely the reason for the excessive noise. Correct as necessary.

- A. The seal groove in the pre-filter is a snug fit and on occasion the seal has been found to not be fully seated. Remove the pre-filter, remove the seal from the top of the nut plate. Clean and lubricate the seal groove. Carefully replace the seal in the groove. Be sure to fully seat the seal.
- B. Check the fittings, especially the quick connect at the tank.

## Filter Service Recommendations

Plugging of either the fuel filter or the water separator itself will cause low fuel pressure and low flow to the engine. If a low fuel pressure issue exists, replace the fuel filter. Typical fuel filter life is 15-20k miles depending on fuel quality.



### The Water Separator

Replace the water separator every other time you change the Fuel Filter or if it becomes damaged or plugged. It is suggested to check/drain the water separator every three months or as needed should you experience excessive 'water in fuel' conditions. When installing the water separator, be sure to clean the underside of the AirDog® base. Follow the instructions printed on the pre-filter for proper tightening procedures.

**NOTE:** Be extremely careful to prevent any contaminants or debris from entering the pre-filter when removing it for cleaning! Large debris will jam the Gerotor and cause the fuse to blow. This is not a warranty item. Should this happen, you can easily put the system back into working order. See the instructions on "How to clean the Gerotor" for proper procedures.

### The Fuel Filter

Remove the fuel filter by turning it counter clockwise. Do not pre-fill the fuel filter with fuel. The AirDog® will fill the filter and prime the system automatically. Follow the instructions on the filter for proper tightening procedures.

**NOTE:** Dispose of waste fuel and used filters properly to protect OUR environment!

## Changing the Regulator Spring

**The AirDog® is shipped from the factory with the fuel pressure preset.**

For the 2004.5-2024 Dodge Cummins the AirDog® fuel outlet pressure is preset at 15 PSI ( $\pm 2$ ). However, for some applications, you may desire to increase the pressure output from your AirDog®. To do this, you will need to install a higher tension spring.

### Regulator Spring Replacement Procedure



**The regulator spring and ball assembly is located inside the Return to Tank fuel port.**

Step-1. Disconnect the 'Return to Tank' fuel line.



**Figure 60**

Step-2. Remove the 'Return to Tank' fuel line fitting exposing the regulator spring.

Step-3. Remove the ball and spring.



**Figure 61**



**Figure 62**



**Figure 63**

Step-4. Install the new regulator spring by reversing the steps 1 thru 4. Be sure to place the regulator ball in the regulator seat before inserting the spring. Properly torque the return line fitting and swivel connection when finishing.

**CLEANING DEBRIS/CHECKING FOR DAMAGE IN/TO THE GEROTOR ASSEMBLY**

**STEP 1:** Remove the four (4) socket head cap screws that secure the Gerotor cap using a 3/16 allen wrench.



**STEP 2:** Carefully remove the O-rings you will need to reuse them.



**STEP 3:** Remove and clean the Gerotor. Be very careful to not damage the Gerotor.

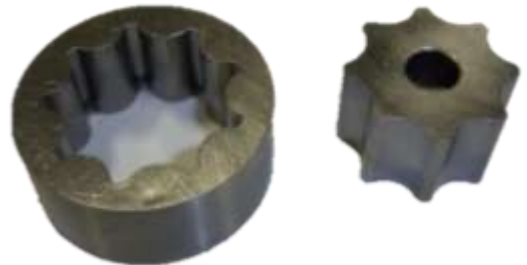

**STEP 4:** Remove the O-rings and clean/inspect the inside of the Gerotor pocket.



**STEP 5:** Reinstall the center gear.



**STEP 6:** Align and install the outer gear and O-rings.



**STEP 7:** Install the Gerotor Cap. Be very careful not to dislodge or pinch the O-rings.



**STEP 8:** Loose assemble the cap screws. Torque the cap screws in an opposing pattern.

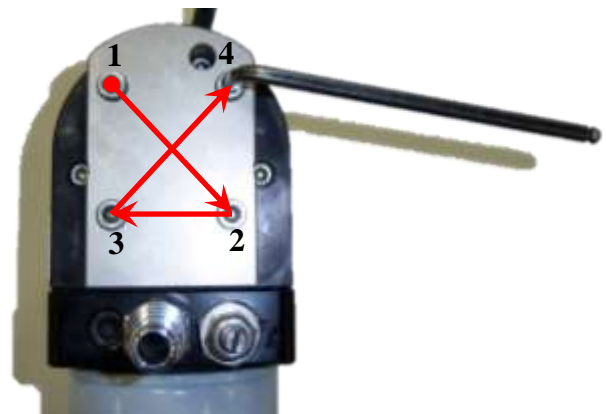

If there is damaged found to either the Gerotor, Gerotor pocket, or O-rings, call into AirDog® Tech Support for further assistance.

PUREFLOW AIRDOG  
***LIFETIME LIMITED EXPRESS WARRANTY***

FOR

Covered PureFlow AirDog I, II and Raptor Systems

**IMPORTANT NOTICE**

**TO ACTIVATE YOUR PUREFLOW AIRDOG WARRANTY, YOU MUST COMPLETE AND MAIL YOUR WARRANTY CARD TO PUREFLOW AIRDOG WITH A COPY OF YOUR ORIGINAL SALES RECEIPT WITHIN 30 DAYS OF PURCHASE. FAILURE TO COMPLETE AND SUBMIT YOUR WARRANTY CARD WILL RESULT IN A WARRANTY PERIOD OF THE COVERED PRODUCE TO ONE (1) YEAR FROM THE DATE OF PURCHASE.**

PureFlow AirDog (hereafter collectively, "SELLER") warrants and guarantees only to the Original Purchaser (hereafter collectively, BUYER) that All PureFlow AirDog Filtered Systems (hereafter collectively, PRODUCT) shall be free from defects of materials and workmanship in the manufacturing process for as long as the BUYER owns the PRODUCT.

The Lifetime Limited Express Warranty is limited to the PRODUCT purchased by the original BUYER of the PRODUCT and limited solely to the parts contained within the PRODUCT and EXCLUDES ALL ELSE INCLUDING FILTERS AND WATER SEPARATORS. Any PRODUCT that is in question of Warranty must be returned, shipped prepaid, to PureFlow AirDog. All Warranty claims are subject to the approval of PureFlow AirDog. If it is determined that a Warranty claim exists, PureFlow AirDog will, at its sole discretion, replace the defective PRODUCT with a comparable PRODUCT, repair the defective PRODUCT, or refund the BUYER'S purchase price in exchange for the PRODUCT. Repairs or replacements are warranted for only the remainder of the original warranty period and only to the original BUYER.

Under no circumstances shall the SELLER be liable for any labor charged or travel time incurred in the diagnosis for defects, removal, or reinstallation of the PRODUCT, or any contingent expense.

Under no circumstances will the SELLER be liable for any damage or expense incurred by reason of the use or sale of the PRODUCT.

Other than expressly set forth herein, the SELLER shall in no way be responsible for the proper or improper use and service of the PRODUCT. In no event shall the SELLER be liable for any special, incidental, indirect or consequential damages of any kind or nature, whether or not the BUYER of the PRODUCT was advised of the possibility of damage or harm, arising or resulting from the use or performance of the PRODUCT and BUYER hereby waives the right to any and all such claims.

BUYER, acknowledges that he/she is not relying on SELLER'S skill or judgment to select or furnish goods suitable for any particular purpose and that SELLER has no liability that will extend beyond the scope of the LIMITED EXPRESS WARRANTY contained herein, and BUYER hereby waives all remedies or liabilities, expressed or implied, arising by operation of law or otherwise (including, without limitation, any obligation of SELLER with respect to fitness for any particular purpose; merchantability; and special, incidental, indirect or consequential damages) or whether or not occasioned by SELLER'S negligence.

SELLER disclaims any warranty and expressly disclaims any liability for personal injury or damages related to BUYER'S use of the PRODUCT. BUYER acknowledges and agrees that the disclaimer of any liability for personal injury is a material term for this agreement and BUYER agrees to indemnify SELLER and hold SELLER harmless from any claim related to the PRODUCT and its use or performance. Under no circumstances will SELLER be liable for any damages, liabilities, costs or expenses incurred as a result of or by reason of use, performance or sale of the PRODUCT, including without limitation, any damages, liabilities, costs or expenses incurred by reason of BUYER'S negligence related to those uses of the PRODUCT.

The proper installation of the PRODUCT is the sole responsibility of the BUYER. The SELLER assumes no liability regarding improper installation or misapplication of the PRODUCT.

## Section 19 (Continued)

## Warranty

SELLER hereby provides the following limited warranty as to description, quality, merchantability, fitness for the PRODUCT'S purpose, productiveness, or any other matter of SELLER'S PRODUCT sold herewith. The SELLER shall be in no way responsible for the open use and service of the PRODUCT and the BUYER hereby waives all rights other than those expressly written herein. This Warranty shall not be extended or varied except by a written instrument signed by SELLER and BUYER.

IN THE EVENT THAT THE BUYER DOES NOT AGREE WITH THIS AGREEMENT, THE BUYER MAY PROMPTLY RETURN THE PRODUCT, IN A NEW AND UNUSED CONDITION, WITH A DATED PROOF OF PURCHASE, TO THE PLACE OF PURCHASE WITHIN THIRTY (30) DAYS FROM THE DATE OF PURCHASE FOR A FULL REFUND. THE BUYER AGREES THAT THE INSTALLATION OF THIS PRODUCT CONFIRMS THE BUYER HAS READ AND UNDERSTANDS THIS AGREEMENT AND ACCEPTS THE TERMS AND CONDITIONS OF THIS AGREEMENT.

## Warranty Procedure

In the unlikely event a warranty appears as if it may be warranted, the following steps are taken:

- 1 The customer discussed the symptoms of the problem with a PureFlow AirDog Technician. The customer is to have the system Serial Number and Model Number available for the Technician when the call is made. This will expedite all steps of the process.
- 2 The customer performs any and all tests requested by the PureFlow AirDog Technician. This is done to isolate the potential problem while eliminating potential installation or maintenance related issues,
- 3 If the PureFlow AirDog Technician determines based on the customer feedback concerning the requested testing that system may be at fault, the customer is advised that all returned pumps are tested upon arrival and should this returned pump perform at design criteria upon arrival, the customer will be charged a \$50.00 fee.
- 4 The PureFlow AirDog Technician will first request the customer's phone number in the event the phone call is accidentally disconnected and then transfer the customer to a PureFlow AirDog Customer Service Representative. Should a Customer Service Representative not be available, the Technician will offer the Customer the option to hold, call back, or receive a return call.
- 5 The PureFlow AirDog Customer Service Representative will check to determine if the customer's Warranty Registration Card is on file.
  - a. If no Warranty Registration is found, the customer will be required to supply the original purchase receipt showing the purchase date.
  - b. If no Warranty Registration is found, the customer will be advised of the options should the system in question is out of the default warranty period (1 year).
- 6 The PureFlow AirDog Customer Service Representative will request the customer information, including: Name, Address, Phone Number, Model Number, Serial Number, Year / Make / Model of vehicle, Name of Dealer purchased from, Purchase Date, Description of Problem, Customers' understanding of the resolution, and customer credit card information.
- 7 PureFlow AirDog will cover Ground Shipping charges to ship the replacement unit and will include a prepaid shipping label for the return of the defective unit. Any additional items ordered at the time of the replacement shipment will include their portion of the shipping cost.
- 8 A period of 15 Calendar Days from the time of shipment is provided for the receipt of the defective unit at the PureFlow AirDog facility. Failure to return ship the defective unit to arrive within the defined time period will result in a charge of \$250.00 against the customer's credit card as the purchase cost of the defective unit.

**Revised: August 14, 2025**