

#61

AirDog® II-5G DF-165

2017-2022 6.7L POWERSTROKE INSTALLATION MANUAL

**PLEASE READ THIS MANUAL AND CHECK
CONTENTS OF THE KIT BEFORE
BEGINNING THE INSTALLATION**



**PUREFLOW AIRDOG
705 W MAUSOLEUM RD.
SHELBYVILLE, IN 46176**

**877-421-3187
PUREFLOWAIRDOG.COM**

AirDog® II-5G



SMALL and COMPACT

7" Long X 3.2" Wide X 10" Tall

OVERVIEW

Thank you for your purchase and welcome to PureFlow AirDog's AirDog®II-5G fuel air separation and delivery system for the 2017-2022 6.7L Powerstroke.

The AirDog®II-5G is an all in one premium fuel pump and filtration system for the 6.7L. This system removes water, particulates, and entrained air from the diesel fuel. The entrained air that is separated from the fuel is returned to the tank through a small return fitting. The fuel is delivered to the engine at the correct pressure and flow rate to meet the demands of the engine under all operating conditions.

The AirDog®II-5G DF-165 systems feature a built in adjustable diaphragm pressure regulator. All AirDog®II-5G systems include a complete installation kit.

The AirDog®II-5G, for this particular application, is preset at 60psi at idle and 70psi under load from factory for a stock application. The regulator is adjustable up to 75 psi for fine tuning the system for performance upgrades. **WARNING: RUNNING THE PUMP ABOVE 75PSI WILL DECREASE THE LIFE OF THE PUMP SIGNIFICANTLY AND MAY VOID THE WARRANTY.**

PureFlow AirDog products are manufactured in Shelbyville Indiana by a team of skilled workers with unsurpassed attention to detail and using the most stringent quality assurance.

HOW THE 5G OPERATES

The AirDog®II-5G DF-165 draws fuel from the fuel tank. The fuel is then drawn through the water separator where 92% of water is removed per SAE spec 1488. It is then pressurized through a Gerotor pump and sent to the 2 micron fuel filter before it is sent to the injection pump. The air from aerated fuel, due to tank sloshing and engine return lines, is separated and sent back to the tank through the 3/8" return fitting. The excess fuel that the engine does not use is recirculated through the diaphragm regulator back to the suction side of the pump.

For this particular application, part of the pressureized fuel is sent back to the modified fuel module to allow the venturi basket fill action to work as intended from the factory. This will ensure there will be no loss of fuel suction until the fuel tank is completely empty.

WHY WE USE QUICK CONNECT FITTINGS

Almost every modern vehicle on the road uses what are called quick connect fittings for their fuel system. These are standardized using J2044 SAE specifications. We use these fittings to make the installation of our fuel systems as simple and as least invasive as possible. This allows for a simple/clean installation of our products.

HOW THE CONNECTIONS WORK

To connect the assemblies, simply insert the male end form into the mating female connector. Push firmly until you hear it “click” into place. To disconnect the fittings, press down and hold the tabs on the female connector while you firmly pull the assembly apart.



TABLE OF CONTENTS

Section 1.....Table of Contents
 Section 2.....Installation and Safety Guidelines
 Section 3.....Parts List

SYSTEM LAYOUT

Section 4.....System Layout Short Bed
 Section 5.....System Layout Long Bed

PRE-INSTALLATION PROCEDURES

Section 6.....Dropping the Fuel Tank
 Section 7.....Removing and Modifying the Fuel Module

INSTALLATION PROCEDURES

Section 8.....Installing the AirDog on the Bracket
 Section 9.....Installing the Pump Fittings
 Section 10.....Installing the Pump on the Truck

FUEL LINES

Section 11.....Fuel Line Assembly
 Section 12.....Hooking up the Factory Return Line
 Section 13.....AirDog Suction Line
 Section 14.....AirDog Return Line
 Section 15.....Engine Feed and Venturi Feed Lines

ELECTRICAL HARNESS

Section 16.....Wiring Harness

POST-INSTALLATION PROCEDURES

Section 17.....Reinstall the Fuel Tank
 Section 18.....Starting Procedures

MAINTNANCE AND WARRANTY

Section 19.....Filter Maintenance
 Section 20.....Cleaning and Inspecting the Gerotor
 Section 21.....Adjusting the Fuel Pressure
 Section 22.....Warranty Procedure

AirDog® II-5G MODEL DF-165 INSTALLATION GUIDELINES

The installation of your AirDog® II-5G can be relatively easy by following the steps outlined in this manual, and:

1. Inventory the package components completely. Notify *PUREFLOW AIRDOG* immediately of any missing or damaged parts. (877-421-3187)
2. Read the installation manual completely. Understand how the system operates and take note of installation recommendations before beginning installation.
3. The installation recommendations contained herein are suggested installation guidelines only. Individual installations may vary.
4. When installing the AirDog® II-5G fuel lines, be sure to connect the ORIGINAL ENGINE RETURN LINE to the fuel tank as it was from the factory when the installation is complete!



If any installation procedure is uncertain, contact
PUREFLOW AIRDOG for technical assistance.







SAFETY GUIDELINES!

- CAUTION!** Be sure to check the vehicle's tires to prevent rolling.
- CAUTION!** Use proper supports when working beneath an elevated vehicle.
- CAUTION!** Most diesel pickups have two (2) 12volt batteries. Disconnect the battery cables to both batteries before proceeding with the AirDog® II-5G installation.
- CAUTION!** Vehicle frame rails should not be drilled into or welded upon.
- CAUTION!** Wear safety glasses when operating power tools such as drills and grinders or when using a punch or chisel.
- CAUTION!** Use common sense when routing fuel lines and electrical harnesses. Keep them away from hot exhaust components and/or moving parts. Properly secure lines to prevent chaffing.

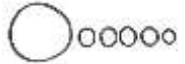
NOTE: The pictures used in this manual are for example only and may not be exactly the same as your truck.

6.7L PowerStroke Parts List

QTY	DESCRIPTION	PART NUMBER	IMAGE
1	AirDog® II-5G	DF-165	
1	AirDog® II-5G Mounting Bracket	001-3C-0004	
1	17-21 Ford Bed Bracket	010-3C-0005-F	
1	Mounting Hardware Kit,	901-61-0102-PM-C-12	
1	Wiring Harness	5E-2-020	
1	Bundle of Plastic Ties	5H-2-1-06/12	
6	Smaller Hose Clamps	4C-2-1-12	
2	Larger Hose Clamps	4C-2-1-14	
1	20ft of Fuel Line	HS20	
1	3/8" Fuel Line	HS3801	
1	5/16" Fuel Line	4C-1-02-05-001	
3	1/2" Straight Hose Quick Connect Fitting	FQC12S	
3	1/2" 90° Hose Quick Connect Fitting	FQC1290	
2	11.8mm 90° Hose Quick Connect Fitting (Has an external Brown O-ring)	FQC11890	
3	11.8mm Straight Hose Quick Connect Fitting (Has a red dot on the fitting)	FQC118S	
2	3/8" Straight Hose Quick Connect Fitting	FQC38S	
1	5/16" to 3/8" Barb Hose Adapter	4A-1-09-04-06-ST	

1	Customer Service O-ring Replacement Kit	901-05-0500	
2	1/2" Male J2004 Quick Connect x 3/4-16" UNF	08J2044-3/4UNF	
1	3/8" Male J2004 Quick Connect x 7/16" UNF	06J2044716UNF	
1	12mm to 12mm to 3/8in Return Tee	001-4B-1-0067	
1	12mm to 12mm Return Line Adapter	001-4B-1-0067-17	
1	EP24 Socket	EP24	

901-61-0102-PM-C-12 Bolt Kit List

QTY	DESCRIPTION	IMAGE
4	1/4-20 X 1.25 CAP SCREW	
4	1/4-20 NUT	
4	1/4" SPLIT LOCK WASHER	
4	5/16-18 X 0.75 CAP SCREW	
4	5/16-18 NUT	
4	5/16 SPLIT LOCK WASHER	

System Layout for a Short Bed

NOTE: FUEL MODULE NEEDS TO BE MODIFIED BEFORE THE FUEL LINES CAN BE HOOKED UP

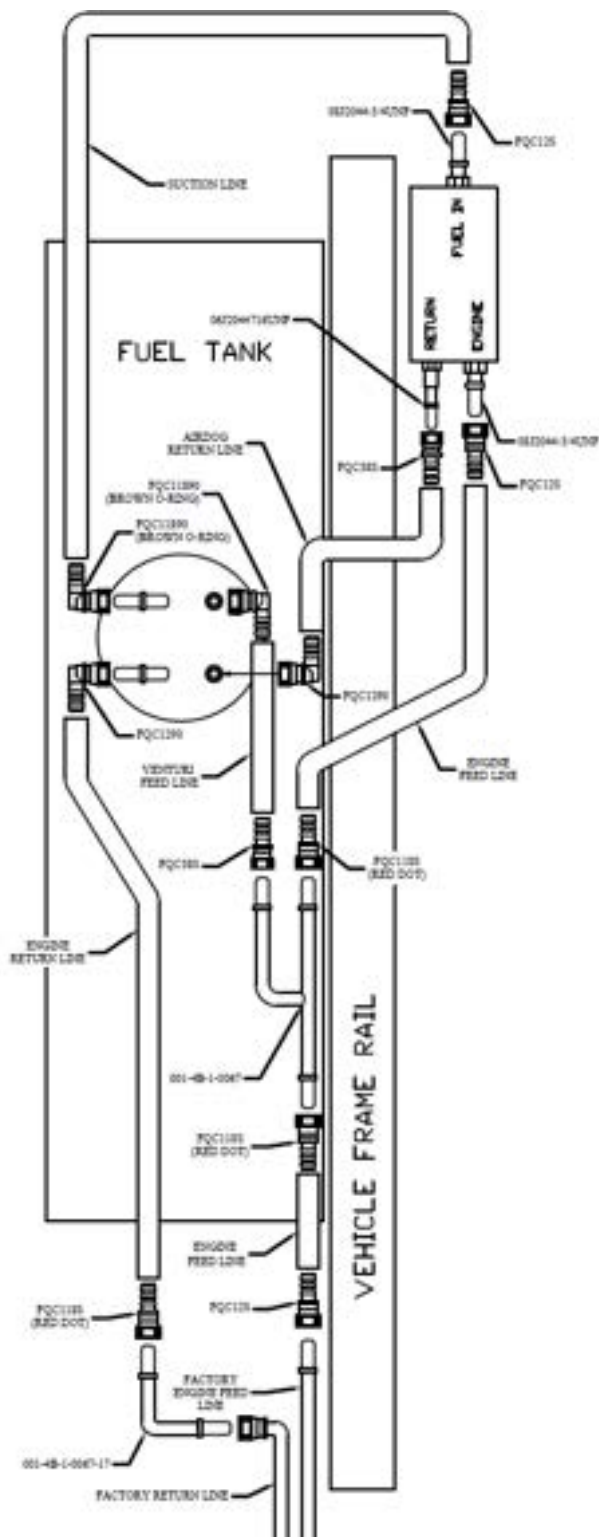
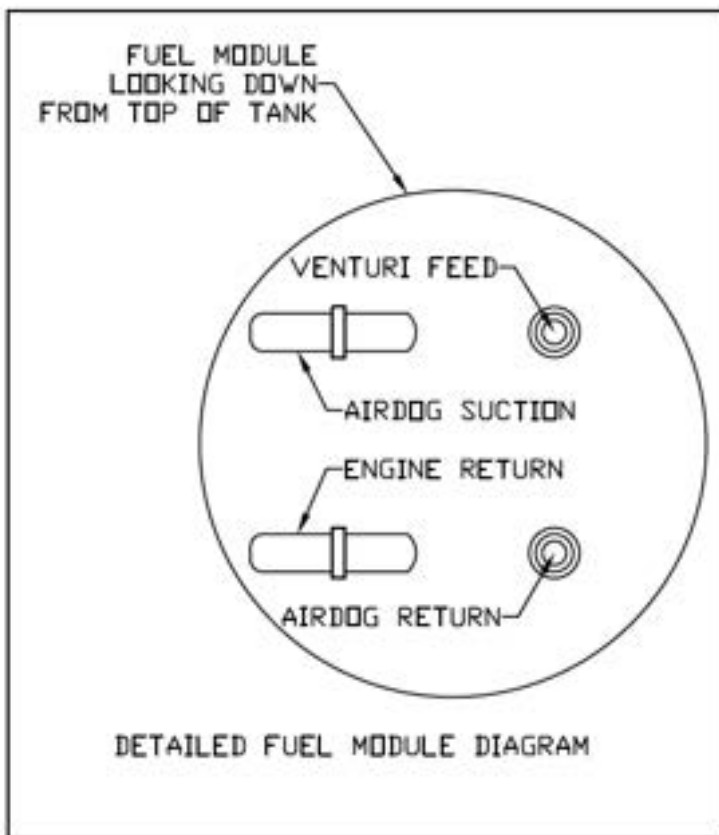

Drop the Fuel Tank from the Truck

For this application, it is necessary to drop the fuel tank to access the fuel module and fuel lines. It is recommended to use a transmission jack to steady the fuel tank as it dropped from the truck. This process will be easier if there is little to no fuel in the tank. **When dropping the tank, always remember, SAFETY FIRST!**

- 6-1.** Remove the tank skid plate. There will be 6 13mm bolts on the short bed that will need to be removed and 4 13mm and 2 17mm bolts on the long bed to be removed. Take care not to break the capture nuts. Be sure not to remove the tank strap bolts at this time.



Figure 1



Figure 2

- 6-2.** Now disconnect the fuel tank filler tube and tank vent from fuel tank using a phillips driver or 8mm socket. Once the clamps are loose, pull the rubber hose from the hard tubing.



Figure 3

- 6-3.** Once the filler and vent have been disconnected, support the fuel tank from the bottom using a transmission jack (Figure 4). Once supported, remove the tank strap bolts. Be sure to not damage the capture nuts in the frame. These bolts are a 13mm.



Figure 4



Figure 5

- 6-4.** Before dropping the fuel tank, disconnect the wiring at the top of the fuel module by depressing the connector tab while pulling directly back (Figure 6). If there is dirt in the connector, it may be necessary to clean the connector beforehand. You will also need to disconnect the water in fuel (WIF) sensor from the fuel-conditioning module (Figure 7).



Figure 6



Figure 7

- 6-5.** With all the above items disconnected, slowly lower the fuel tank. Ford designed these fuel tanks to be lowered quite a ways with the factory lines still connected. As the tank is lowered, just pop the lines from their holders on top of the tank.



Figure 8

- 6-6.** Next, disconnect the factory return line at the fuel-conditioning module. Short bed trucks, the conditioning module is at the front of the tank and will have a 90 degree fitting with **blue tabs**. Long bed trucks, the module is in the middle of the tank between the tank and the frame rail and will have a straight fitting with **blue tabs** that is looped back to the conditioning module. In either case, it will be the fitting on top of the module.



Figure 9

- 6-7.** After the factory return line is removed, the next step is to remove the factory engine feed line on the frame rail. Short bed applications will have a straight fitting with **yellow tabs**. Long bed applications will have a 90 fitting with **yellow tabs**. Refer to step 6-8 on how to remove the factory fittings.



Figure 10

- 6-8.** Remove the factory quick connects by, first, lifting the lock (1) to the unlock position, then, by pressing down on the tab (2) while pulling the fitting away. Have a container or rag handy as some fuel will drain out. **Fittings with blue tabs are return fittings. Fittings with yellow tabs are pressure/supply lines.**

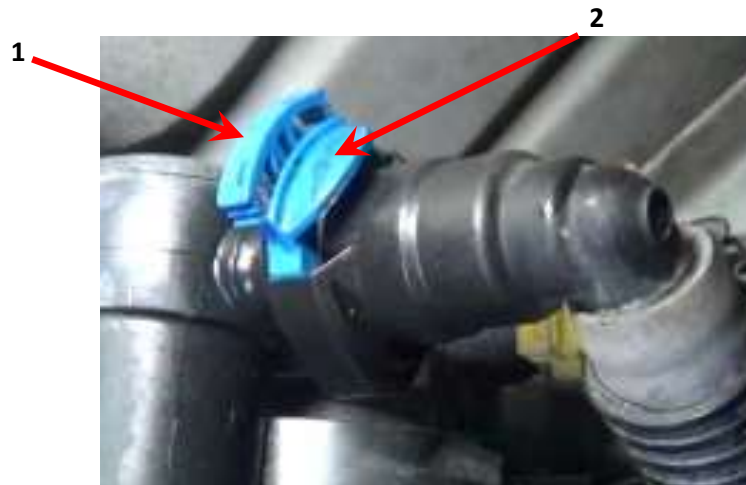

Figure 11

- 6-9.** If all of the previous steps have been completed, everything should be disconnected from the fuel tank. Once everything is verified to be disconnected, slowly drop the fuel tank the rest of the way down.



Figure 12

Remove the Fuel Module for Modification

For this application, the fuel module will need removed for modification. These modifications include removing the factory fuel pump, modifying the factory suction line, and tapping into the venturi line to keep the basket fill function. Once completed, the module will be reinstalled.

- 7-1.** First, using a 10mm, remove the protective plate on top of the module by removing the three nuts.

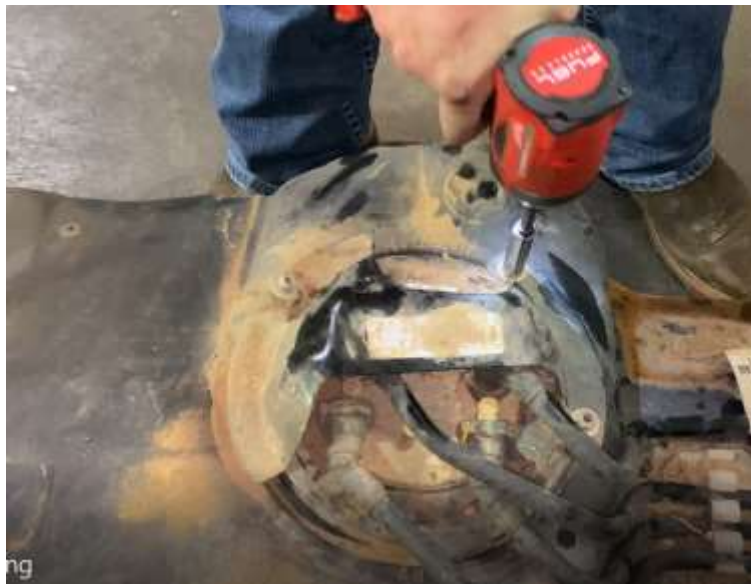

Figure 13

- 7-2.** Before the fuel module is removed, remove all of the fuel lines on top of the fuel module and conditioning module and thoroughly clean the top of the fuel module to keep dirt and debris from falling into the fuel tank. These fuel line fittings may have dirt under the tabs and may require thorough cleaning before they can safely be removed. Refer to step 6-8 for the steps to remove these fittings.

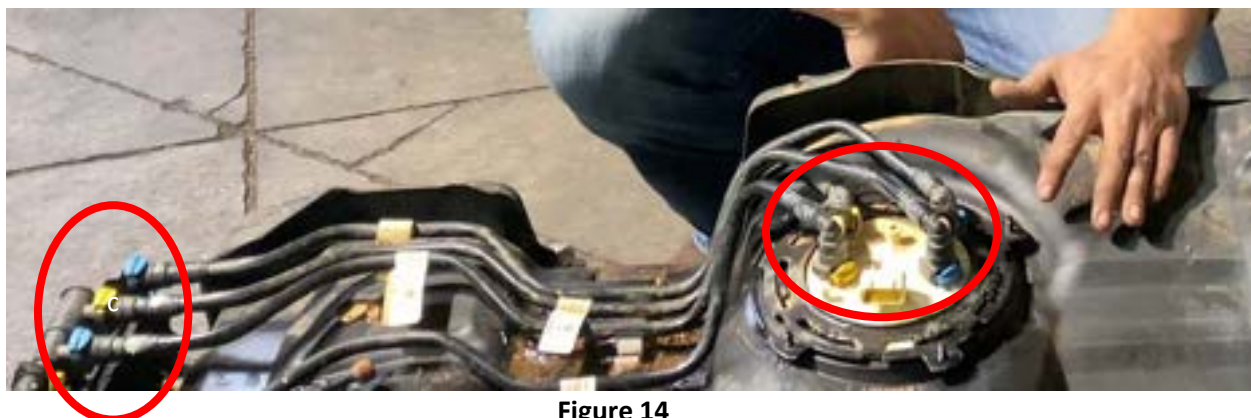

Figure 14

- 7-3.** Once the top of the fuel module has been cleaned, remove the fuel module from the fuel tank. Use a large flat head screwdriver or a pry bar and a hammer to loosen the lock ring by hitting it counter clockwise.



Figure 15

- 7-4.** Once the lock ring has been removed, the fuel module may be safely removed from the fuel tank. Take care to not damage the fuel level sender arm when removing the module. Have a container ready to catch any fuel that may be spilled.



Figure 16

- 7-5. Once the module is out, remove the fuel sending arm to keep it from getting damaged during the modification process.

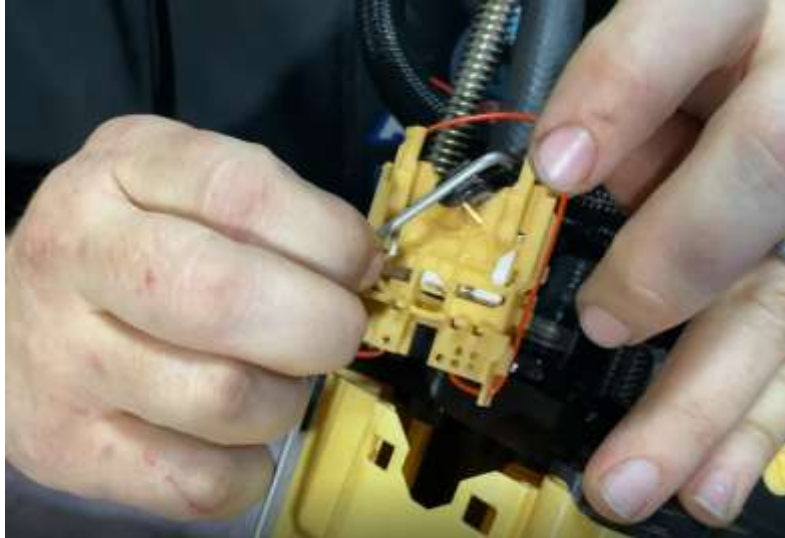

Figure 17

- 7-6. Before the fuel module is modified, it is a good idea to label the fittings to better understand the processes in the following steps.

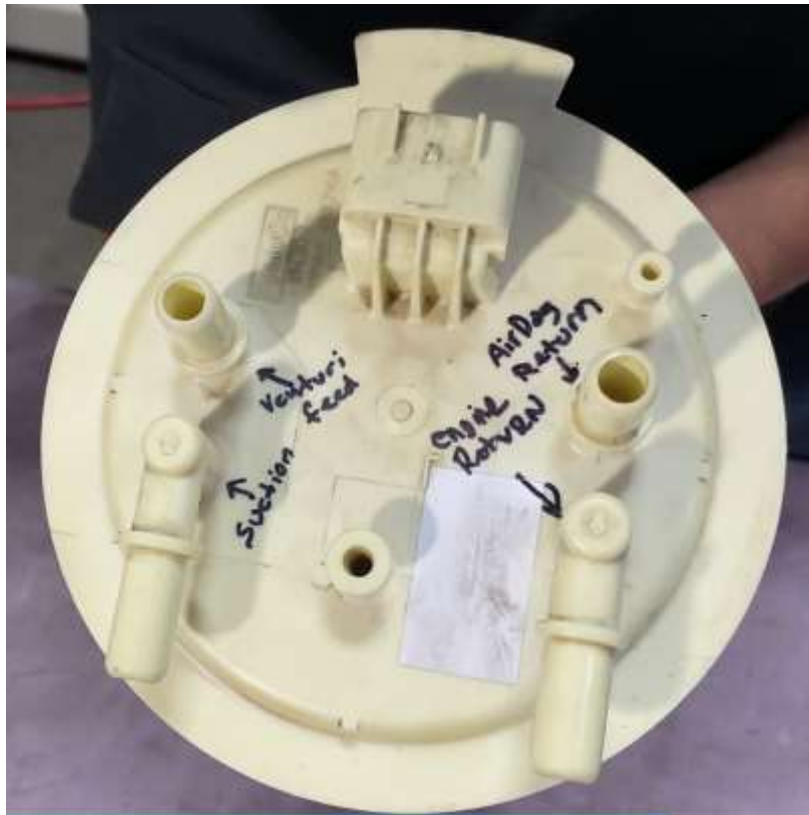

Figure 18

- 7-7. First step in the modification process is to cut the venturi line in the center of the module. It is the clear line coming from the edge of the black dome. **It is crucial that the end on the black dome is cut and not the end in figure 20.**

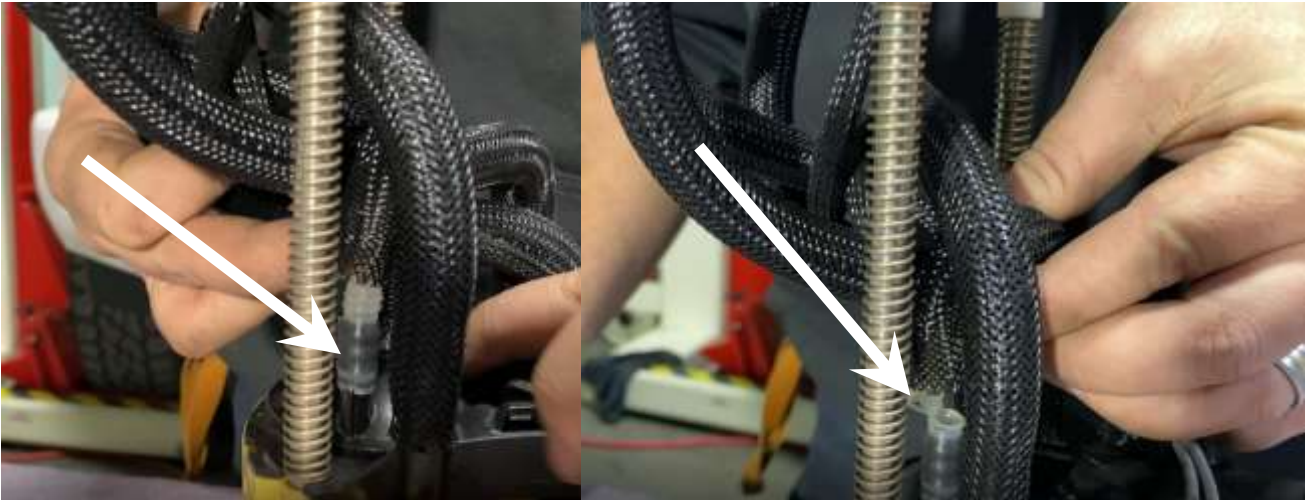

Figure 19

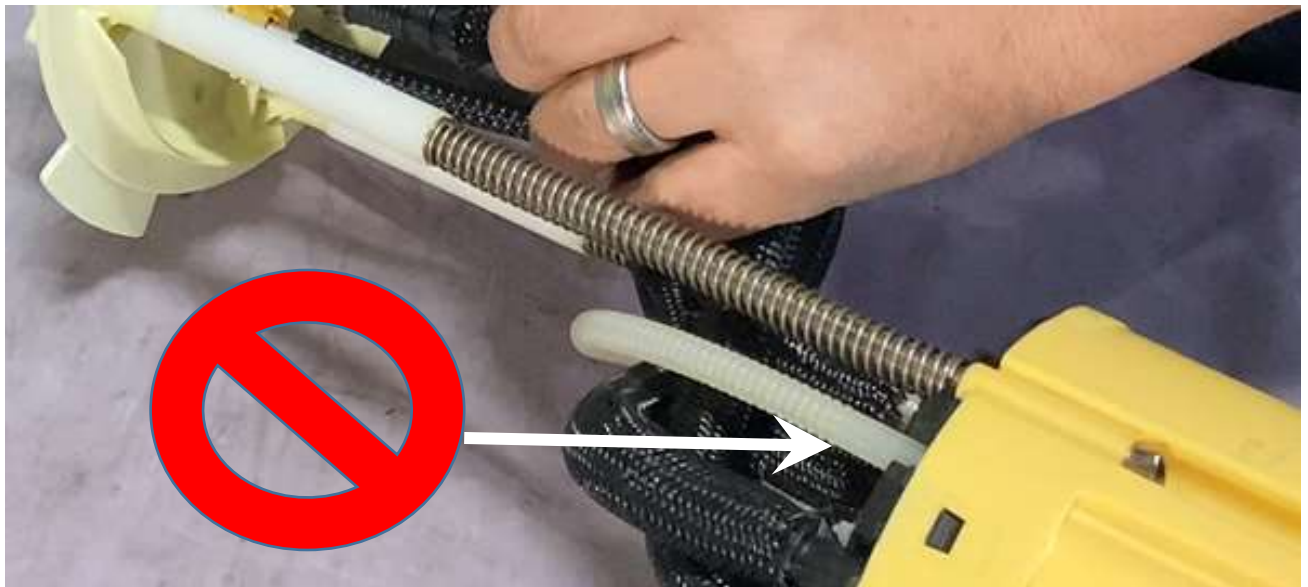

Figure 20

- 7-8.** With the venturi line cut, the module can be separated. The guide rods are staked to keep them from coming out. Using a grinder with a cutoff wheel, grind the staked part down enough to be able to pull through the plastic guide.



Figure 21

- 7-9.** Using several screwdrivers, undo all of the clips around the basket and pull the basket from the rest of the assembly.



Figure 22



Figure 23

- 7-10.** Before the factory fuel pump can be removed, the wiring must be disconnected. There is a connector and a ground to be removed.



Figure 24

- 7-11.** Using a screwdriver, pry the fitting in figure 25 away from the pump housing.



Figure 25

- 7-12.** Now remove the fuel pump retaining basket by undoing the three clips and remove the fuel pump.



Figure 26



Figure 27

- 7-13.** Now the fuel pump is removed, the basket will need to be reassembled. Be sure the lines disconnected in step 7-11 fit back in their slots in the assembly.



Figure 28



Figure 29

- 7-14.** To keep the assembly together, use a flat head screwdriver to stake the guide rod similar to how it was before it was ground down.



Figure 30



Figure 31

- 7-15.** Since the factory fuel pump will no longer be used, go ahead and remove the rest of the wiring in the module by undoing the connector under the top of the module.



Figure 32

7-16. Next, cut the factory fitting of the bottom of the fitting labeled “Venturi Feed” using a razor and pull off the factory line. Be careful to not gouge the barbs with the knife.

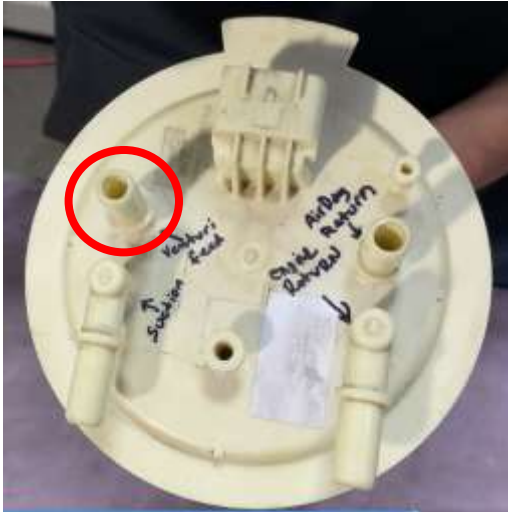

Figure 33

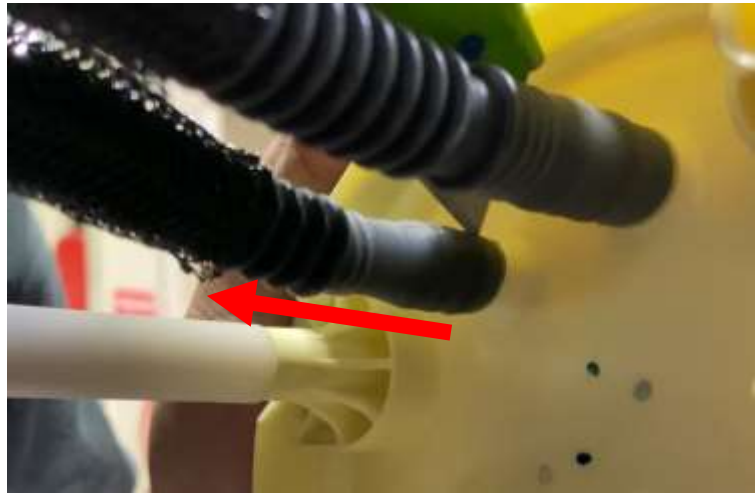

Figure 34

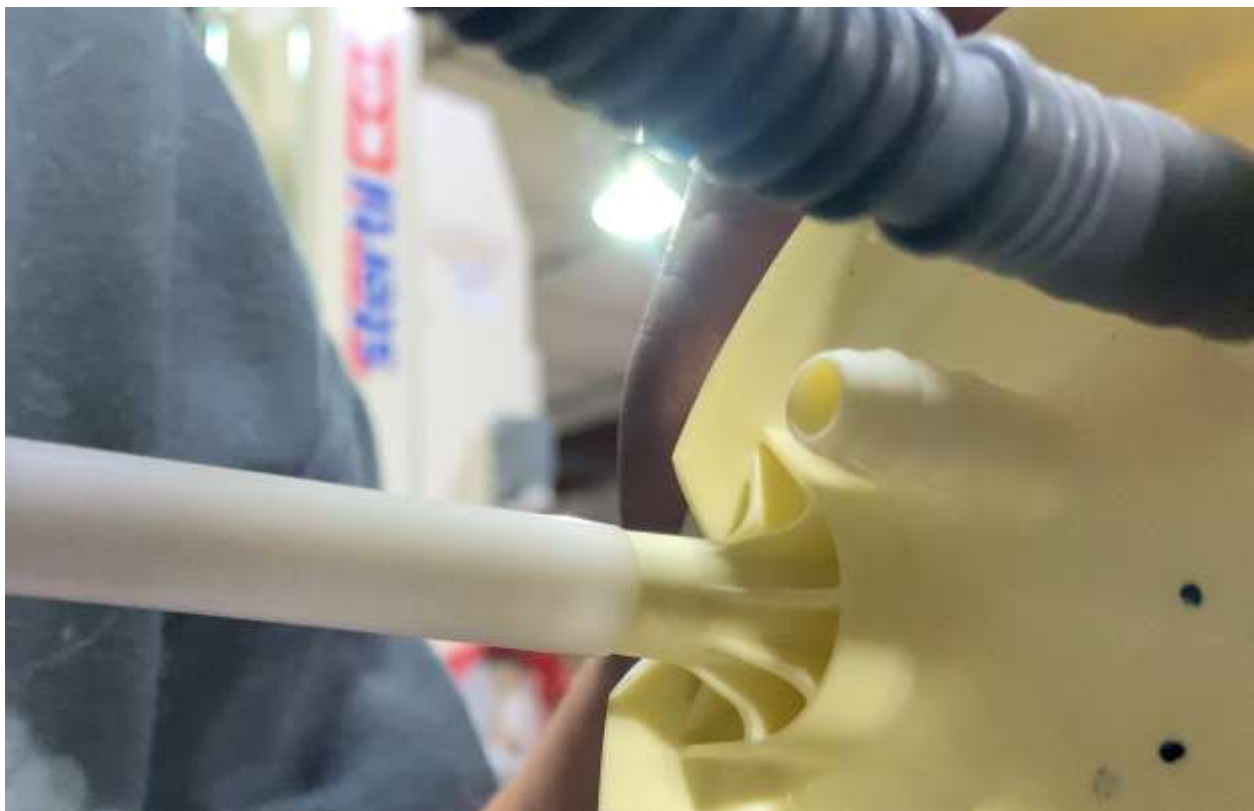

Figure 35

- 7-17.** You can now cut the other end of this fuel line to remove it from the module. The other end of this line is next to the line you cut in step 7-7. It is on the edge of the module basket. Be sure to not gouge the barbs.

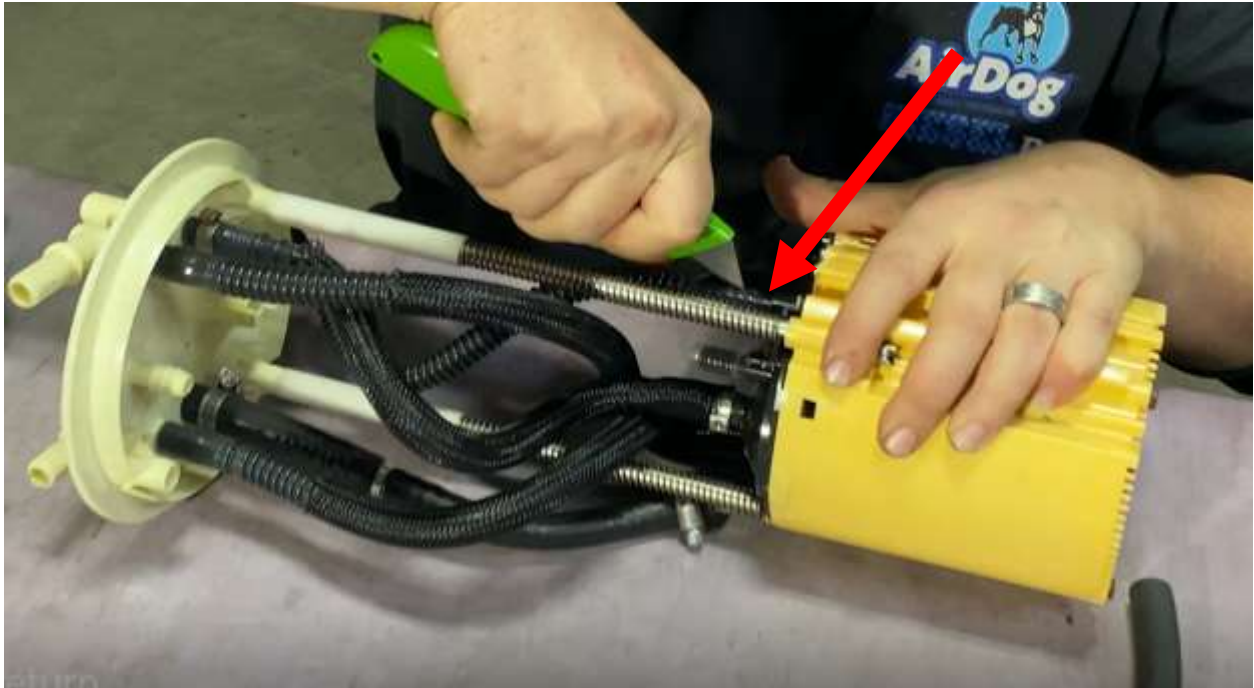

Figure 36



Figure 37

- 7-18.** With that factory line removed, the venturi feed line can be made. Using the 3/8" fuel line (P/N HS3801) and a small hose clamp, install the 3/8" hose onto the barb at the top of the module. The same barb that is in step 7-16. Use clean motor oil or ATF to lubricate the hose to make the installation easier. Once the fitting is pressed on, tighten the hose clamp.

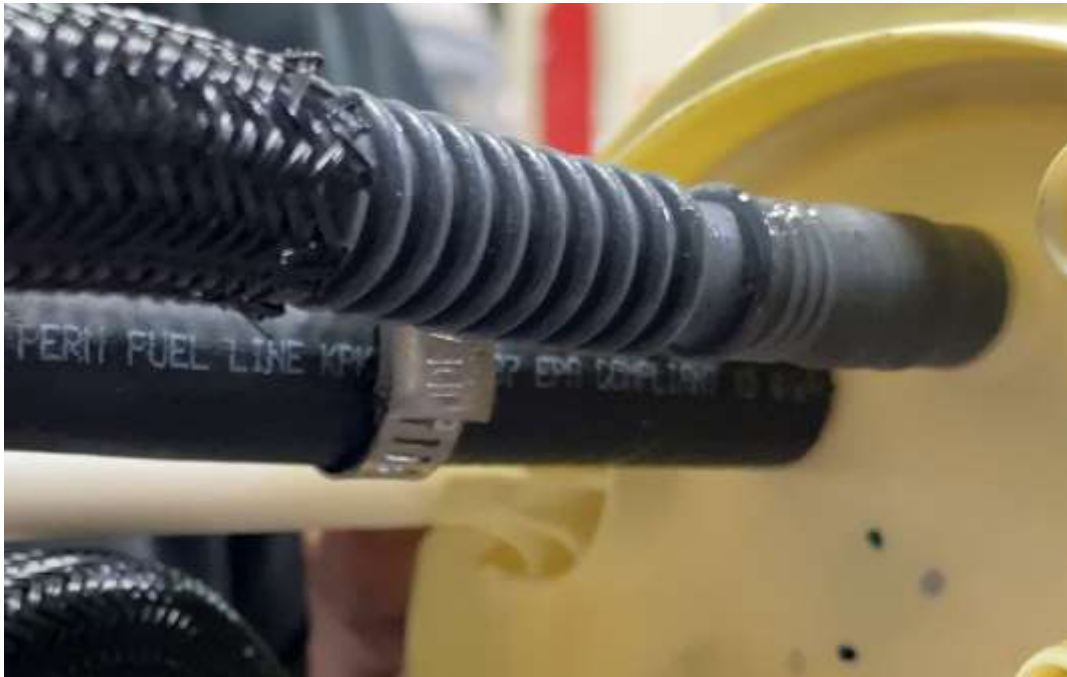

Figure 38



Figure 39

- 7-19.** Next, cut the 3/8" fuel line to where there is enough room to press the large end of the 4A-1-09-04-06-ST into it. Once cut, lube the barbed end of the fitting and the inside of the 3/8" line with clean motor oil or ATF and press it in. **These barbs are not push to lock and require a hose clamp! Use hose clamp 4C-2-1-12 and tighten till snug.**

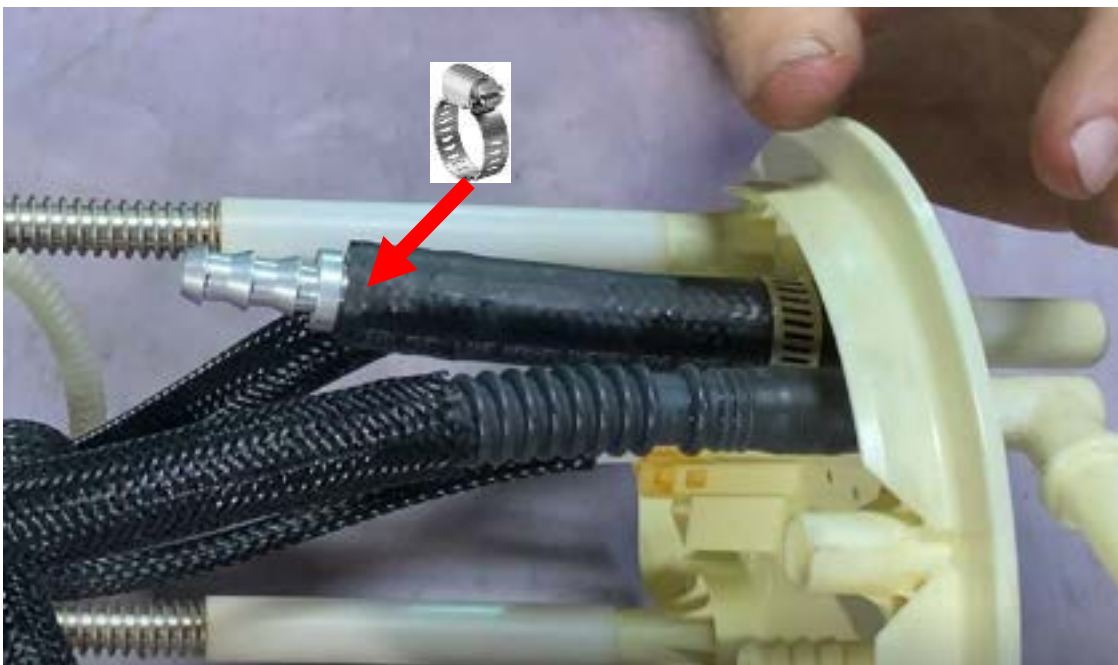

Figure 41

- 7-20.** Next, take the 5/16" line (P/N 4C-1-02-05-001) and push it over the clear corrugated factory venturi feed line that was cut in step 7-7. Use clean motor oil or ATF to ease the installation. Use one of the smaller hose clamps to tighten once installed. You may need to trim the clear line for clearance.



Figure 42



Figure 43

- 7-21.** Run the 5/16" fuel line up to the adapter fitting that was installed in the 3/8" fuel line in the previous step. Mark where to cut the line. Make sure there is enough line for when the basket is uncompressed and route the hose to where it does not kink when the basket is compressed. Once the correct length is determined, cut the line, lubricate the fitting and the inside of the line, then press it onto the barbed fitting. **Use hose clamp 4C-2-1-12 to secure the line to the 5/16 hose barbs. Tighten the hose clamp till snug. Do a pull test to be sure the line will not pull off the barbs! This line sees 60-70 psi of fuel pressure!**

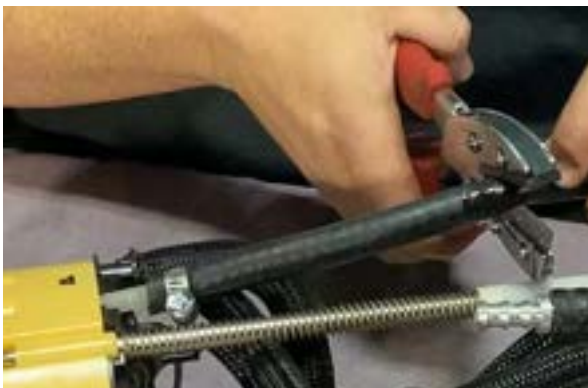

Figure 44



Figure 45



7-22. Now that the venturi feed line has been completed, the next step is to modify the fuel module to accept the AirDog return. Returning the fuel from the AirDog to the basket will also help keep the basket full in low fuel situations. You will need to cut off the factory fuel line from the “AirDog Return.” There is a compression clamp that will need to be removed by using a small screwdriver to pry the tab to loosen it (Figure 47). Once the clamp is removed, cut the fuel line off (Figure 48). Take care to not gouge the barbs on the fitting.

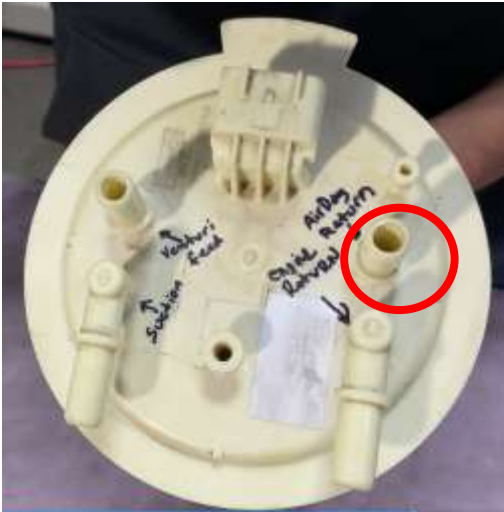

Figure 46



Figure 47



Figure 48



Figure 49

Section 7

Removing the Fuel Tank to Modify The Fuel Module

7-23. Follow that line that was cut off in the previous step down in the module and cut the other end off as this line is no longer used. It will be the line coming out of the center of the black dome. Discard this line.



Figure 50



Figure 51

7-24. Take the rest of the 3/8" fuel line (P/N HS3801) and press it on the fitting to where the line was removed in step 7-22. Use a small hose clamp to secure the connection.

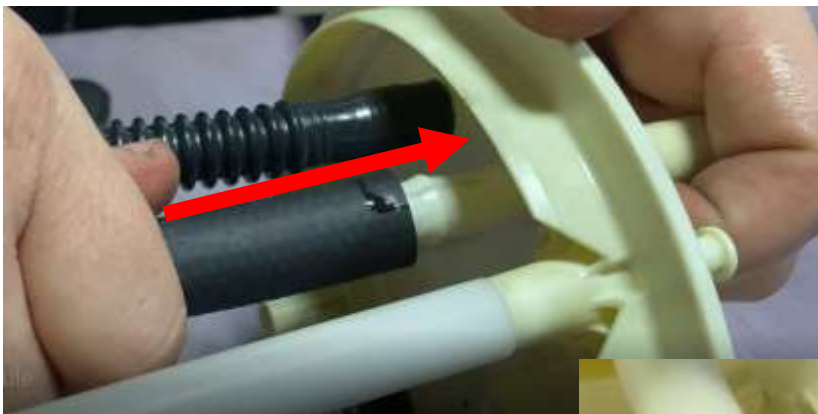

Figure 52



Figure 53

- 7-24.** Run the 3/8" fuel line down to the fitting to where the fuel line was cut off in step 7-17. Cut the fuel line to length making sure the basket can compress without kinking the hose and press it onto the fitting. Use the last small hose clamp to secure the line.



Figure 54



Figure 55

- 7-25.** The last step is to reinstall the fuel sending arm that was removed in step 7-5. Be sure to reconnect the wiring. Failure to do so and the truck will not be able to read the fuel level.



Figure 56

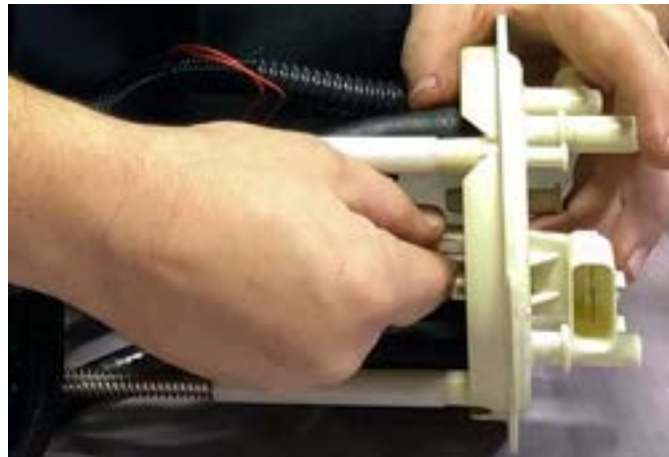

Figure 57

- 7-26.** Once the fuel module is complete, reinstall it into the fuel tank. Be sure the O-ring is reinstalled to avoid fuel leaks when the tank is full. Note, the tab on the fuel module is to be installed a certain direction. There is a mark on the fuel tank that indicates this direction.



Figure 58

- 7-27.** Reinstall the lock ring. The orientation of the lock ring does not matter when reinstalling as the protective plate that was removed in step 7-1 will not be reinstalled. Use a hammer to knock the ring clockwise until fully seated.



Figure 59

7-28. Hover the fuel tank below where it mounts about a foot to be able to have plenty of room to run and hook up fuel lines.



Figure 60

Mount the AirDog II-5G to the Bed Bracket

The 17 and up Powerstroke requires a bed bracket to mount the fuel pump as the traditional mounting system will not work on these trucks.

- 8-1.** Using bolt kit 901-61-0102-PM-C-12, find the 4 5/16-18 cap screws, lock washers, and nuts and use them to mount the cradle bracket (P/N 001-3C-0004) to the bed bracket (P/N 010-3C-0005-F). Take note of the orientation of the cradle bracket to the bed bracket in figure 61 as this is the correct orientation for this application. Use a 1/4" allen key and 1/2" wrench to tighten the bolts.



Figure 61

- 8-2** Next use the 4 1/4-20 cap screws, lock washers, and nuts to mount the AirDog to the cradle bracket. You will need a 3/16" allen key and a 7/16 socket or wrench. Be sure the regulator is oriented in the direction that is in Figure 63.



Figure 62

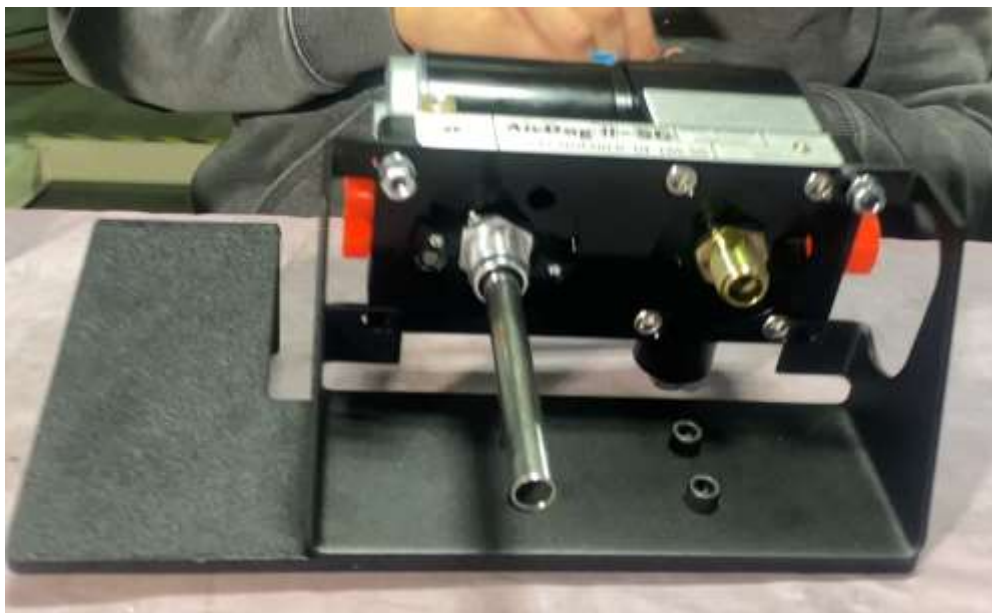

Figure 63

Note: The Data Plate on the 5G is removable and can be placed on the side of the pump facing out. For this application it may be necessary to install the Data Plate on the other side of the filter base.

Install the Fittings into the Pump

This fuel system comes with O-ring boss fittings instead of tapered thread fittings. These fittings eliminate the need for thread tape or pipe dope to get a good seal. Tighten the fittings until the O-ring is no longer visible for an easy leak free seal. The torque specs are as follows:

08J2044-3/4UNF 180in-lb or 15ft-lb

06J2044716UNF 84in-lb or 7ft-lb

- 9-1. Dip the threaded end of the 06J2044716UNF fitting into clean motor oil and hand-thread into the “RETURN” port of the the AirDog®II-5G filter base. Using a 9/16” deep socket, torque the fitting to 84in-lb or 7ft-lb. **DO NOT overtighten the fittings or damage may occur!**



Figure 64

- 9-2. Dip the threaded end of the 08J2044-3/4UNF fitting into clean motor oil and hand-thread into the “ENGINE” and “INLET” ports of the AirDog®II-5G filter base. Using a 7/8” deep socket, torque the fittings to 180in-lb or 15ft-lb. **DO NOT overtighten the fittings or damage may occur!**



Figure 65



Figure 66

Mount the Pump/Bracket Assembly to the Truck

The mounting system for this application is made very easy with a bed bracket that keys into the frame. This kit does come with the socket needed to remove and install the reverse torx bed bolt.

- 10-1.** First, use the supplied reverse torx socket (P/N EP24) to remove the bed bolt closest to the cab on the driver side of the truck.



Figure 67



Figure 68

- 10-2.** Once the bed bolt is removed, remove the capture nut on the bed mount under the truck.

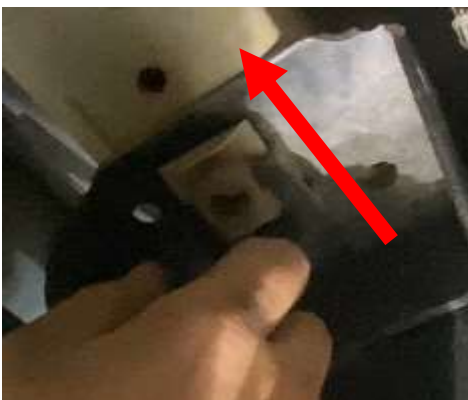

Figure 69



Figure 70

10-3. The tabs on the bed bracket allow the pump to hang in place while the bed bolt is reinstalled.



Figure 70



Figure 71



Figure 72

Assembling the Fuel Lines

This kit includes a length of fuel line and separate fuel line ends to allow for a much cleaner installation! Assemble the fuel lines as you install them. You will not want to pre-assemble the hoses or your lengths may not be correct!!!

- 11-1.** Take the fuel line end and lubricate the barbed end with clean motor oil or ATF (Figure 73) and press it into the fuel line (HS20) until all of the barbs are covered (Figures 74 and 75). The fuel line end should look like Figure 75.



Figure 73



Figure 74



Figure 75

- 11-2.** Now plug that fuel line with that fitting into the connection on either the AirDog or the truck where the manual calls it out.
- 11-3.** Run the fuel line along the frame away from any hot or moving parts such as exhaust or driveshafts (Figure 76). Cut the hose to length and insert the other fuel line end that the manual calls out into the fuel line as outlined in step 11-1.



Figure 76

NOTE: Hose clamps are not needed for these push-lock connectors. Hose clamps will cause damage to the hose!

Factory Return Line

Since the Fuel Conditioning module is bypassed, the factory engine return needs to be hooked up to the fuel module by using some AirDog fuel line and Fittings.

- 12-1.** Install the 90 degree return line adapter (P/N 001-4B-1-0067-17) into the factory return line on the frame. It will be a line with a blue clip. Remember, factory return lines are blue clips and feed lines are yellow clips. Figure 77 is for a short bed. A long bed will have a return line that is near the center of the fuel tank as illustrated in Figure 78.



Figure 77

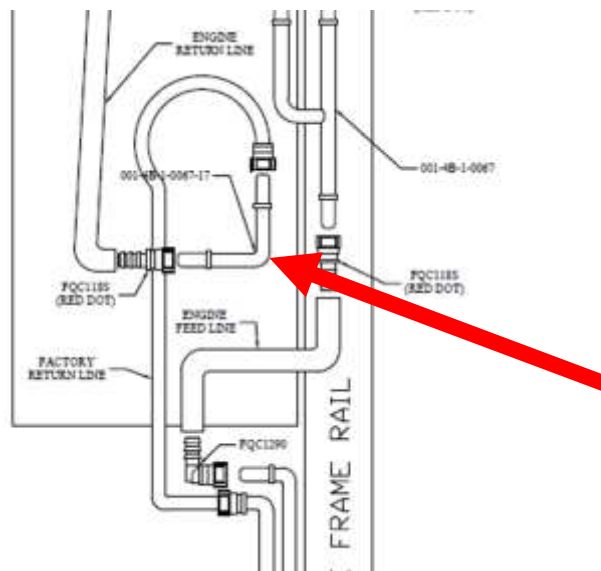

Figure 78

- 12-2.** Using fuel fitting FQC118S, assemble one end of the fuel line by pressing the fitting into the fuel line. Reference section 11. The FQC118S has a red dot on the fitting and reads “11.8” on the fitting. Once pressed in, connect it to the other end of the return 90 fitting. A “Click” will be heard when properly connected.

VERY IMPORTANT: There are two types of straight fuel fittings in this kit. One is standard (1/2in) which is labeled 12.61 and the other is metric (11.8mm) which is labeled 11.8 and has a red dot. The metric fitting is used here.

Figure 79



Figure 80

- 12-3.** Run the fuel line along on top of the fuel tank to the fitting labeled “Engine Return.” Cut the fuel line to length and press in fuel line fitting FQC1290. Once the fuel line is pressed in, connect it to the fuel module connection. A “click” will be heard when properly connected. Be sure the line is routed in a manner to where it will not get pinched when the tank is fully installed.

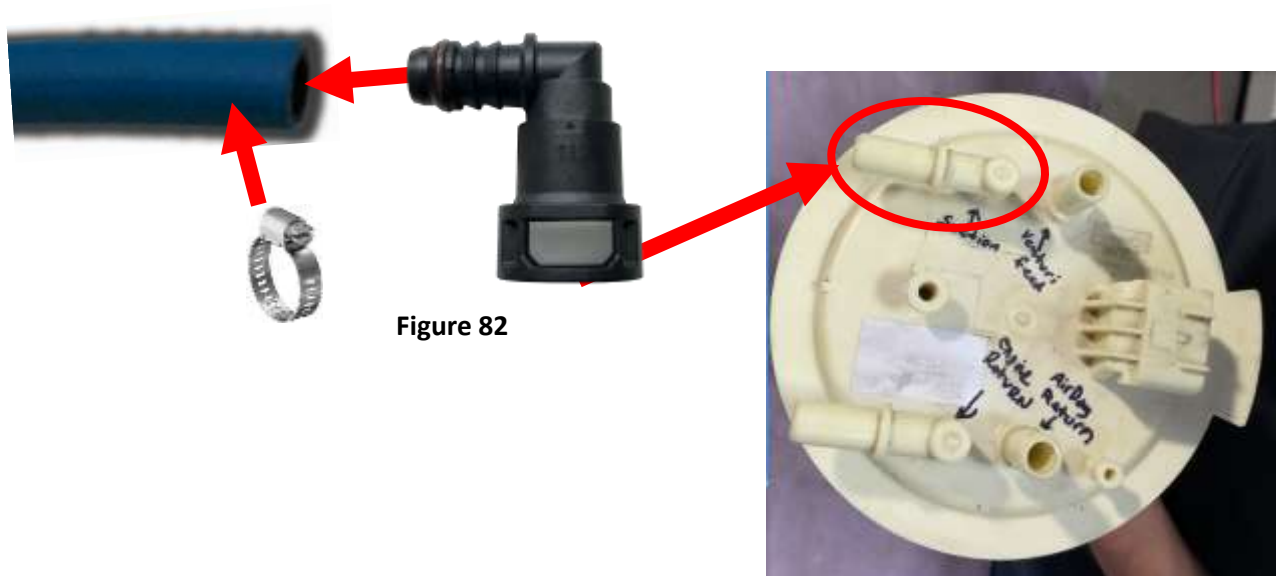

Figure 81

AirDog Suction Line

The next line to make is the AirDog Suction line. This line is what pulls fuel from the tank and supplies the AirDog with fuel.

- 13-1.** Start by pressing fuel line FQC11890 (90 degree fitting with a Brown O-ring) into a section of HS20 and using a hose clamp to secure the connection. The reason we use a hose clamp on this fitting is because this fitting is not a push to lock and requires a hose clamp. Once connected, press the fitting on the connection on top of the fuel module labeled "Suction." A "Click" will be heard once properly connected.



- 13-2.** Route the fuel line to the "Inlet" of the AirDog. Be sure to route it in a way to where the hose will not be pinched once the tank is fully installed. Cut the line to length and press in fuel line fitting FQC12S. Once pressed in, connect it to the AirDog "Inlet" fitting. A "click" will be heard once properly connected.

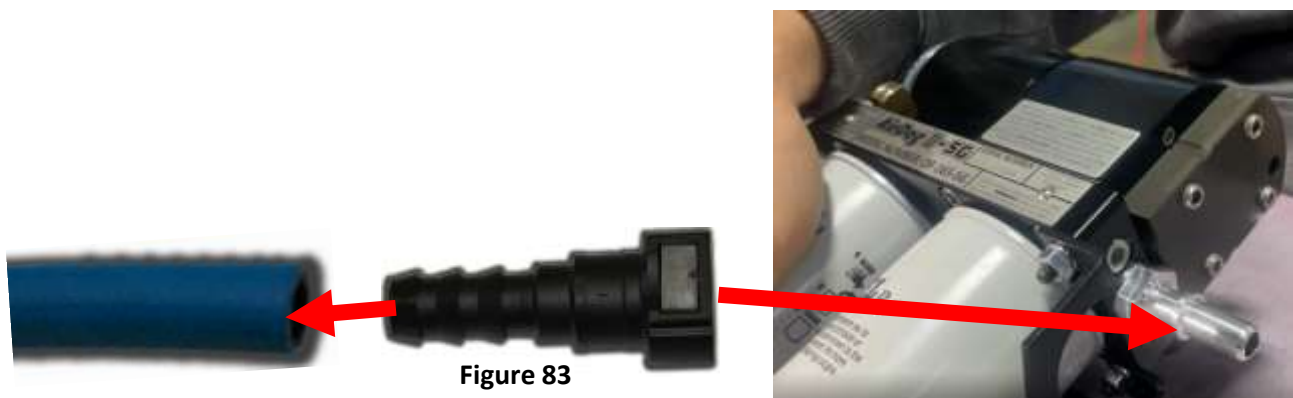

AirDog Return Line

The AirDog return is returned back to the fuel module to help keep the basket full during low fuel situations.

- 14-1.** Start by pressing fuel fitting FQC1290 into a section of the HS20 and connecting to the top of the module that is labeled “AirDog Return. A “click” will be heard once properly connected.

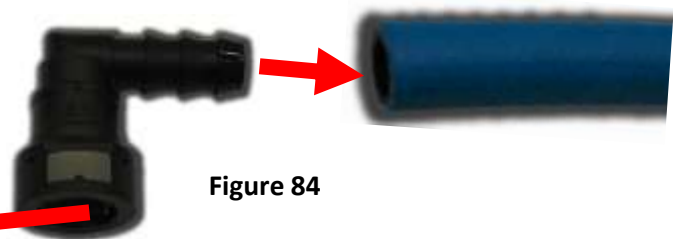

Figure 84

- 14-2.** Run the fuel line to the Return fitting on the AirDog and cut the line to length. Remember to make sure the line will not be pinched once the tank is final installed. Press in fuel line fitting FQC38S into the fuel line and connect it to the Return port “R” on the AirDog.

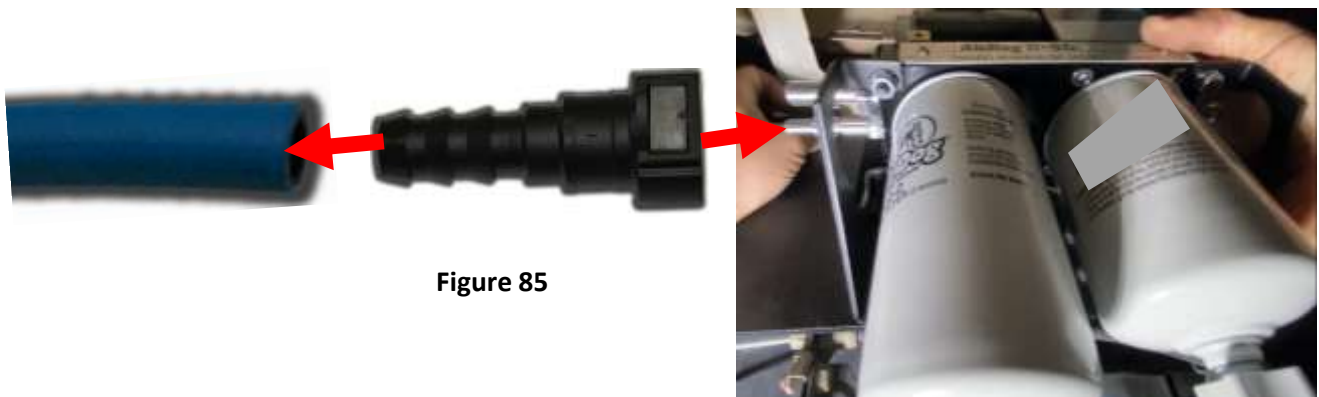

Figure 85

Engine Feed and Venturi Feed Line

This is the most complex fuel line that will need assembled for this kit. The Feed line to the engine is spliced by a return “Y” fitting. This splice sends pressurized fuel back to the fuel module to feed the Venturi to keep the basket full.

- 15-1.** First, press fuel line end FQC12S into a section of HS20 and connect it to the “Engine” fitting in the AirDog. A “click” will be heard when properly connected.



Figure 86

- 15-2.** Next, run the other end of the fuel line along the frame to the factory engine feed line and cut the line to length. Press in a FQC12S for a short bed application and a FQC1290 for a long bed application and connect it to the factory feed line fitting. A “click” will be heard when properly connected.

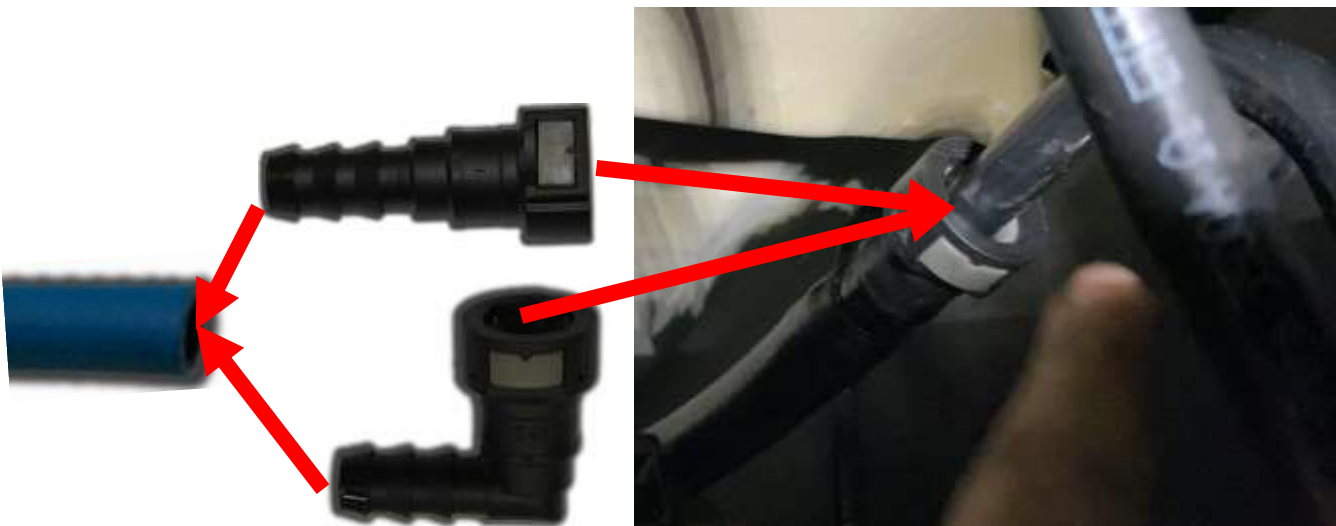

Figure 87

15-3. Once the Engine Feed line has been completed, choose a spot in that line to install the return “Y” splice (P/N 001-4B-1-0067). Make sure the location that is chosen gives plenty of room for the fuel lines when the tank is fully installed. Once the location has been chosen, cut the feed line.

15-4. Use 2 fuel line ends FQC118S and press them in either side of the Engine Feed line that was cut. Once the fittings are pressed in, install the Return “Y” splice. Point the open end of the “Y” towards the fuel module. A “click” will be heard on both fittings once properly connected.

VERY IMPORTANT: There are two types of straight fuel fittings in this kit. One is standard (1/2in) which is labeled 12.61 and the other is metric (11.8mm) which is labeled 11.8 and has a red dot. The metric fitting is used here.



Figure 88



Figure 90

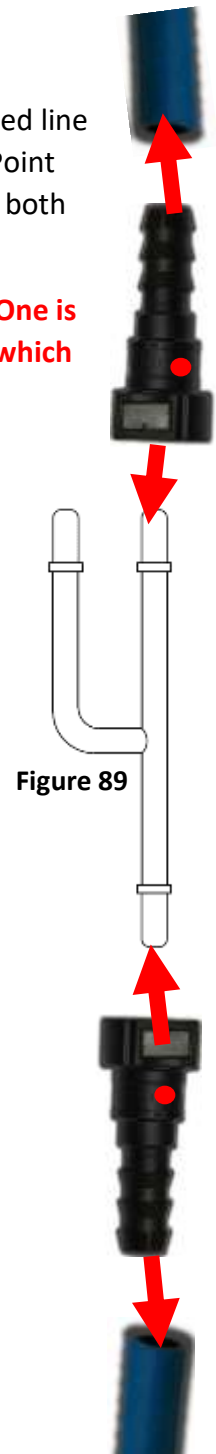

Figure 89

- 15-5.** The very last fuel line to make is the Venturi Feed line. This line will go from the Return “Y” splice back to the fuel module to the fitting labeled “Venturi Feed.” Start by pressing fuel line end FQC38S into a section of HS20 and pressing it onto the open fitting on the Return “Y” splice. A “click” will be heard when properly connected.



Figure 91



- 15-6.** Next, run the fuel line to the fitting on top of the fuel module named “Venturi Return” and cut the fuel line to length. Use fuel line end FQC11890 (90 degree fitting with a Brown O-ring) and press it into the fuel line and use a hose clamp to secure the connection. Again, this 90 fitting is not a push to lock and requires a hose clamp for a secure connection. Once complete, press it onto the fuel module fitting named “Venturi Return.” A “click” will be heard when properly connected.

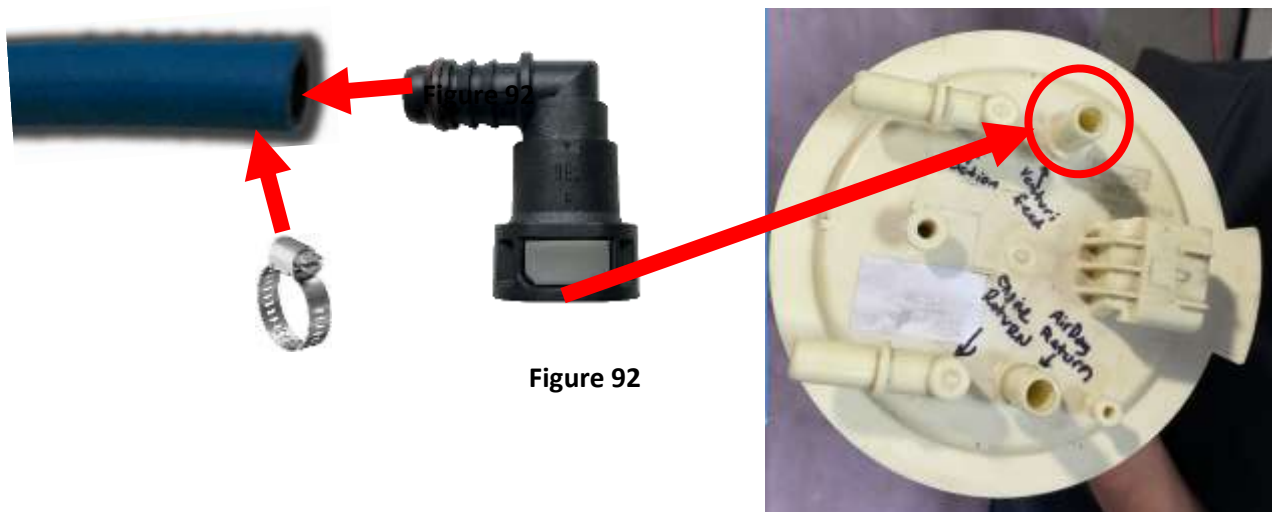

Figure 92

Installing the Jumper Wiring Harness

This kit comes with a wiring harness that jumps power from the factory wiring and sends it to the AirDog pump while jumping the fuel level sender wires so the dash can read fuel level. The motor RPM on our pump is controlled the same as a factory system. Please note, Ford's fuel module wiring is proprietary and there is not a readily available connector to purchase for our use. For this reason, we had the connectors 3D printed. They work like the injection molded connectors, they just don't look as pretty. This harness comes with a 25 Amp fuse. The factory harness is 30 Amp.

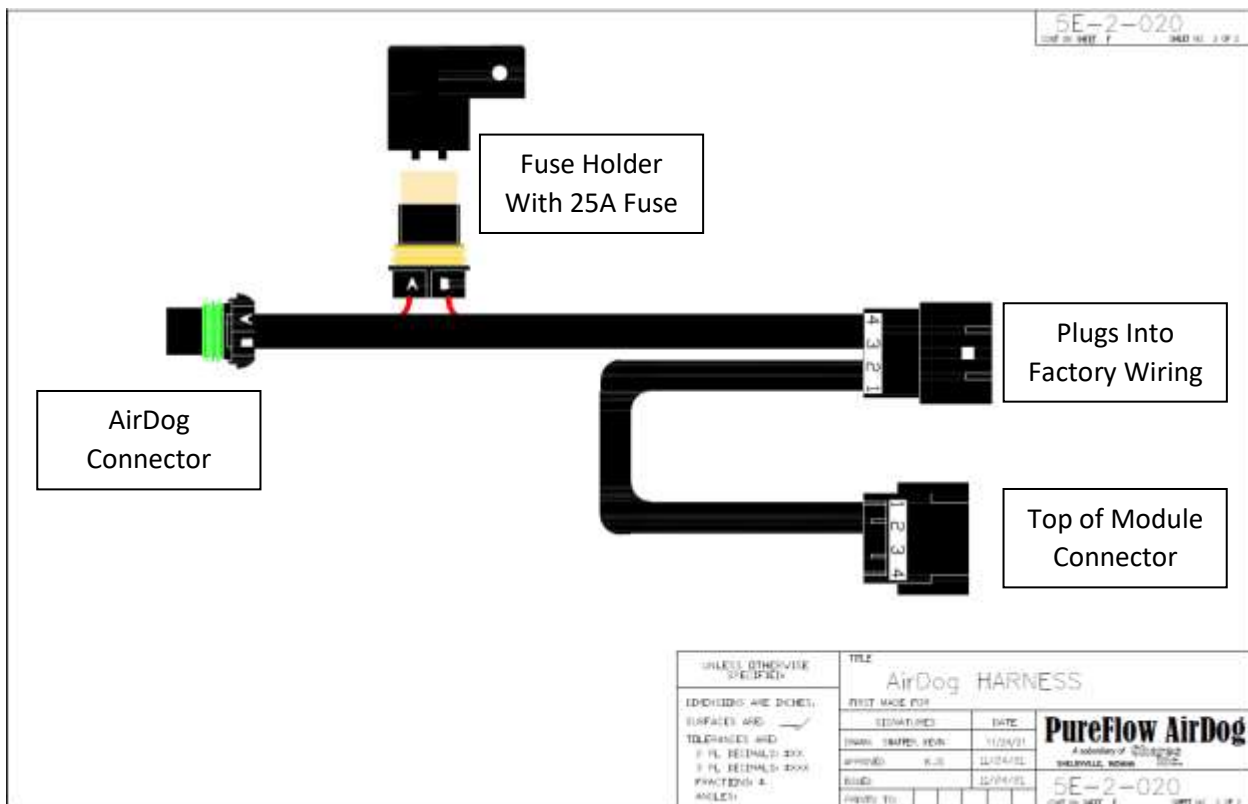

Figure 93

- 16-1.** First, Connect the connector on top of the fuel module. A “Click” will be heard when properly connected. It is recommended to pack dielectric grease around the pins before installing.



Figure 94

- 16-2.** Connect the other connector to the factory wiring hanging from the frame rail. You may have to pull the lock out of the factory connector to get it to fully seat. A “click will be heard once properly connected. It is recommended to pack the pins full of dielectric grease before installing.



Figure 95

- 16-3.** Run the AirDog connector up over the frame to the AirDog and connect it. A “click” will be heard once properly connected.



Figure 96

- 16-4.** Make sure where the harness is routed, that none of the wiring will be pinched once the fuel tank is final installed.

Final Installation of the Fuel Tank

After all of the fuel lines have been assembled and installed and the wiring harness has been hooked up, the fuel tank can be final installed.

- 17-1.** Put the fuel tank up and make sure nothing is pinched. Reinstall the tank straps using the factory bolts and 13mm socket wrench. Be sure the filler tubes are slid back up over the frame rail.



Figure 97

- 17-2.** Once the tank straps are all installed, reinstall the tank skid plate using the factory hardware and a 13mm socket wrench.



Figure 98

- 17-3.** Reconnect the filler neck tube and the tank vent using an 8mm socket or phillips screw driver.



Figure 99

- 17-4.** Be sure to reconnect the WIF sensor wiring to avoid any check engine lights.



Figure 100

Starting Procedures

- With the batteries hooked back up, key the truck on to prime the AirDog. You will hear the tone of the pump change when the system is primed.
- Once the system is primed, it is highly recommended to install a fuel pressure gauge to check the fuel pressure. The pressure should be about 60psi at idle. If the pressure is not 60psi at Idle, adjust the fuel pressure per section 21.
- Once fuel pressure has been verified, check the fuel fittings to make sure there are no leaks. If there are leaks, address the leaks. If there are no leaks, go ahead and start the truck.



FILTER SERVICE RECOMMENDATIONS

Plugging of either the fuel filter or the water separator itself will cause low fuel pressure and low flow to the engine. If a low fuel pressure issue exists, replace the fuel filter. Typical fuel filter life is 15-20k miles depending on fuel quality.

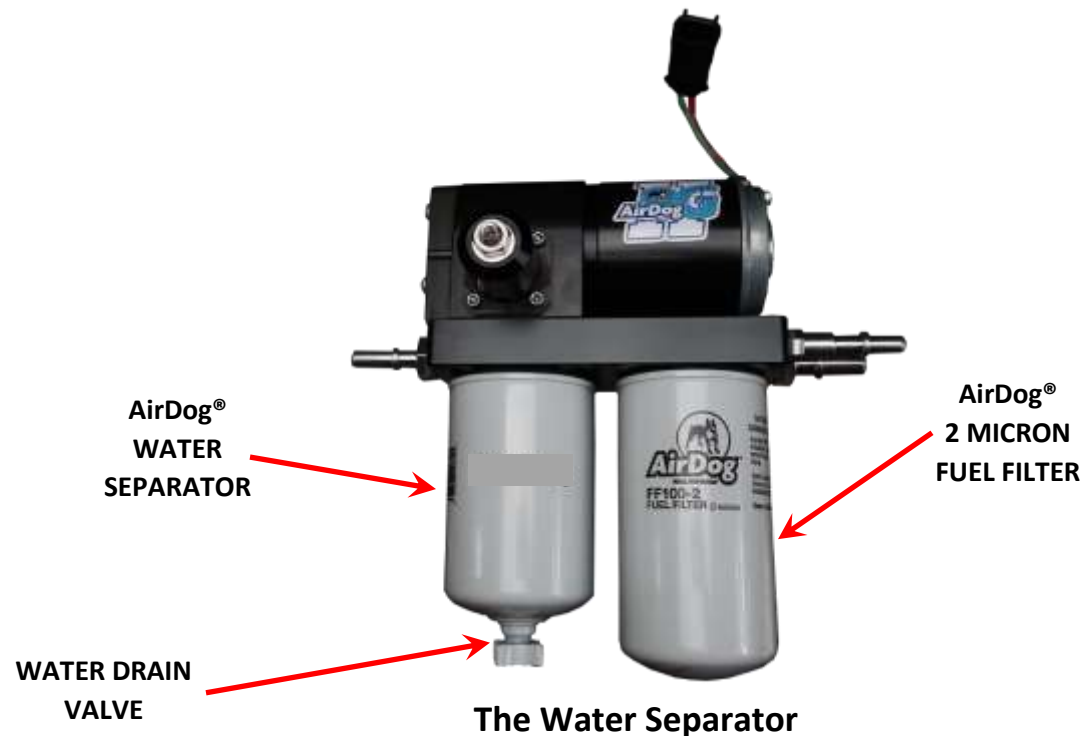

Replace the water separator every other time you change the Fuel Filter or if it becomes damaged or plugged. It is suggested to check/drain the water separator every three months or as needed should you experience excessive 'water in fuel' conditions. When installing the water separator, be sure to clean the underside of the AirDog® base. Follow the instructions printed on the pre-filter for proper tightening procedures.

CAUTION: Be extremely careful to prevent any contaminants or debris from entering the pre-filter when removing it for cleaning! Large debris will jam the Gerotor and cause the fuse to blow. This is not a warranty item. Should this happen, you can easily put the system back into working order. See the instructions on "How to clean the Gerotor" for proper procedures.

The Fuel Filter

Remove the fuel filter by turning it counter clockwise. **DO NOT** pre-fill the fuel filter with fuel. The AirDog® will fill the filter and prime the system automatically. Follow the instructions on the filter for proper tightening procedures.

CAUTION: Dispose of waste fuel and used filters properly

CLEANING DEBRIS/CHECKING FOR DAMAGE IN/TO THE GEROTOR ASSEMBLY

STEP 1: Remove the four (4) socket head cap screws that secure the Gerotor cap using a 3/16 allen wrench.

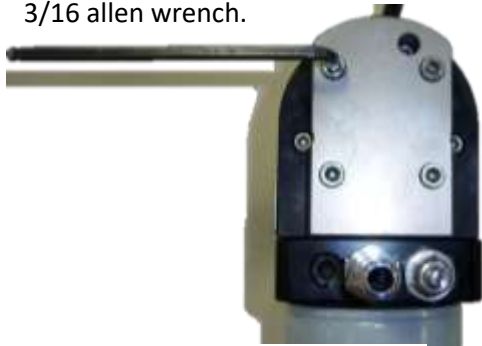

STEP 2: Carefully remove the O-rings you will need to reuse them.



STEP 3: Remove and clean the Gerotor. Be very careful to not damage the Gerotor.

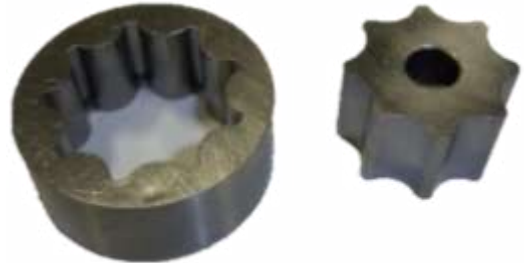

STEP 4: Remove the O-rings and clean/inspect the inside of the Gerotor pocket.



STEP 5: Reinstall the center gear.



STEP 6: Align and install the outer gear and O-rings.



STEP 7: Install the Gerotor Cap. Be very careful not to dislodge or pinch the O-rings.



STEP 8: Loosely assemble the cap screws. Torque the cap screws in an opposing pattern.

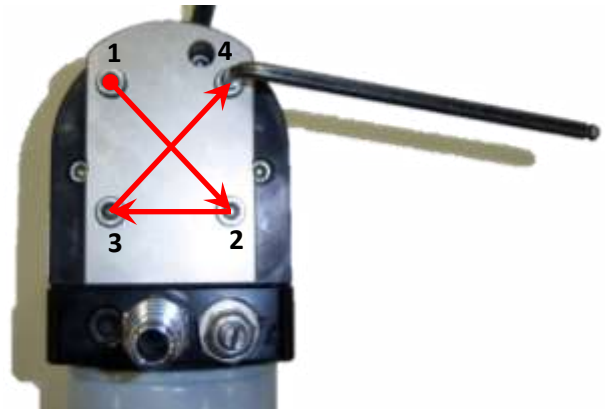

If there is damaged found to either the Gerotor, Gerotor pocket, or O-rings, call into AirDog® Tech Support for further assistance.

AirDog®II-5G ADJUSTABLE FUEL PRESSURE REGULATOR

The AirDog®II-5G rises to a new level of performance with an adjustable diaphragm fuel pressure regulator. This regulator offers more consistent fuel pressure and allows for higher flow rates at pressure. This regulator can also be boost compensated to battle any pressure drops under wide open throttle. The boost compensation kit is sold separately.

PRESSURE ADJUSTMENT FOR THE 6.7L POWERSTROKE

Loosen the Jam Nut with a 5/8 wrench
Re-torque after adjustment



Use a 3/16 allen to adjust the pressure
regulator



**PRESSURE
ADJUSTMENT**

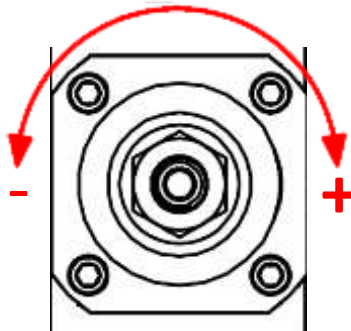

**PRE-SET AT 60PSI @ 9V
AND 70PSI @ 13V**

Turn the adjuster screw counter-clockwise to reduce the output pressure or clockwise to increase the pressure. Be sure to re-torque the jam nut after adjusting the regulator. **IT IS STRONGLY RECOMMENDED TO ADJUST THE PRESSURE WHILE USING A FUEL PRESSURE GAUGE. TOO MUCH OR TOO LITTLE PRESSURE MAY CAUSE DAMAGE TO THE INJECTION SYSTEM!**

Every AirDog II-5G has a 90-degree brass fitting in the pump to where you can add a fuel pressure gauge or fuel pressure sending unit for an electric gauge.



PUREFLOW AIRDOG
LIFETIME LIMITED EXPRESS WARRANTY

FOR

Covered PureFlow AirDog I, II and Raptor Systems

IMPORTANT NOTICE

TO ACTIVATE YOUR PURFLOW AIRDOG WARRANTY, YOU MUST COMPLETE AND MAIL YOUR WARRANTY CARD TO PUREFLOW AIRDOG WITH A COPY OF YOUR ORIGINAL SALES RECEIPT WITHIN 30 DAYS OF PURCHASE. FAILURE TO COMPLETE AND SUBMIT YOUR WARRANTY CARD WILL RESULT IN A WARRANTY PERIOD OF THE COVERED PRODUCE TO ONE (1) YEAR FROM THE DATE OF PURCHASE.

PureFlow AirDog (hereafter collectively, "SELLER") warrants and guarantees only to the Original Purchaser (hereafter collectively, BUYER) that All PureFlow AirDog Systems (hereafter collectively, PRODUCT) shall be free from defects of materials and workmanship in the manufacturing process for as long as the BUYER owns the PRODUCT.

The Lifetime Limited Express Warranty is limited to the PRODUCT purchased by the original BUYER of the PRODUCT and limited solely to the parts contained within the PRODUCT and EXCLUDES ALL ELSE INCLUDING FILTERS AND WATER SEPARATORS. Any PRODUCT that is in question of Warranty must be returned, shipped prepaid, to PureFlow AirDog. All Warranty claims are subject to the approval of PureFlow AirDog. If it is determined that a Warranty claim exists, PureFlow AirDog will, at its sole discretion, replace the defective PRODUCT with a comparable PRODUCT, repair the defective PRODUCT, or refund the BUYER'S purchase price in exchange for the PRODUCT. Repairs or replacements are warranted for only the remainder of the original warranty period and only to the original BUYER.

Under no circumstances shall the SELLER be liable for any labor charged or travel time incurred in the diagnosis for defects, removal, or reinstallation of the PRODUCT, or any contingent expense.

Under no circumstances will the SELLER be liable for any damage or expense incurred by reason of the use or sale of the PRODUCT.

Other than expressly set forth herein, the SELLER shall in no way be responsible for the proper or improper use and service of the PRODUCT. In no event shall the SELLER be liable for any special, incidental, indirect or consequential damages of any kind or nature, whether or not the BUYER of the PRODUCT was advised of the possibility of damage or harm, arising or resulting from the use or performance of the PRODUCT and BUYER hereby waives the right to any and all such claims.

BUYER, acknowledges that he/she is not relying on SELLER'S skill or judgment to select or furnish goods suitable for any particular purpose and that SELLER has no liability that will extend beyond the scope of the LIMITED EXPRESS WARRANTY contained herein, and BUYER hereby waives all remedies or liabilities, expressed or implied, arising by operation of law or otherwise.(including, without limitation, any obligation of SELLER with respect to fitness for any particular purpose; merchantability; and special, incidental, indirect or consequential damages) or whether or not occasioned by SELLER'S negligence.

SELLER disclaims any warranty and expressly disclaims any liability for personal injury or damages related to BUYER'S use of the PRODUCT. BUYER acknowledges and agrees that the disclaimer of any liability for personal injury is a material term for this agreement and BUYER agrees to indemnify SELLER and hold SELLER harmless from any claim related to the PRODUCT and its use or performance. Under no circumstances will SELLER be liable for any damages, liabilities, costs or expenses incurred as a result of or by reason of use, performance or sale of the PRODUCT, including without limitation, any damages, liabilities, costs or expenses incurred by reason of BUYER'S negligence related to those uses of the PRODUCT.

The proper installation of the PRODUCT is the sole responsibility of the BUYER. The SELLER assumes no liability regarding improper installation or misapplication of the PRODUCT.

SELLER hereby provides the following limited warranty as to description, quality, merchantability, fitness for the PRODUCT'S purpose, productiveness, or any other matter of SELLER'S PRODUCT sold herewith. The SELLER shall be in no way responsible for the open use and service of the PRODUCT and the BUYER hereby waives all rights other than those expressly written herein. This Warranty shall not be extended or varied except by a written instrument signed by SELLER and BUYER.

IN THE EVENT THAT THE BUYER DOES NOT AGREE WITH THIS AGREEMENT, THE BUYER MAY PROMPTLY RETURN THE PRODUCT, IN A NEW AND UNUSED CONDITION, WITH A DATED PROOF OF PURCHASE, TO THE PLACE OF PURCHASE WITHIN THIRTY (30) DAYS FROM THE DATE OF PURCHASE FOR A FULL REFUND. THE BUYER AGREES THAT THE INSTALLATION OF THIS PRODUCT CONFIRMS THE BUYER HAS READ AND UNDERSTANDS THIS AGREEMENT AND ACCEPTS THE TERMS AND CONDITIONS OF THIS AGREEMENT.

Warranty Procedure

In the unlikely event a warranty appears as if it may be warranted, the following steps are taken:

- 1 The customer discussed the symptoms of the problem with a PureFlow AirDog Technician. The customer is to have the system Serial Number and Model Number available for the Technician when the call is made. This will expedite all steps of the process.
- 2 The customer performs any and all tests requested by the PureFlow AirDog Technician. This is done to isolate the potential problem while eliminating potential installation or maintenance related issues,
- 3 If the PureFlow AirDog Technician determines based on the customer feedback concerning the requested testing that system may be at fault, the customer is advised that all returned pumps are tested upon arrival and should this returned pump perform at design criteria upon arrival, the customer will be charged a \$50.00 fee.
- 4 The PureFlow AirDog Technician will first request the customer's phone number in the event the phone call is accidentally disconnected and then transfer the customer to a PureFlow AirDog Customer Service Representative. Should a Customer Service Representative not be available, the Technician will offer the Customer the option to hold, call back, or receive a return call.
- 5 The PureFlow AirDog Customer Service Representative will check to determine if the customer's Warranty Registration Card is on file.
 - a. If no Warranty Registration is found, the customer will be required to supply the original purchase receipt showing the purchase date.
 - b. If no Warranty Registration is found, the customer will be advised of the options should the system in question is out of the default warranty period (1 year).
- 6 The PureFlow AirDog Customer Service Representative will request the customer information, including: Name, Address, Phone Number, Model Number, Serial Number, Year / Make / Model of vehicle, Name of Dealer purchased from, Purchase Date, Description of Problem, Customers' understanding of the resolution, and customer credit card information.
- 7 PureFlow AirDog will cover Ground Shipping charges to ship the replacement unit and will include a prepaid shipping label for the return of the defective unit. Any additional items ordered at the time of the replacement shipment will include their portion of the shipping cost.
- 8 A period of 15 Calendar Days from the time of shipment is provided for the receipt of the defective unit at the PureFlow AirDog facility. Failure to return ship the defective unit to arrive within the defined time period will result in a charge of \$250.00 against the customer's credit card as the purchase cost of the defective unit.

Revised November 15, 2024