

#59

AirDog II DF-165

FUEL PREPARATOR

INSTALLATION MANUAL FOR 6.0L POWERSTROKE POWERED **FORD TRUCKS**

2003-2007

**HIGH PERFORMANCE FUEL SYSTEM
WITH QUICK CONNECT COMPONENTS**

**PLEASE READ THESE INSTRUCTIONS THOROUGHLY
BEFORE BEGINNING THE INSTALLATION**



PUREFLOW AIRDOG
705 W MAUSOLEUM RD
SHELBYVILLE, IN 46176

877-421-3187
PUREFLOWAIRDOG.COM

CANADIAN PATENT
2,108,391

PROTECTED BY
US PATENTS
5,355,860; 5,746,184; 6,729,310

AUSTRALIAN PATENT
2005101054

NEW ZEALAND PATENT
532356

Additional Foreign Patents Pending in Europe, South America, Mexico, Japan, and China!

AirDog® II-5G



SMALL and COMPACT

7" Long X 3.2" Wide X 10" Tall

OVERVIEW

Thank you for your purchase and welcome to PureFlow AirDog's AirDog®II-5G fuel air separation and delivery system for the 2003-2007 6.0L Powerstroke.

The AirDog®II-5G is an all in one premium fuel pump and filtration system for the 6.0L. This system removes water, particulates, and entrained air from the diesel fuel. The entrained air that is separated from the fuel is returned to the tank through a small return fitting. The fuel is delivered to the engine at the correct pressure and flow rate to meet the demands of the engine under all operating conditions.

The AirDog®II-5G DF-165 systems feature a built in adjustable diaphragm pressure regulator. All AirDog®II-5G systems include a complete installation kit.

The AirDog®II-5G, for this particular application, is preset at 50-55psi from factory for a stock application. The regulator is adjustable up to 70 psi for fine tuning the system for performance upgrades.

WARNING: RUNNING THE PUMP ABOVE 70PSI WILL DECREASE THE LIFE OF THE PUMP SIGNIFICANTLY AND MAY VOID THE WARRANTY.

PureFlow AirDog products are manufactured in Shelbyville Indiana by a team of skilled workers with unsurpassed attention to detail and using the most stringent quality assurance.

HOW THE 5G OPERATES

The AirDog®II-5G DF-165 draws fuel from the fuel tank. The fuel is then drawn through the water separator where 92% of water is removed per SAE spec 1488. It is then pressurized through a Gerotor pump and sent to the 2 micron fuel filter before it is sent to the injection pump. The air from aerated fuel, due to tank sloshing and engine return lines, is separated and sent back to the tank through the 3/8" return fitting. The excess fuel that the engine does not use is recirculated through the diaphragm regulator back to the suction side of the pump.

QUICK CONNECT COMPONENT OVERVIEW

Provided in this kit is an OE style quick connection system. This system works to allow a quick, clean, and professional install.

SAE J2044 QUICK CONNECT SYSTEM

The SAE J2044 quick connect system is the most commonly used system in the automotive industry. The images below show the formation of SAE J2044 connection. To connect the assemblies, simply insert the male end form into the mating female connector. Push firmly until you hear it “click” into place. To disconnect the fittings, press down and hold the tabs on the female connector while you firmly pull the assembly apart.



TABLE OF CONTENTS

Section 1.....Table of Contents
Section 2.....Installation and Safety Guidelines
Section 3.....Parts List

INSTALLATION PROCEDURES

Section 4..... Fittings, Brackets, and Mounting

Fuel Lines

Section 5.....Fuel Line Assembly
Section 6A.....Supply Line to Engine
Section 6B.....Return Line to Tank
Section 6C.....Suction Line from Tank

Electrical Harness

Section 7.....Electrical Harness
Section 8.....Final Check List

Maintenance

Section 9.....Filter Service Recommendations
Section 10.....Cleaning the Gerotor Assembly
Section 11.....The Pressure Regulator
Section 12.....Warranty

AirDog® II-5G MODEL DF-165

INSTALLATION GUIDELINES

The installation of your AirDog®II-5G can be relatively easy by following the steps outlined in this manual, and:

1. Inventory the package components completely. Notify *PUREFLOW AIRDOG* immediately of any missing or damaged parts. (877-421-3187)
2. Read the installation manual completely. Understand how the system operates and take note of installation recommendations before beginning installation.
3. The installation recommendations contained herein are suggested installation guidelines only. Individual installations may vary.
4. When installing the AirDog®II-5G fuel lines, be sure to connect the ORIGINAL ENGINE RETURN LINE to the fuel tank as it was from the factory when the installation is complete!

If any installation procedure is uncertain, contact

PUREFLOW AIRDOG for technical assistance.

SAFETY GUIDELINES!

- CAUTION!** Be sure to chock the vehicle's tires to prevent rolling.
- CAUTION!** Use proper supports when working beneath an elevated vehicle.
- CAUTION!** Most diesel pickups have two (2) 12volt batteries. Disconnect the battery cables to both batteries before proceeding with the AirDog®II-5G installation.
- CAUTION!** Vehicle frame rails should not be drilled into or welded upon.
- CAUTION!** Wear safety glasses when operating power tools such as drills and grinders or when using a punch or chisel.
- CAUTION!** Use common sense when routing fuel lines and electrical harnesses. Keep them away from hot exhaust components and/or moving parts. Properly secure lines to prevent chaffing.

NOTE: The pictures used in this manual are for example only and may not be exactly the same as your truck.

6.0L PowerStroke PARTS LIST

QTY	DESCRIPTION	PART NUMBER	IMAGE
1	AirDog®II-5G	DF-165	
1	AirDog®II Mounting Bracket	001-3C-0004	
1	Mounting Bracket Hardware Kit	901-61-0102-PM-F	
1	Frame Bracket	010-3C-0002 010-3C-0001	
1	Wiring Harness	5E-2-010-HD	
1	Air/Vapor Quick Connect Return "Tee" 5/16"x5/16"x3/8"	001-4B-1-0060	
1	Bundle of Plastic Ties	5H-2-1-06/12	
1	Spacer	010-3C-0003-A-P	
1	20ft of Fuel Line	HS20	
1	3/8" male J2044 Quick Connect to 1/2" Push Lock Fitting	MQC38	
2	1/2" Straight Hose Quick Connect Fitting	FQC12S	
2	3/8" 90° Hose Quick Connect Fitting	FQC3890	
1	3/8" Straight Hose Quick Connect Fitting	FQC38S	
1	Customer Service Oring Replacement Kit	901-05-0500	
2	1/2" Male J2004 Quick Connect x 3/4-16" UNF	08J2044-3/4UNF	
1	3/8" Male J2004 Quick Connect x 7/16" UNF	06J2044716UNF	

ILLUSTRATION OF QUICK CONNECT COMPONENTS

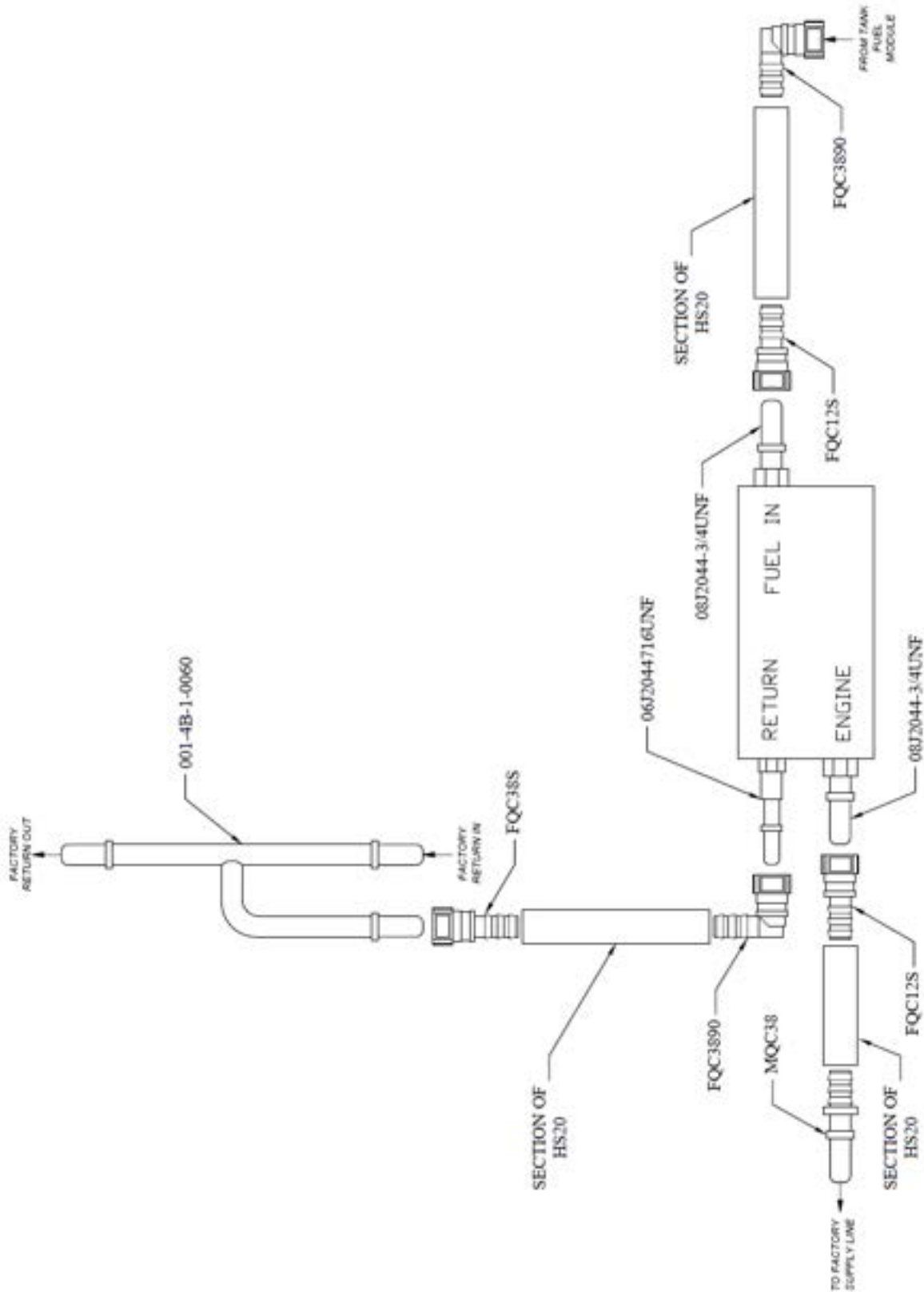

DRAWING NOT TO SCALE

Installing the Supplied Fittings Into the AirDog II-5G Base

- 4-1. Dip the threaded end of the 08J2044-3/4UNF fitting into clean motor oil and hand-thread into the “ENGINE” and “INLET” ports of the AirDog®II-5G filter base as illustrated in figures 1, 2, and 3. Using a 7/8” deep socket, torque the fittings to 180in-lb or 15ft-lb. **DO NOT overtighten the fittings or damage may occur!**
- 4-2. Dip the threaded end of the 06J2044716UNF fitting into clean motor oil and hand-thread into the “RETURN” port of the the AirDog®II-5G filter base as illustrated in figures 1 and 2. Using a 9/16” deep socket, torque the fitting to 84in-lb or 7ft-lb. **DO NOT overtighten the fittings or damage may occur!**

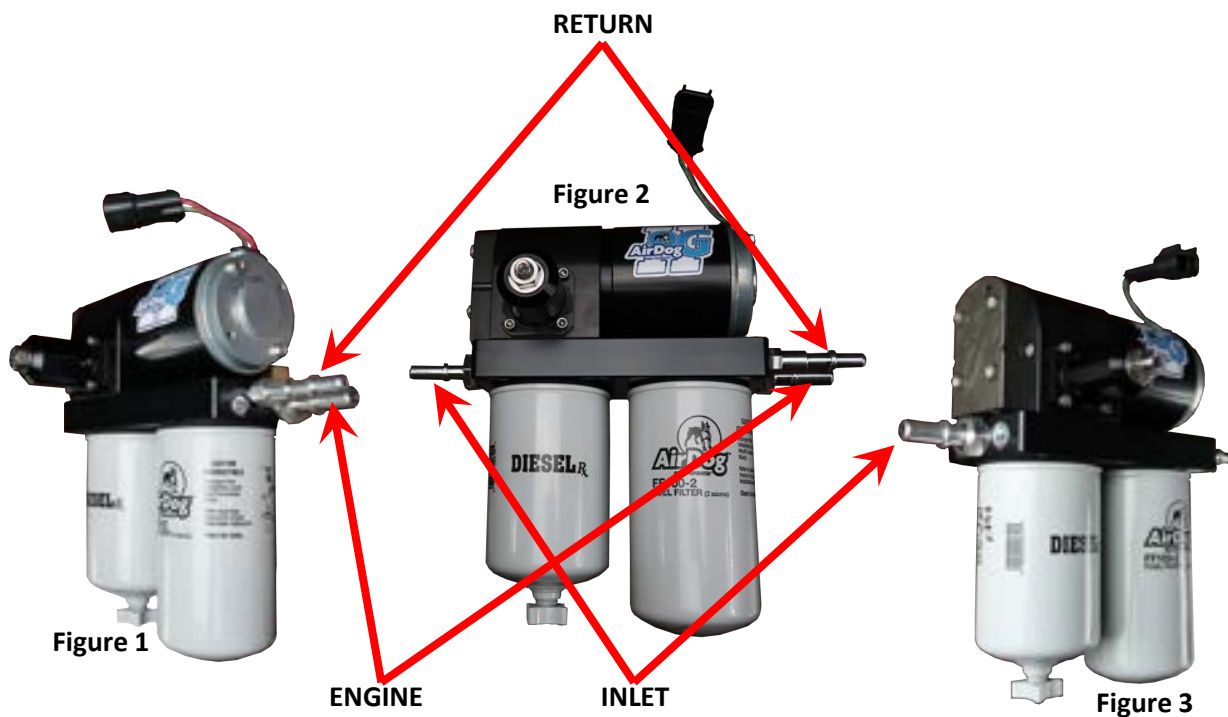

- 4-3. Assemble the AirDog mounting bracket (001-3C-0004) to the frame bracket (010-3C-0001) using the spacer (010-3C-0003-A-P) as shown in figure 4 using the four bolts, lock washers, and nuts included in the mounting bracket hardware kit (figure 5). Properly torque all fasteners! You will need a 3/16" allen and a 1/2" wrench. The bracket assembly should look like figure 6.

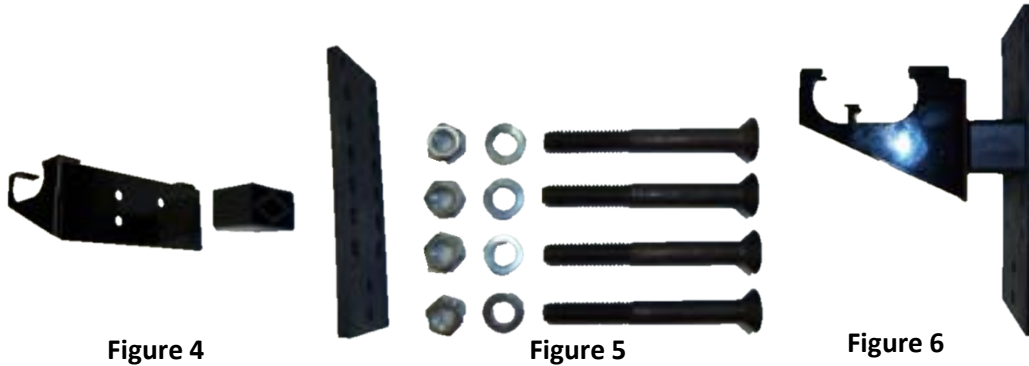

- 4-4. Attach the AirDog®II-5G to the frame bracket assembly as shown in figure 7 using the supplied hardware in the mounting bracket hardware kit. The brackets are universal and can be mounted anywhere there is room.



Figure 7

NOTE: We recommend installing the AirDog® on the inside of the frame rail, but we understand some applications just don't have the room. The photos in this manual may not be the same as your application.

- 4-5. Be sure to tuck the AirDog®II-5G as far up as possible without it rubbing on anything to prevent damage from road debris. The bracket assembly is adjustable to achieve this.

- 4-6. Clamp the frame between the AirDog® bracket assembly and the backing plate (figure 8) using the 3/8" bolts, lock washers, and nuts included in the kit. You will need two 9/16" wrenches. Properly torque all fasteners! **BE SURE** to mount the AirDog®II-5G with the "INLET" port toward the rear of the vehicle (Figure 8).

FUEL IN



Figure 8

Assembling the Fuel Lines

This kit includes a length of fuel line and separate fuel line ends to allow for much cleaner looking installations! Assemble the fuel lines as you install them. You won't want to pre-assemble the hoses or your lengths may be off.

- 5-1. Take the fuel line end and lubricate the barbed end with clean motor oil (Figure 9) and press it into the fuel line (HS20) until all of the barbs are covered (Figures 10 and 11). The fuel line end should look like Figure 11.



Figure 9



Figure 10



Figure 11

- 5-2. Now plug that fuel line with that fitting into the connection on the either the AirDog or the truck where the manual calls it out.
- 5-3. Run the fuel line along the frame away from any hot or moving parts such as exhaust or the driveshaft (Figure 12). Cut the hose to length and insert the other fuel line end that the manual calls out into the fuel line as outlined in step 5-1.



Figure 12

NOTE: Hose clamps are not needed for these push-lock connectors.

AirDog® II-5G SUPPLY LINE TO THE ENGINE

- 6A-1. Disconnect the fuel supply line to the engine from the OE fuel pump. You will need a fuel line disconnect tool. This tool is not included in the kit, but can be picked up at a local auto parts store. This pump is located on the driver's side inside frame rail (Figure 13).



FIGURE 13

- 6A-2. Push the male 3/8" J2044 Fitting (MQC38) into HS20 until all three barbs are not showing, then connect the fitting to the factory fuel supply line that was just disconnected in the previous step. A "click" will be heard once properly connected.

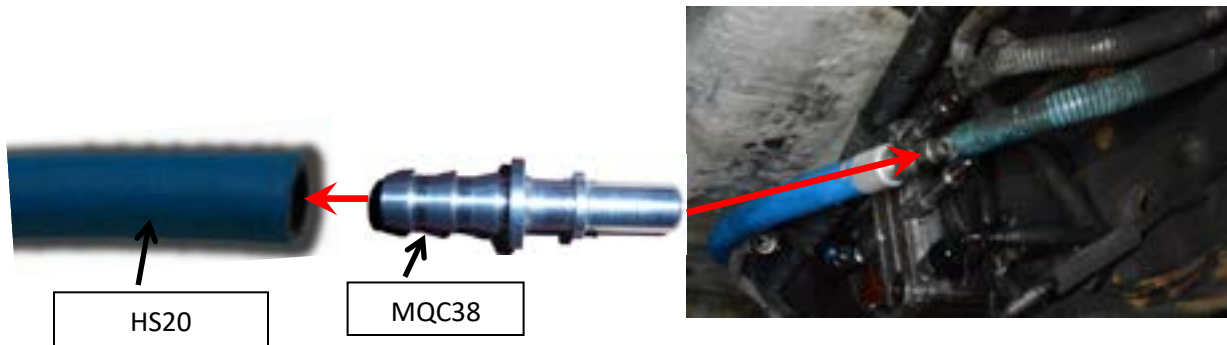

FIGURE 14

- 6A-3. Run the other end of the fuel line along the frame, away from any hot or moving parts, to the port in the AirDog base labeled “Engine.” Cut the fuel line to length and press in fuel line end FQC12S per section 5. Once the connector is pressed in, press it onto the male connector in the filter base in the “Engine” port. A “click” will be heard when properly connected.



FIGURE 15

AirDog® II-5G AIR/VAPOR RETURN LINE

- 6B-1. Remove the quick connect end of the fuel return line to the tank from the OE frame mounted fuel pump (figure 16).
- 6B-2. Remove the engine fuel return line quick connect fitting from the male connector located at the top front of the OE frame mounted fuel pump (figure 17). You will need the disconnect tool for this one.

**FIGURE 16**

DISCONNECT
HERE
AND
HERE

**FIGURE 17**

- 6B-3. Connect the previously disconnected female return line and the female tank line to the male connections on the return "T" (001-4B-1-0060) as illustrated in figure 18 below. (Note the bent section is facing toward the rear of the vehicle.)

**FIGURE 18**

NOTE: The OE fuel pump and fuel line from the fuel tank may be removed from the vehicle at this time, if desired.

AirDog®II-5G AIR/VAPOR RETURN LINE (CONTINUED)

6B-4. Assemble one end of the return line (Reference section 5) using Fuel line end FQC3890 and plug it into the “Return” J2044 fitting installed in the AirDog® (Figure 19). A “click” will be heard once the fitting is properly connected.

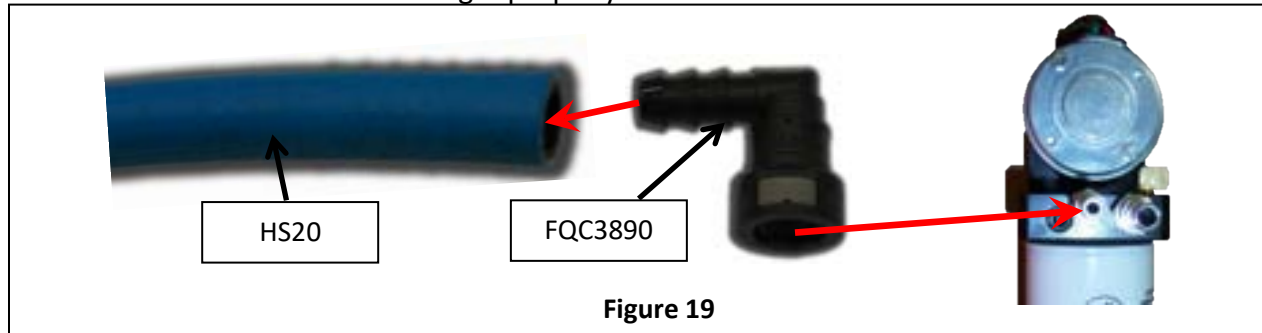

6B-5. Run the other end of the fuel line along the frame as described in step 5-3 to the remaining open end on the return tee. Cut the fuel line to length and insert fuel line end FQC38S per step 5-1. Once the connector is pressed in, install it on the return tee. A “click” will be heard once properly connected.

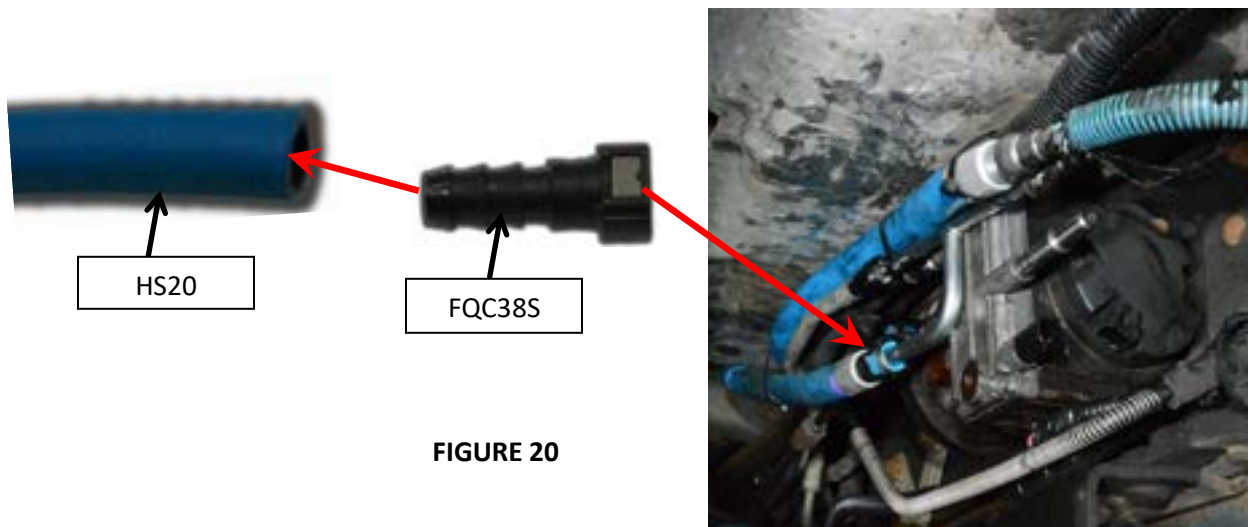

AirDog® II-5G FUEL SUCTION LINE

6C-1. Assemble one end of the fuel line (Reference section 5) using fuel line end FQC12S and connect it to the male J2044 connection that was previously installed in the “Fuel In” port in the Filter base. A “click” will be heard when properly connected.

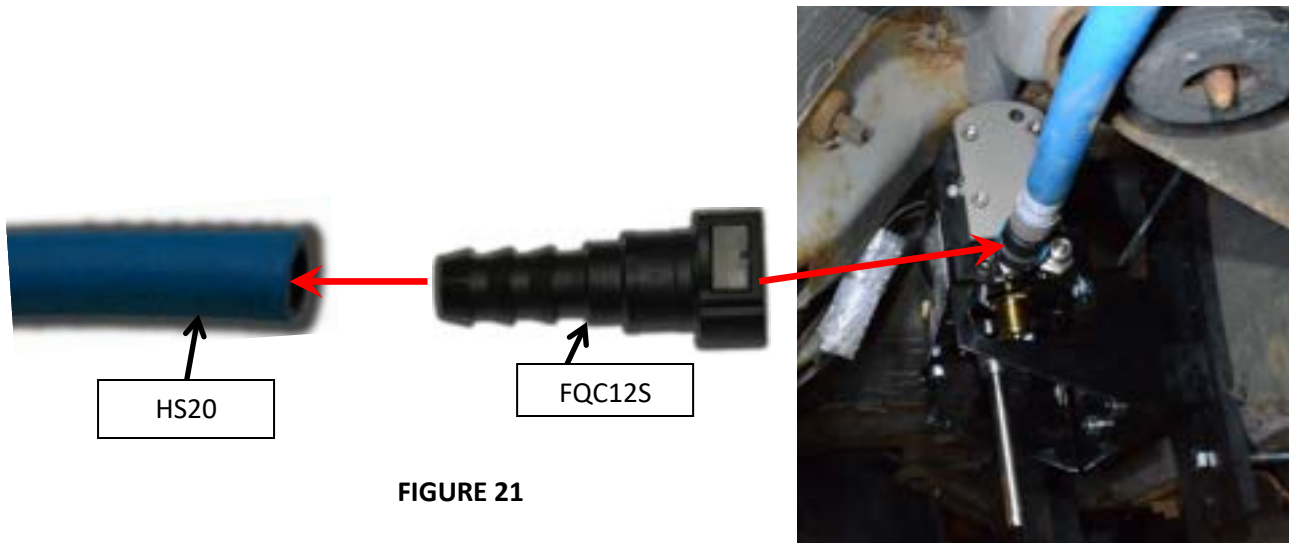
**FIGURE 21**

6C-2. Remove the original fuel suction line quick connect fitting (figure 22) from the top of the tank by squeezing the tabs on the end of the connector together while pulling. **DO NOT** mistake the return line with the suction line. Consult your factory manual if unsure of these procedures.

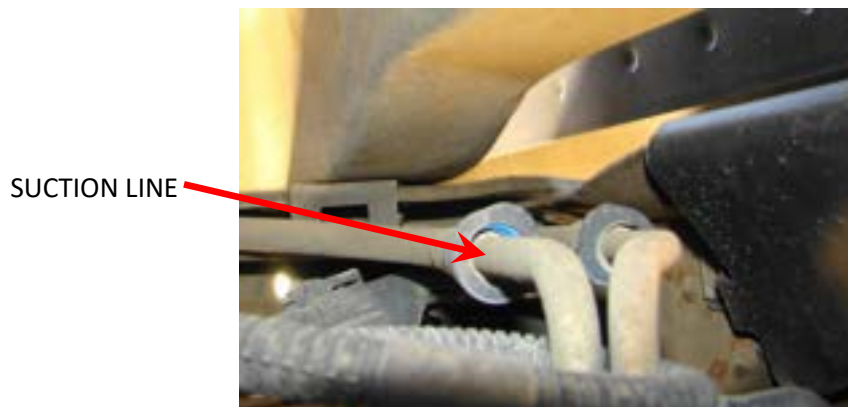
**FIGURE 22
IN MORE DETAIL**

To release the quick-connect fitting from the fuel tank suction tube, push the fitting toward the suction tube. With the plastic tabs firmly depressed, pull the fitting assembly from the suction tube. Hold the Quick Connect Fitting square to the suction tube. It may be difficult to disconnect the fitting it is cocked or becomes cocked during removal.

AirDog® II-5G FUEL SUCTION LINE (CONTINUED)

6C-3. Run the other end of the fuel line along the frame as mentioned in step 5-3 to the factory suction line coming out of the tank. Cut the fuel line to length and press in fuel line end FQC3890 per section 5. Once the connector is pressed in, connect it to the factory male suction line coming out of the tank. A “click” will be heard once properly connected.

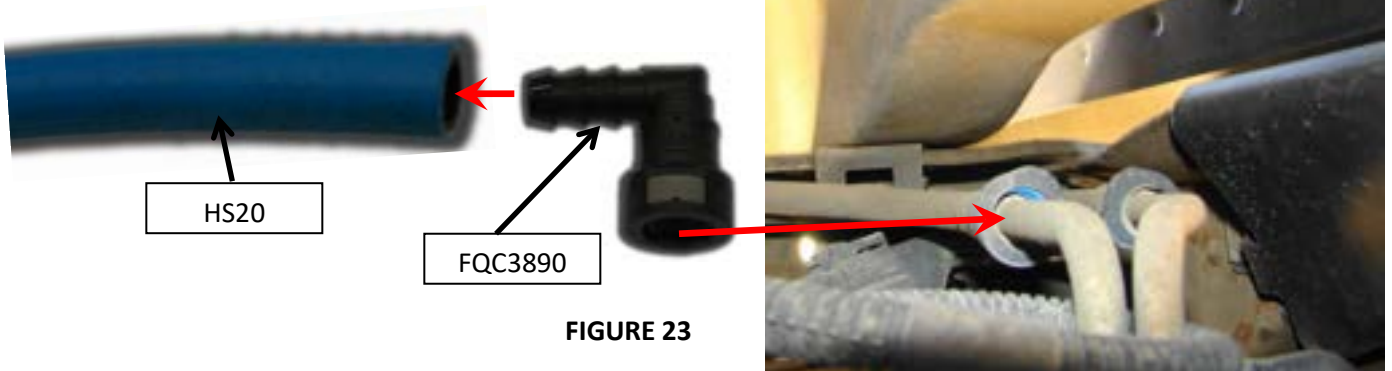

VERY IMPORTANT: Disconnect the power supply lead to the OE high pressure fuel pump located on the driver's side frame rail.



FIGURE 24

AirDog® II-5G WIRING HARNESS INSTALL

WIRING DIAGRAM

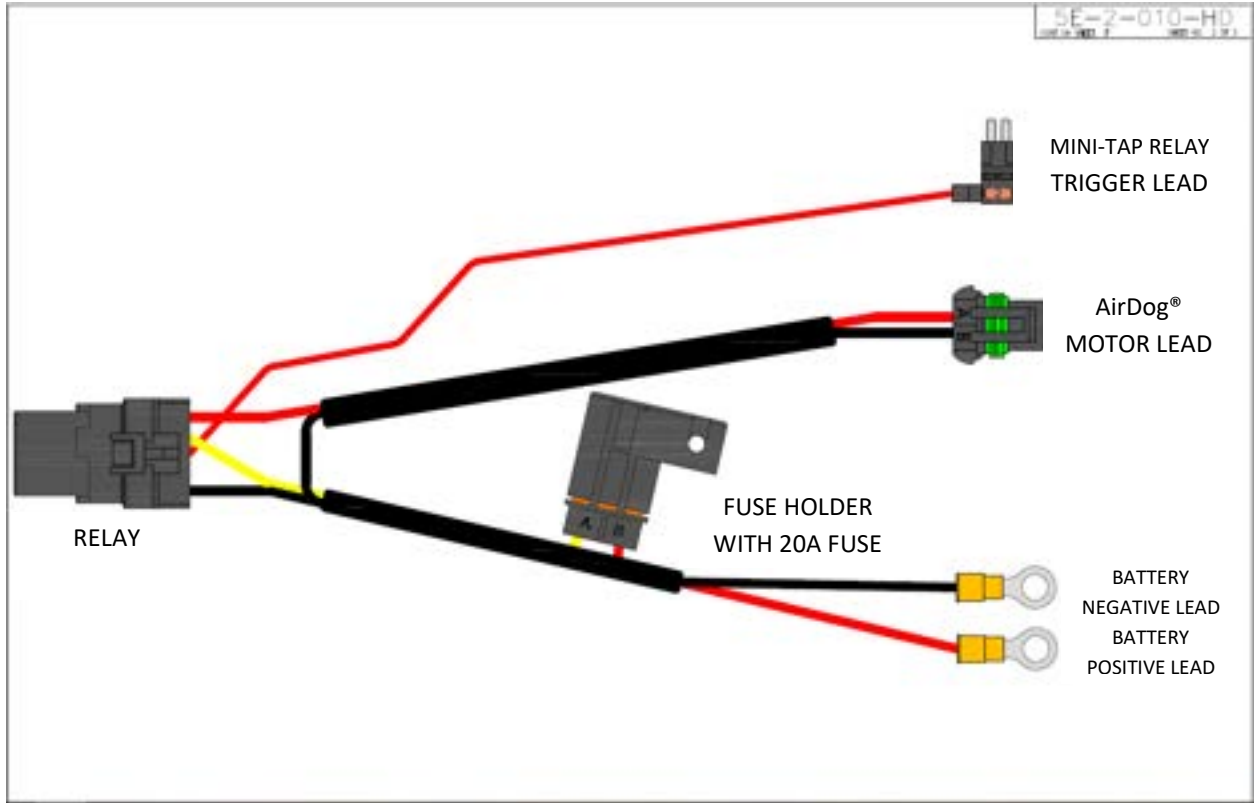

FIGURE 25

SECURE THE RELAY AND FUSE HOLDER TO THE VEHICLE

- 7-1. Secure the relay and fuse holder to the vehicle. Be sure to rout the wires away from any moving parts. The relay is illustrated below in figure 26. The fuse holder mounting is the same concept.



FIGURE 26

CONNECT THE AirDog® II-5G RELAY CONTROL LEAD

- 7-2. Route to Relay Lead to the fuse panel. Insert the mini fuse tap into a fuse on the panel that is "hot" when the starter key is turned to the on position. . If you are installing in a spot that is already in use, you will need to remove that fuse and install it into the fuse tap provided so both fuse spots are occupied. Or you may cut the fuse off and tap the wire into your factory fuel pump lead shown in figure 28.



FIGURE 27



FIGURE 28

NOTE: The power supply leads can be connected to the battery or the alternator. Connecting the power supply leads to the alternator instead of the battery will create a corrosion free connection.

- 7-3. Route the power supply leads to the alternator. Connect the Black (-) lead to the alternator *Ground* connection.

Connect the Red (+) lead to the alternator *Hot Lead* going to the battery.

OR

- 7-4. Should you choose to connect the power supply leads directly to the battery, connect the RED (+) lead to the POSITIVE (+) post of the driver's side battery. Connect the BLACK (-) lead to the NEGATIVE (-) post of the same battery.



FIGURE 29



FIGURE 30

- 7-5. Route the wiring harness to the **AirDog®** and connect the 2 pin connector to the corresponding connector on the **AirDog®**.



FIGURE 31

INITIAL START PROCEDURE

VERY IMPORTANT: Before starting the engine, be sure the power supply to the OE Fuel Pump, located on the driver's side frame rail has been disconnected from the Pump if the pump has not been previously removed!

- 8-1. The AirDog®II is a self-priming system, however, to prevent possible damage to the system, it is recommended to fill the pre-filter with diesel fuel before initial startup.
- 8-2. Rub diesel fuel or oil on the filter seals before installing to ensure a proper seal.
- 8-3. Turn the starter key to the on/run position.
- 8-4. While the AirDog®II is operating, bleed the fuel line to the engine of air by loosening the fuel line connection at the engine fitting. As soon as the line is purged of air and pure fuel is observed, properly tighten the fuel fitting. **NOTE: put a rag or shop towel over and around fitting to prevent splatter. Catch all spilled fuel and dispose of properly. Wear safety glasses.**
- 8-5. Start engine.

RECHECK ALL FUEL FITTINGS FOR LEAKAGE AND PROPERLY TORQUE. BE SURE ALL FUEL LINES ARE PROPERLY ROUTED TO PROTECT FROM EXCESSIVE HEAT AND SECURED TO PROTECT FROM CHAFFING AND ABRASION. RECHECK ALL ELECTRICAL LINES, SECURE AS NECESSARY.

CHECKING FOR EXCESSIVE PUMP NOISE

NOTE: Each AirDog®II has been manufactured in a Quality Controlled process and wet tested for operation and performance before shipment. This is a very quiet and smooth running system. With fuel or air alone, the AirDog®II fuel pump will run very quietly. However, if any fuel fitting on the vacuum side, between the fuel tank and the AirDog®II or the pre-filter has been left loose during the installation process, the system may be sucking air at an excessive rate and will be very noisy. Excessive restriction in the suction line from the fuel tank can cause vapor and noise, as well. To check for these problems, unscrew the pre-filter 3 or 4 full turns and activate the AirDog®II by turning the ignition switch to on. If the AirDog®II runs quietly, then excessive air from a loose fitting or leaking pre-filter seal or vapor from fuel flow restriction is most likely the reason for the excessive noise. Correct as necessary.

- A. The seal groove in the 3" filter is a snug fit and on occasion the seal has been found to not be fully seated. Remove the pre-filter, remove the seal from the top of the nut plate. Clean and lubricate the seal groove. Carefully replace the seal in the groove. Be sure to fully seat the seal.
- B. Check all fittings, especially the quick connect at the tank.

FILTER SERVICE RECOMMENDATIONS

Plugging of either the fuel filter or the water separator itself will cause low fuel pressure and low flow to the engine. If a low fuel pressure issue exists, replace the fuel filter. Typical fuel filter life is 15-20k miles depending on fuel quality.

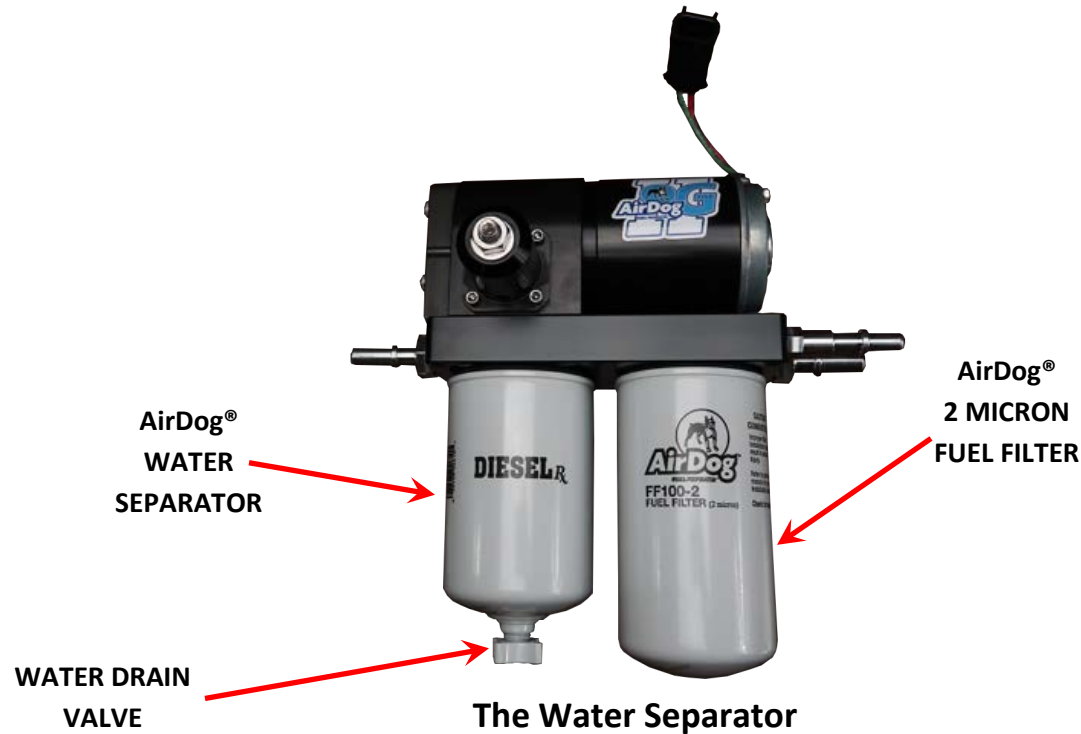

Replace the water separator every other time you change the Fuel Filter or if it becomes damaged or plugged. It is suggested to check/drain the water separator every three months or as needed should you experience excessive 'water in fuel' conditions. When installing the water separator, be sure to clean the underside of the AirDog® base. Follow the instructions printed on the pre-filter for proper tightening procedures.

CAUTION: Be extremely careful to prevent any contaminants or debris from entering the pre-filter when removing it for cleaning! Large debris will jam the Gerotor and cause the fuse to blow. This is not a warranty item. Should this happen, you can easily put the system back into working order. See the instructions on "How to clean the Gerotor" for proper procedures.

The Fuel Filter

Remove the fuel filter by turning it counter clockwise. **DO NOT** pre-fill the fuel filter with fuel. The AirDog® will fill the filter and prime the system automatically. Follow the instructions on the filter for proper tightening procedures.

CAUTION: Dispose of waste fuel and used filters properly to protect OUR environment.

CLEANING DEBRIS/CHECKING FOR DAMAGE IN/TO THE GEROTOR ASSEMBLY

STEP 1: Remove the four (4) socket head cap screws that secure the Gerotor cap using a 3/16 allen wrench.

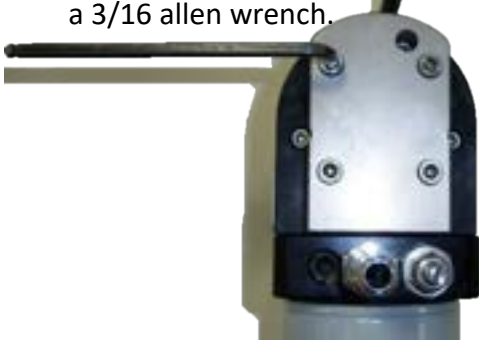

STEP 2: Carefully remove the O-rings you will need to reuse them.



STEP 3: Remove and clean the Gerotor. Be very careful to not damage the Gerotor.

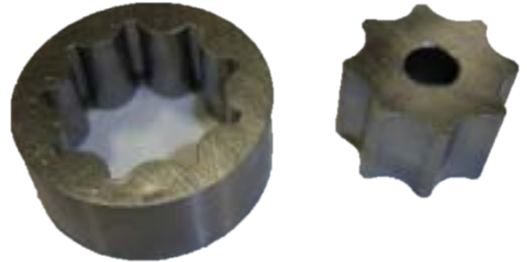

STEP 4: Remove the O-rings and clean/inspect the inside of the Gerotor pocket.



STEP 5: Reinstall the center gear.



STEP 6: Align and install the outer gear and O-rings.



STEP 7: Install the Gerotor Cap. Be very careful not to dislodge or pinch the O-rings.



STEP 8: Loose assemble the cap screws. Torque the cap screws in an opposing pattern.

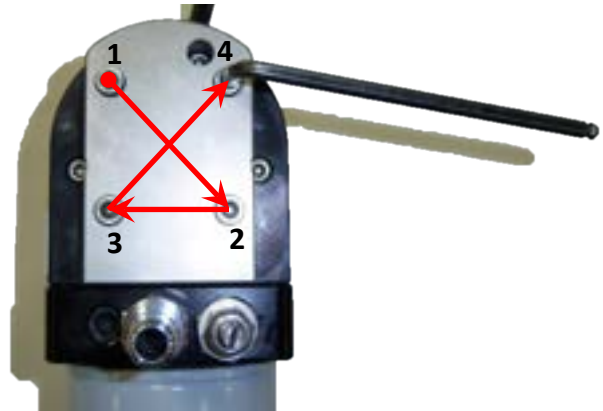

If there is damaged found to either the Gerotor, Gerotor pocket, or O-rings, call into AirDog® Tech Support for further assistance.

AirDog® II-5G ADJUSTABLE FUEL PRESSURE REGULATOR

The AirDog® II-5G rises to a new level of performance with an adjustable diaphragm fuel pressure regulator. This regulator offers more consistent fuel pressure and allows for higher flow rates at pressure. This regulator can also be boost compensated to battle any pressure drops under wide open throttle. The boost compensation kit is sold separately.

PRESSURE ADJUSTMENT FOR THE 6.0L POWERSTROKE

Loosen the Jam Nut with a 5/8 wrench

Re-torque after adjustment

Use a 3/16 allen to adjust the pressure

regulator

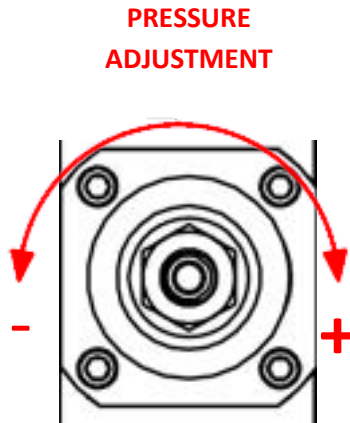

**PRE-SET AT 50-55PSI
FROM FACTORY**

Turn the adjuster screw counter-clockwise to reduce the output pressure or clockwise to increase the pressure. Be sure to re-torque the jam nut after adjusting the regulator. **IT IS STRONGLY RECOMMENDED TO ADJUST THE PRESSURE WHILE USING A FUEL PRESSURE GAUGE. TOO MUCH OR TOO LITTLE PRESSURE MAY CAUSE DAMAGE TO THE INJECTION SYSTEM!**

Every AirDog II-5G has a 90-degree brass fitting in the pump to where you can add a fuel pressure gauge or fuel pressure sending unit for an electric gauge.



PUREFLOW AIRDOG

LIFETIME LIMITED EXPRESS WARRANTY

FOR

Covered PureFlow AirDog® I, II, II-4G, II-5G and Raptor Systems

IMPORTANT NOTICE

TO ACTIVATE YOUR PUREFLOW AIRDOG WARRANTY, YOU MUST COMPLETE AND MAIL YOUR WARRANTY CARD TO PUREFLOW AIRDOG WITH A COPY OF YOUR ORIGINAL SALES RECEIPT WITHIN 30 DAYS OF PURCHASE. FAILURE TO COMPLETE AND SUBMIT YOUR WARRANTY CARD WILL RESULT IN A WARRANTY PERIOD OF THE COVERED PRODUCT TO ONE (1) YEAR FROM THE DATE OF PURCHASE.

PureFlow AirDog® (hereafter collectively, "SELLER") warrants and guarantees only to the Original Purchaser (hereafter collectively, BUYER) that All PureFlow AirDog® Systems (hereafter collectively, PRODUCT) shall be free from defects of materials and workmanship in the manufacturing process for as long as the BUYER owns the PRODUCT.

The Lifetime Limited Express Warranty is limited to the PRODUCT purchased by the original BUYER of the PRODUCT and limited solely to the parts contained within the PRODUCT and EXCLUDES ALL ELSE INCLUDING FILTERS AND WATER SEPARATORS. Any PRODUCT that is in question of Warranty must be returned, shipped prepaid, to PureFlow AirDog®. All Warranty claims are subject to the approval of PureFlow AirDog®. If it is determined that a Warranty claim exists, PureFlow AirDog® will, at its sole discretion, replace the defective PRODUCT with a comparable PRODUCT, repair the defective PRODUCT, or refund the BUYER'S purchase price in exchange for the PRODUCT. Repairs or replacements are warranted for only the remainder of the original warranty period and only to the original BUYER.

Under no circumstances shall the SELLER be liable for any labor charged or travel time incurred in the diagnosis for defects, removal, or reinstallation of the PRODUCT, or any contingent expense.

Under no circumstances will the SELLER be liable for any damage or expense incurred by reason of the use or sale of the PRODUCT.

Other than expressly set forth herein, the SELLER shall in no way be responsible for the proper or improper use and service of the PRODUCT. In no event shall the SELLER be liable for any special, incidental, indirect or consequential damages of any kind or nature, whether or not the BUYER of the PRODUCT was advised of the possibility of damage or harm, arising or resulting from the use or performance of the PRODUCT and BUYER hereby waives the right to any and all such claims.

BUYER, acknowledges that he/she is not relying on SELLER'S skill or judgment to select or furnish goods suitable for any particular purpose and that SELLER has no liability that will extend beyond the scope of the LIMITED EXPRESS WARRANTY contained herein, and BUYER hereby waives all remedies or liabilities, expressed or implied, arising by operation of law or otherwise.(including, without limitation, any obligation of SELLER with respect to fitness for any particular purpose; merchantability; and special, incidental, indirect or consequential damages) or whether or not occasioned by SELLER'S negligence.

SELLER disclaims any warranty and expressly disclaims any liability for personal injury or damages related to BUYER'S use of the PRODUCT. BUYER acknowledges and agrees that the disclaimer of any liability for personal injury is a material term for this agreement and BUYER agrees to indemnify SELLER and hold SELLER harmless from any claim related to the PRODUCT and its use or performance. Under no circumstances will SELLER be liable for any damages, liabilities, costs or expenses incurred as a result of or by reason of use, performance or sale of the PRODUCT, including without limitation, any damages, liabilities, costs or expenses incurred by reason of BUYER'S negligence related to those uses of the PRODUCT.

The proper installation of the PRODUCT is the sole responsibility of the BUYER. The SELLER assumes no liability regarding improper installation or misapplication of the PRODUCT.

SELLER hereby provides the following limited warranty as to description, quality, merchantability, fitness for the PRODUCT'S purpose, productiveness, or any other matter of SELLER'S PRODUCT sold herewith. The SELLER shall be in no way responsible for the open use and service of the PRODUCT and the BUYER hereby waives all rights other than those expressly written herein. This Warranty shall not be extended or varied except by a written instrument signed by SELLER and BUYER.

IN THE EVENT THAT THE BUYER DOES NOT AGREE WITH THIS AGREEMENT, THE BUYER MAY PROMPTLY RETURN THE PRODUCT, IN A NEW AND UNUSED CONDITION, WITH A DATED PROOF OF PURCHASE, TO THE PLACE OF PURCHASE WITHIN THIRTY (30) DAYS FROM THE DATE OF PURCHASE FOR A FULL REFUND. THE BUYER AGREES THAT THE INSTALLATION OF THIS PRODUCT CONFIRMS THE BUYER HAS READ AND UNDERSTANDS THIS AGREEMENT AND ACCEPTS THE TERMS AND CONDITIONS OF THIS AGREEMENT.

WARRANTY PROCEDURE

In the unlikely event a warranty appears as if it may be warranted, the following steps are taken:

- 1 The customer discussed the symptoms of the problem with a PureFlow AirDog® Technician. The customer is to have the system Serial Number and Model Number available for the Technician when the call is made. This will expedite all steps of the process.
- 2 The customer performs any and all tests requested by the PureFlow AirDog® Technician. This is done to isolate the potential problem while eliminating potential installation or maintenance related issues,
- 3 If the PureFlow AirDog® Technician determines based on the customer feedback concerning the requested testing that system may be at fault, the customer is advised that all returned pumps are tested upon arrival and should this returned pump perform at design criteria upon arrival, the customer will be charged a \$50.00 fee.
- 4 The PureFlow AirDog® Technician will first request the customer's phone number in the event the phone call is accidentally disconnected and then transfer the customer to a PureFlow AirDog® Customer Service Representative. Should a Customer Service Representative not be available, the Technician will offer the Customer the option to hold, call back, or receive a return call.
- 5 The PureFlow AirDog® Customer Service Representative will check to determine if the customer's Warranty Registration Card is on file.
 - a. If no Warranty Registration is found, the customer will be required to supply the original purchase receipt showing the purchase date.
 - b. If no Warranty Registration is found, the customer will be advised of the options should the system in question is out of the default warranty period (1 year).
- 6 The PureFlow AirDog® Customer Service Representative will request the customer information, including: Name, Address, Phone Number, Model Number, Serial Number, Year / Make / Model of vehicle, Name of Dealer purchased from, Purchase Date, Description of Problem, Customers' understanding of the resolution, and customer credit card information.
- 7 PureFlow AirDog® will cover Ground Shipping charges to ship the replacement unit and will include a prepaid shipping label for the return of the defective unit. Any additional items ordered at the time of the replacement shipment will include their portion of the shipping cost.
- 8 A period of 15 Calendar Days from the time of shipment is provided for the receipt of the defective unit at the PureFlow AirDog® facility. Failure to return ship the defective unit to arrive within the defined time period will result in a charge of \$250.00 against the customer's credit card as the purchase cost of the defective unit.