

#37



DF-100-5G

DF-165-5G

PATENT PROTECTED:

<https://pureflowairdog.com/p-35853-patents.html>

2011-2014 DURAMAX INSTALLATION INSTRUCTIONS

**PLEASE READ AND CHECK CONTENTS
BEFORE INSTALLATION**



**PUREFLOW AIRDOG
705 W MAUSOLEUM RD.
SHELBYVILLE, IN 46176**

**877-421-3187
PUREFLOWAIRDOG.COM**

TABLE OF CONTENTS

TITLE	PAGE
INTRODUCTION	2
SAFETY GUIDELINES	3
PRE-INSTALLATION CHECKS	4
PARTS LIST	5
QUICK CONNECT FITTING OVERVIEW	6
QUICK CONNECT FITTING ILLUSTRATION	7
PUMP FITTING INSTALLATION	8
MARKING AND DRILLING THE FRAME STANDOFF	9
PUMP TO CRADLE BRACKET INSTALLATION	10
PUMP TO FRAME STANDOFF INSTALLATION	11
FUEL LINE ASSEMBLY OVERVIEW	12
ENGINE LINE INSTALLATION	13
RETURN LINE INSTALLATION	15
INLET LINE INSTALLATION	16
WIRING INSTALLATION	17
INITIAL STARTING PROCEDURE	20
FILTER SERVICE	21
SERVICING THE PUMP GEROTOR	22
ADJUSTING FUEL PRESSURE	23
WARRANTY	24

INTRODUCTION

Thank you for choosing AirDog® for your truck fueling needs!

AirDog® recommends that a certified diesel shop technician install this product. Please note, if the end user performs the installation, it is recommended they have basic knowledge on how electric fuel systems operate and function. Failure to properly set up this fuel system may result in a voided warranty. **If properly set up per these instructions, the pump head carries a lifetime warranty to the original purchaser. THIS WARRANTY IS NON-TRANSFERRABLE!**

The AirDog® II-5G uses an adjustable diaphragm fuel pressure regulator to regulate the fuel pressure to the injection system. The pressure for this application is preset from the factory at 8-10psi. If a different pressure is desired, go to page 23 for instructions on how to adjust the pressure. **WARNING: RUNNING THE PUMP ABOVE 75PSI FOR THE DF-100 AND DF-165 WILL DECREASE THE LIFE OF THE PUMP SIGNIFICANTLY AND MAY VOID THE WARRANTY. MORE FUEL PRESSURE DOES NOT MEAN MORE FUEL FLOW AND TOO MUCH PRESSURE MAY DAMAGE YOUR INJECTION SYSTEM! MORE FUEL PRESSURE DOES NOT MEAN MORE FUEL FLOW!**

OVERVIEW ON HOW THE SYSTEM OPERATES

The AirDog® draws fuel from the tank from the factory suction line on the frame rail. The fuel is then pulled through a water separator before being pressurized through the Gerotor pump. The pressurized fuel is sent through the 2 micron fuel filter before being sent to the engine. The pump maintains pressure through a diaphragm fuel pressure regulator that recirculates fuel back through the water separator. The separated air from the diesel fuel is returned through a filler neck return tee.

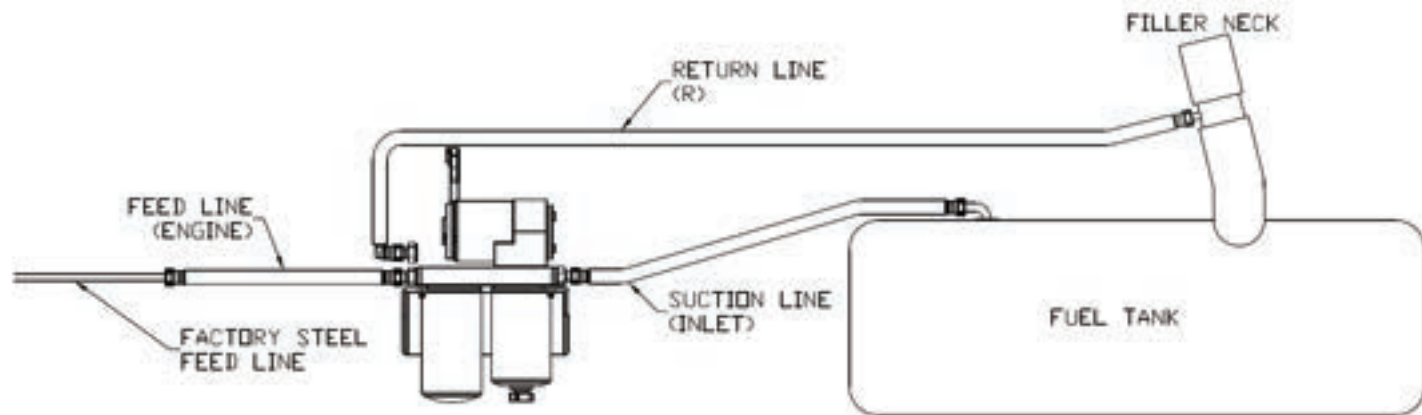

SAFETY GUIDELINES

IMPORTANT!

PLEASE READ THIS INSTALLATION MANUAL CAREFULLY

It contains important information, instructions, and necessary operating procedures. The continual observance of the operating procedures will help extend the life of the fuel system.



SAFETY INSTRUCTIONS

LEARN TO RECOGNIZE SAFETY INFORMATION

This is the safety alert symbol. When you see this symbol in this manual, **BE ALERT TO THE POTENTIAL FOR PERSONAL INJURY!**

Follow recommended precautions and safe operating practices.

UNDERSTANDING SIGNAL WORDS

A signal word-**DANGER**, **WARNING**, or **CAUTION** is used with the safety alert symbol.

DANGER indicates a hazardous situation which, if not avoided, **WILL** result in death or serious injury.

WARNING indicates a hazardous situation which if not avoided, **COULD** result in death or serious injury.

CAUTION indicates a hazardous situation which if not avoided, **COULD** result in minor or moderate injury

NOTICE indicates a preferred installation procedure.



PRE-INSTALLATION CHECKS



WARNING: SUFFOCATION HAZARD! Immediately discard any plastic bags and packing materials to eliminate **CHOKING HAZARDS TO CHILDREN AND ANIMALS.**

The installation of your AirDog® can be made relatively easy by following the steps outlined in this manual, and:

1. Inventory the package components completely. Notify PUREFLOW AIRDOG® immediately of any missing or damaged parts! 317-421-3180
2. Read the installation manual completely. Understand how the system operates and understand the installation recommendations before beginning the installation.
3. The installation recommendations contained herein are suggested installation guidelines only. Individual installations may vary.
4. If any installation procedure is uncertain, contact PUREFLOW® AIRDOG for technical assistance.
5. When installing the AirDog® fuel lines be sure to keep the **ORIGINAL ENGINE RETURN LINE** connected as it is from the factory!

SAFETY GUIDELINES!



WARNING

Please be sure to check the vehicle's tires to prevent rolling



WARNING

Please use proper supports when working beneath an elevated vehicle



CAUTION

Most diesel pickups have two (2) 12 volt batteries. Disconnect the battery cables to both batteries before proceeding with the AirDog® installation



WARNING

Vehicle main frametrails should not be drilled into or welded upon.



CAUTION

Wear safety glasses or shield when using tools such as drills and grinders or when using a punch or chisel



CAUTION











Prolonged exposure to loud noise can cause impairment or loss of hearing. Wear suitable hearing protective devices such as ear muffs or ear plugs to protect against loud noises.



CAUTION

Use common sense when routing fuel lines and electrical wiring. Keep them away from hot exhaust components and/or moving parts. Properly secure lines to prevent chaffing.

PARTS LIST

QTY	DESCRIPTION	PART NUMBER	IMAGE
1	AirDog®	DF-100 OR DF-165	
1	AirDog® Cradle Bracket	001-3C-0004	
1	Mounting Bracket Hardware	901-61-0102-PM-C-12	
1	Wiring Harness	5E-2-010-HD	
1	1.5" Filler Neck Tee with Clamps	001-4A-1-0150	
1	20ft of Fuel Line	HS20	
1	1/2" Straight Hose Quick Connect Fitting	FQC12S	
1	3/8" 90deg Hose Quick Connect Fitting	FQC3890	
1	12mm Straight Hose Quick Connect Fitting	FQC118S	
3	1/2" 90 deg Hose Quick Connect Fitting	FQC1290	
2	1/2" Male Quick Connect x 3/4-16 UNF ORB	08J2044-3/4UNF	
1	3/8" Male SAE J2044 Quick Connect x 7/16 ORB	06J2044716UNF	
1	Zip/Cable Tie Bundle	5H-2-1-B	
1	Customer Service O-ring Kit	901-05-0500	

WHY WE USE QUICK CONNECT FITTINGS

Almost every modern vehicle on the road uses what are called quick connect fittings for their fuel system. These are standardized using J2044 SAE specifications. We use these fittings to make the installation of our fuel systems as simple and as least invasive as possible. This allows for a simple/clean installation of our products.

HOW THE CONNECTIONS WORK

To connect the assemblies, simply insert the male end form into the mating female connector. Push firmly until you hear it “click” into place. To disconnect the fittings, press down and hold the tabs on the female connector while you firmly pull the assembly apart.



ILLUSTRATION OF QUICK CONNECT COMPONENTS

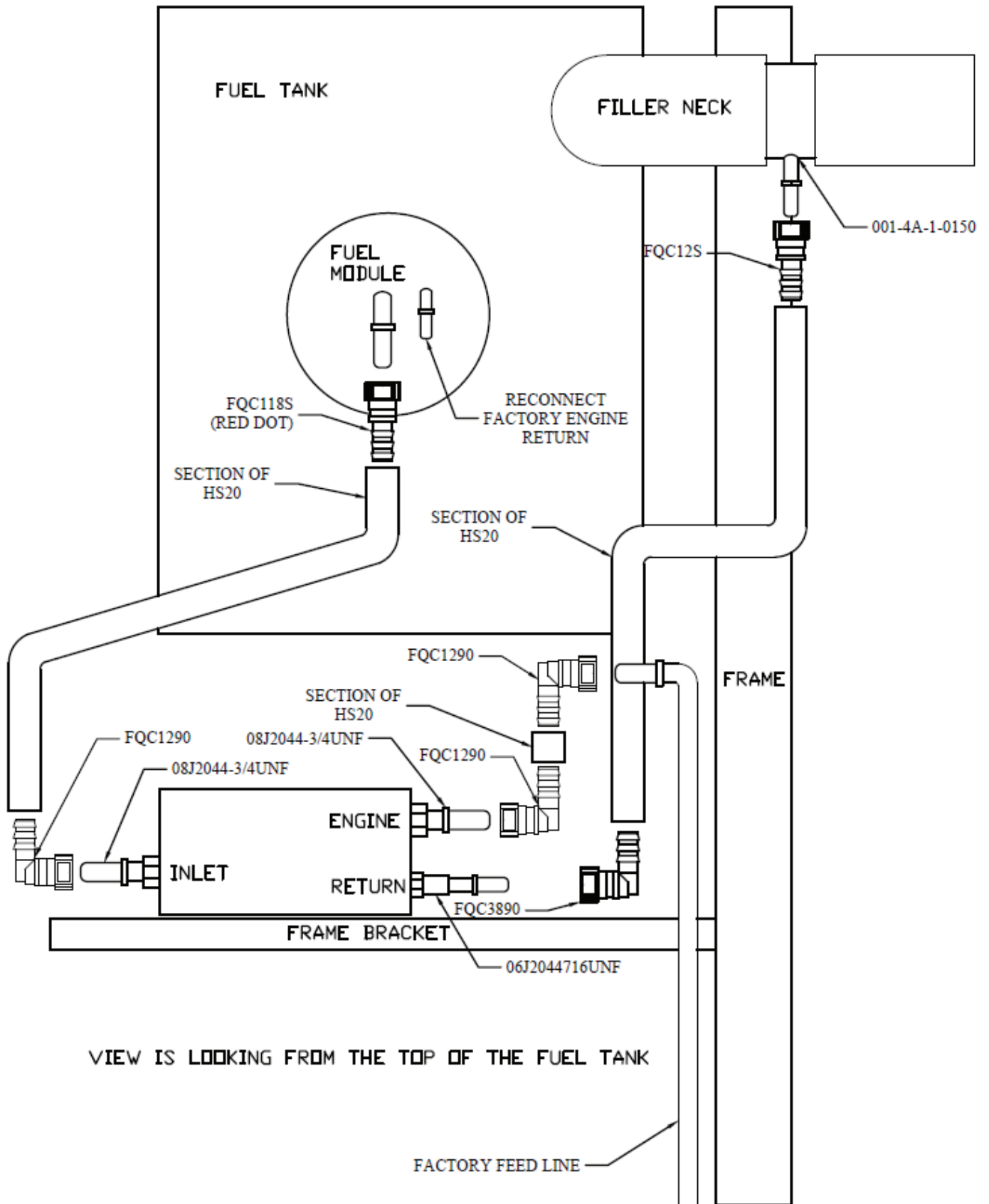

INSTALLING THE PUMP FITTINGS

TOOLS NEEDED:

- Torque Wrench
- 7/8" Deep Socket
- 9/16" Deep Socket

PARTS NEEDED:

- (2) 08J2044-3/4UNF Fittings
- (1) 06J2044716UNF Fitting

- 1-1. Dip the threaded end of the 08J2044-3/4UNF fitting into clean motor oil and hand-thread into the "ENGINE" and "INLET" ports of the AirDog®II-5G filter base as illustrated in figures 1, 2, and 3. Using a 7/8" deep socket, torque the fittings to 180in-lb or 15ft-lb.
- 1-2. Dip the threaded end of the 06J2044716UNF fitting into clean motor oil and hand-thread into the "RETURN" port of the the AirDog®II-5G filter base as illustrated in figures 1 and 2. Using a 9/16" deep socket, torque the fitting to 84in-lb or 7ft-lb.

NOTICE

DO NOT overtighten the fittings or damage may occur!

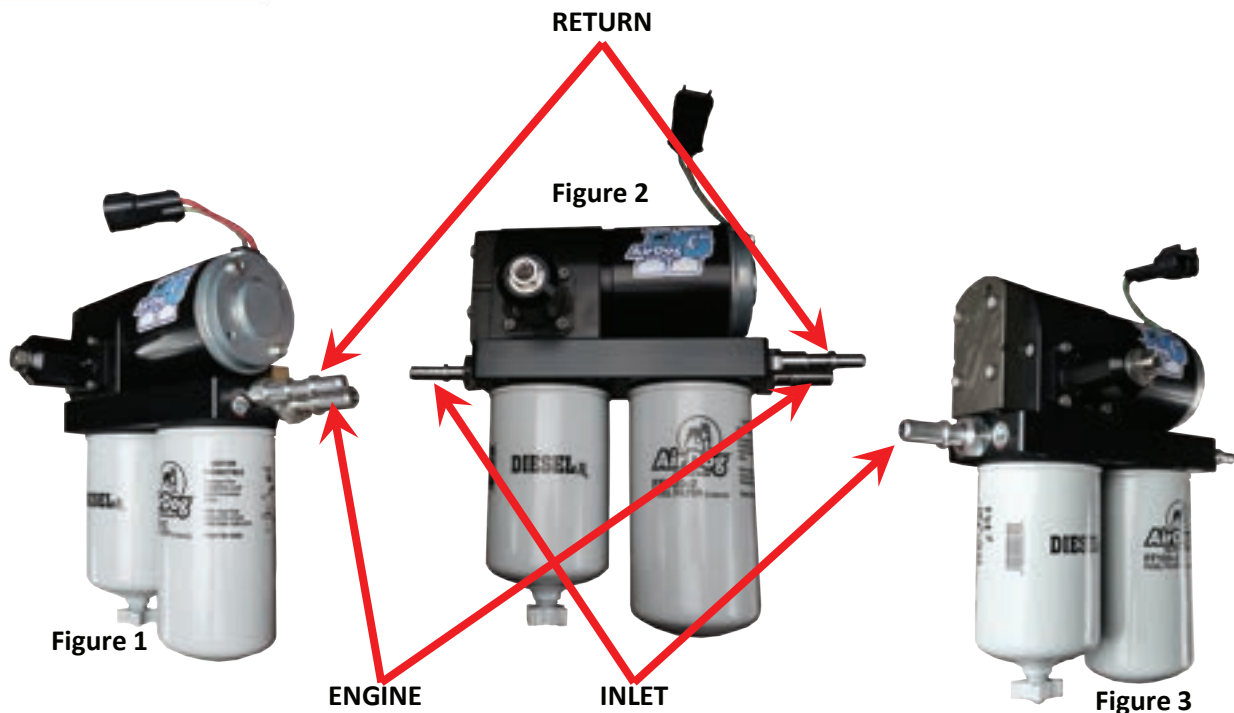

MARKING AND DRILLING THE FRAME STANDOFF

TOOLS NEEDED:

- Permanent Marker
- Cordless Drill
- Pilot Drill Bit
- 5/16" Drill Bit

PARTS NEEDED:

- (1) 001-3C-0004 Cradle Bracket
- (1) AirDog Pump Assembly

- 2-1. Using the formed mounting bracket (001-3C-0004), hold it up to the frame stand off and use it to mark where to drill the holes. Make sure the pump clears the bottom of the cab and keep in mind to give plenty of clearance to keep fittings and fuel line away from the frame and the driveshaft. We aligned the bottom left hole with the left slot in the frame standoff.



Figure 4



Figure 5

- 2-2. Using a small drill bit as a pilot bit, drill the holes marked in step 6-4. Once those holes are drilled, step the bit up to a 5/16" bit and drill the holes. Be sure not to puncture the fuel tank when drilling.



Figure 6



Figure 7

INSTALLING THE PUMP ON THE CRADLE BRACKET

TOOLS NEEDED:

- 3/16 Allen
- 7/16 Socket or Wrench

PARTS NEEDED:

- (4) 1/4-20 x 1.25 Socket Head Cap Screws
- (4) 1/4" Lock Washers
- (4) 1/4-20 Nuts
- (1) 001-3C-0004 Cradle Bracket

- 3-1. Using the above listed hardware, mount the AirDog to the cradle bracket in the desired orientation using a 7/16 socket and 3/16 Allen wrench.

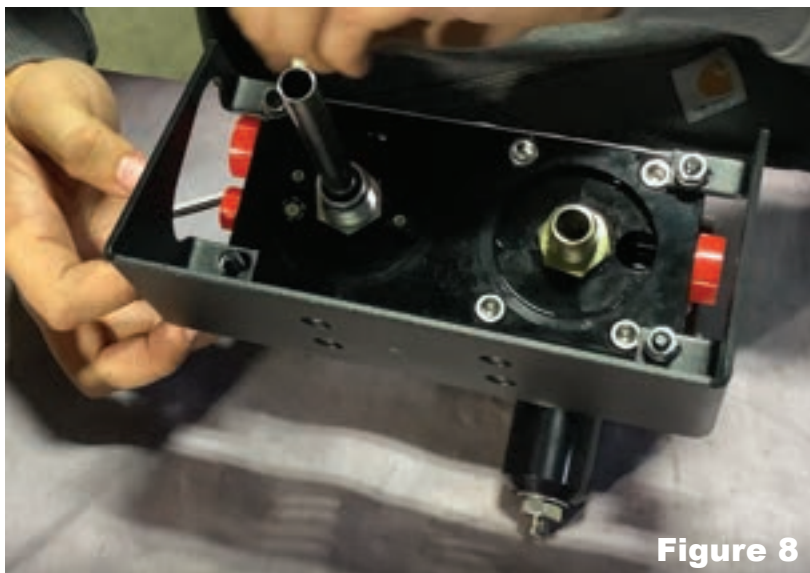

INSTALLING THE PUMP ON THE FRAME STANDOFF

TOOLS NEEDED:

- 1/4" Allen
- 1/2" Socket or Wrench

PARTS NEEDED:

- (4) 5/16-18 x 0.75" Socket Head Cap Screws
- (4) 5/16" Lock Washers
- (4) 5/16-18 Nuts

- 4-1. Using a 1/4" allen wrench or driver and a 1/2" wrench or socket, install the 5/16 hardware to mount the pump/bracket assembly to the frame standoff. For the pump to fit, you will need to point the regulator towards the front of the truck (Figure 11)



Figure 10 Regulator



Figure 11

FUEL LINE ASSEMBLY OVERVIEW

This kit includes a length of fuel line and separate fuel line fittings to allow for a much cleaner looking installation. Assemble the fuel lines as you install them.

NOTICE

Do not pre-assemble the fuel lines, or the lengths will not be correct.

- 5-1. Take the fuel line end and lubricate the barbed end with clean motor oil (Figure 12) and press it into the fuel line (HS20) until all of the barbs are covered and the fuel line contacts the shoulder (Figures 13 and 14). The fuel line end should look like Figure 14.



Figure 12



Figure 13



Figure 14

- 5-2. Now plug that fuel line with that fitting into the connection on either the AirDog® or the truck where the manual calls it out.
- 5-3. Run the fuel line along the frame away from any hot or moving parts such as exhaust or the driveshaft (Figure 15). Cut the hose to length and insert the other fuel line end that the manual calls out into the fuel line as outlined in step 5-1.

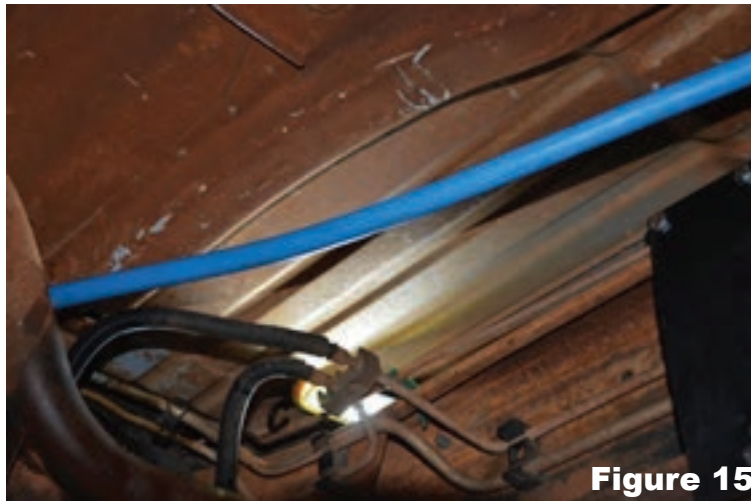

Figure 15

NOTICE

Hose clamps are not needed for these push-lock connectors. They may cause damage to the hose and cause fuel leaks.

ENGINE LINE INSTALLATION

TOOLS NEEDED:

- 1/2" Fuel Line Disconnect Tool
- Clean Motor Oil or ATF
- Hose Cutters or a way to cut Fuel Line
- 17mm Wrench

PARTS NEEDED:

- (2) FQC1290
- (1) HS20 20ft Fuel Line

To install the AirDog® fuel supply line to the engine, you must first remove the (flexible) factory fuel line connecting the fuel tank to the frame mounted steel fuel line (Figure 19). It will be the larger of the two lines that are on the frame.

NOTICE

The fuel tank connections are located behind the tank shield. It may be necessary to remove or bend the tank shield down to access the suction tube quick connect fitting.

- 6-1. Remove the factory fuel supply line from the fuel tank suction tube. Place the 1/2" fuel line disconnect tool around the fuel line and press into the Quick Connect fitting to release the locks. Carefully pull the factory quick connect fitting and fuel line from the fuel tank suction fitting.



Figure 16

The DISCONNECT TOOL (as seen below) can be purchased from your local auto parts store. **This tool is NOT included in the kit.**



Figure 17

ENGINE LINE INSTALLATION CONTINUED

- 6-2. Disconnect the other end of the fuel supply line from the steel line using the disconnect tool. It is the larger of the two lines on the frame. This connection is located between the frame bracket and the front of the fuel tank. You may now remove the 18" of factory flex line.

Figure 18



Figure 19



- 6-3. Assemble one end of the hose (Reference section 5) using fuel line end FCQ1290 and plug it into the J2044 male connection on the factory fuel line to where the factory suction line was just removed from behind the fuel cooler in the previous step. A "click" will be heard once properly connected.

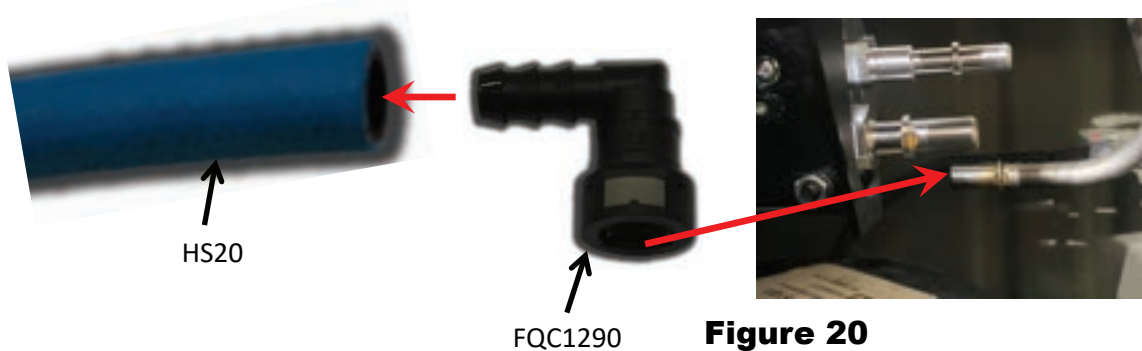

Figure 20

- 6-4. Run the fuel line along the frame as mentioned in step 5-3 to the "Engine" port in the AirDog®. Cut the fuel line to length and insert fuel line end FCQ1290 per step 5-1. Once the connector is installed, connect it to the male J2044 fitting in the "Engine" port in the AirDog®. A "click" will be heard once properly connected.



Figure 21

RETURN LINE INSTALLATION

TOOLS NEEDED:

- Clean Motor Oil or ATF
- Hose Cutters or a way to cut Fuel Line and the Filler Neck

PARTS NEEDED:

- (1) 001-4A-1-0150 1.5" Filler Neck Return Tee with Clamps
- (1) FQC3890 3/8" 90deg Quick Connect Fitting
- (1) FQC12S 1/2" Straight Quick Connect Fitting
- (1) HS20 20ft Fuel Line

- 7-1. Cut the filler tube as illustrated in figure 22. Loosen assemble clamps on each end of filler tube before the return tee (001-4A-1-0150) is pushed in. Install the filler return tee with the arrows pointing towards the fuel tank (figure 23). Failure to do so will cause fuel to spray up the filler tube and not down it. The finished product should look like figure 24.

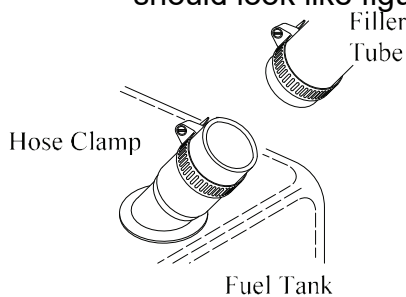

Figure 22



Figure 23



Figure 24

- 7-2. Assemble one end of the hose (Reference section 5) using Fuel line end FQC1290 and plug it into the "Return" J2044 fitting installed in the AirDog® (Figure 25). A "click" will be heard once the fitting is properly connected.

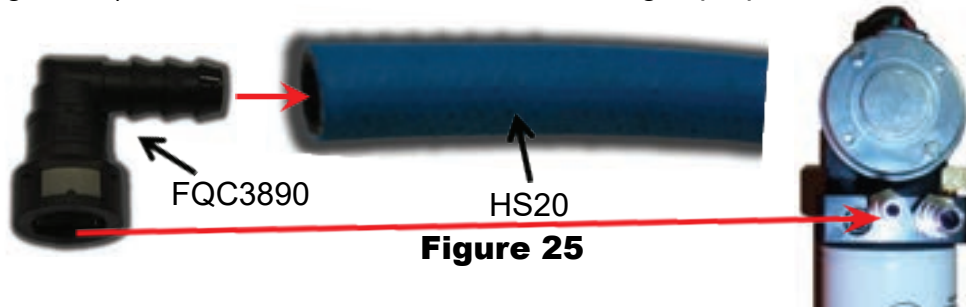

Figure 25

- 7-3. Run the fuel line along the frame as mentioned in step 4-3 to the filler neck tee. Cut the fuel line to length and insert fuel line end FQC12S per step 5-1. Once the connector is installed, connect it to the male J2044 fitting in the filler neck tee (001-4A-1-0150). A "click" will be heard once properly connected.



Figure 26

INLET LINE INSTALLATION

TOOLS NEEDED:

- Clean Motor Oil or ATF
- Hose Cutters or a way to cut Fuel Line and the Filler Neck

PARTS NEEDED:

- (1) FQC1290 1/2" 90deg Quick Connect Fitting
- (1) FQC118S 11.8mm Straight Quick Connect Fitting
- (1) HS20 20ft Fuel Line

- 8-1. Assemble one end of the hose (Reference section 5) using fuel line end FCQ1290 and plug it into the J2044 male connection in the AirDog® labeled "INLET." A "click" will be heard once properly connected.

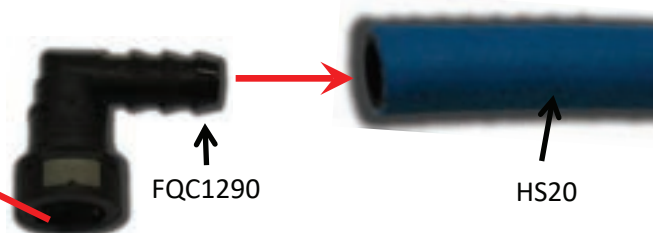

Figure 27

- 8-2. Assemble one end of the hose (Reference section 5) using fuel line end FCQ118S and plug it into the male connection to where the factory suction line was just removed in step 5-2. A "click" will be heard once properly connected.

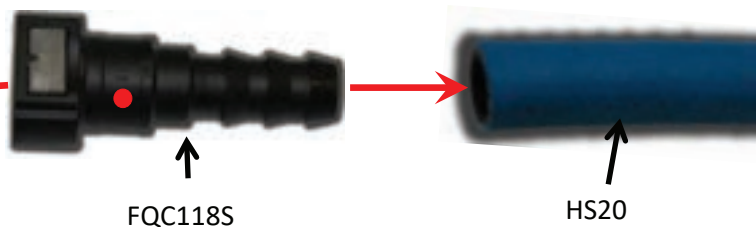

Figure 28

NOTICE

VERY IMPORTANT TO PREVENT FUEL LEAKS! Be sure NOT to use one of the FQC12S fittings in place of the FQC118S! They are similar in size and shape. The one that needs to be used is 11.8mm and is identified by a red dot and is labeled 11.8 (Figure 29).

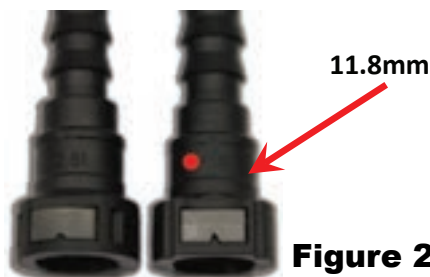

Figure 29

WIRING INSTALLATION

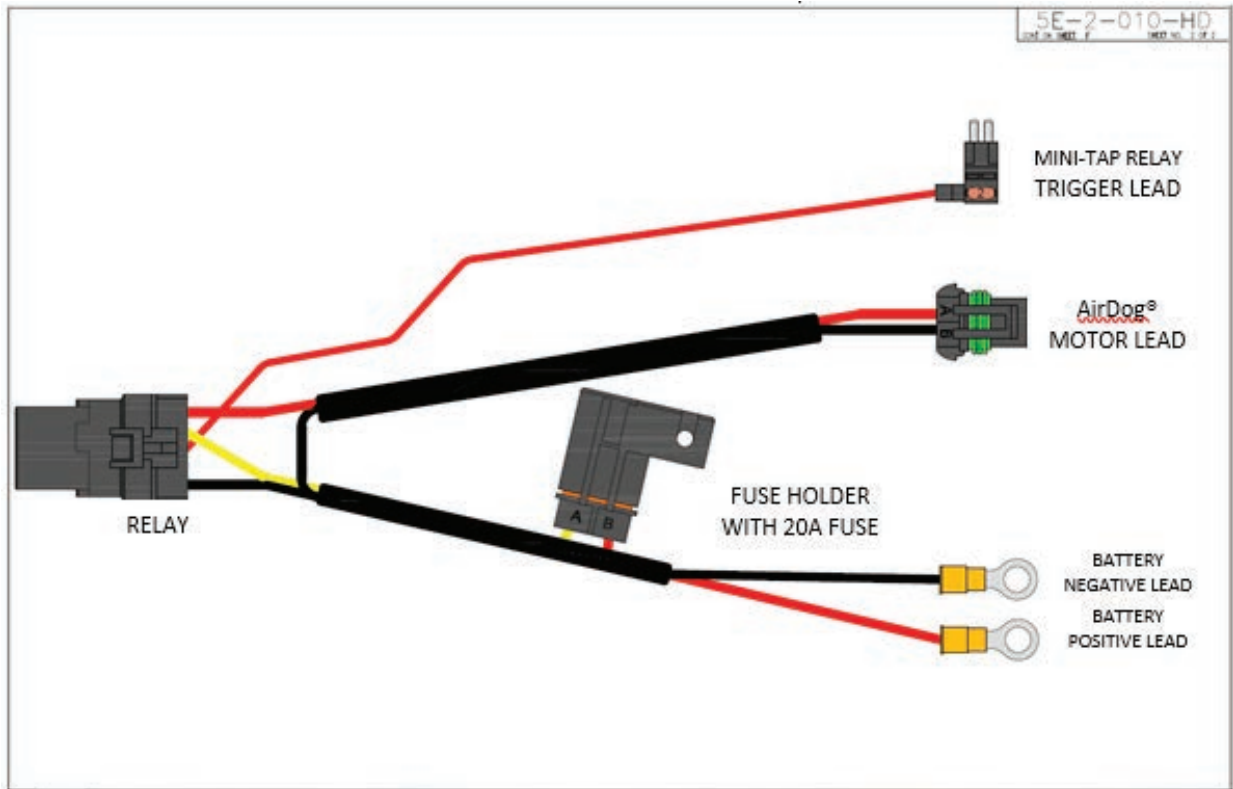

Figure 30

- 9-1. Secure the relay and fuse holder to the vehicle. Be sure to route the wires away from any moving parts. The relay is illustrated below in figure 31. The fuse holder mounting is the same concept.



Figure 31

WIRING INSTALLATION CONTINUED

- 9-2. Remove the plastic housing (skirt) around the fuse box. On some models it may be necessary to remove the fender/cowl brace to allow access to the fuse box
- 9-3. After accessing the fuse panel, use a test light or voltmeter to find a fuse terminal that is HOT only when the ignition is in the on position. Connect the 'Red' Relay Trigger wire with the mini fuse tap to that terminal. Be sure to install the fuse that is removed back into the fuse tap we supply, once installed into the fuse box the fuse tap should have both fuse spots filled. TBC Batt, Ign 1 or 2, Acc and HVAC are commonly used to supply power.



Figure 32

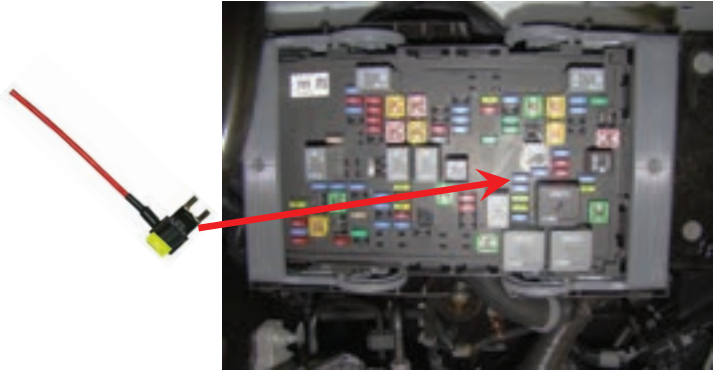

Figure 33

NOTICE

Connecting the power supply leads to the alternator instead of the battery will create a corrosion resistant connection.

- 9-4a. Route the Red and Black power supply leads to the alternator. Connect the Black (-) lead to the alternator Chassis Ground connection. Connect the Red (+) lead to the alternator Hot Lead going to the battery.

Black (-) Red (+)



Figure 34

WIRING INSTALLATION CONTINUED

- 9-4b. Should you choose to connect the power supply leads directly to the battery, connect the Red (+) led to the Positive (+) post of the driver's side battery. Connect the Black (-) lead to the Negative (-) post of the same battery.

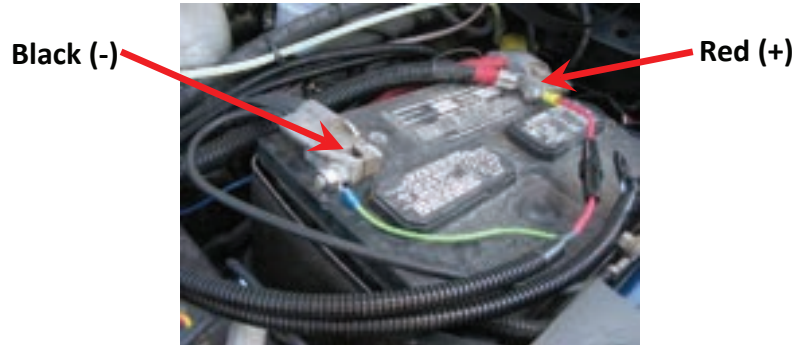

Figure 35

- 9-5. Route the wiring harness to the AirDog® and connect the 2 pin Metri-Pack connector to the corresponding connector on the AirDog®.

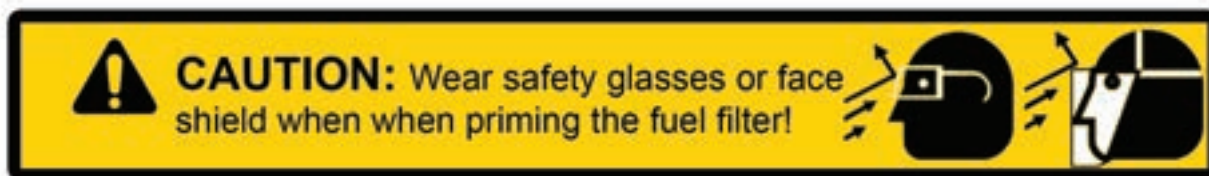

Figure 36

INITIAL STARTING PROCEDURE

The AirDog® is a self-priming system, however, to prevent potential damage to the system, it is recommended to fill the pre-filter with diesel fuel before initial startup.

- 10-1. Fill the water separator with clean diesel fuel.
- 10-2. Turn the starter key to the on/run position.
- 10-3. While the AirDog® is operating, bleed the air from the fuel line to the engine by loosening the fuel line connection at the engine fitting. As soon as the line is purged of air and pure fuel is observed, properly tighten the fuel fitting.



NOTE: put a rag or shop towel over and around fitting to prevent splatter. Catch all spilled fuel and dispose of properly.

- 10-4. Start the engine!

RECHECK ALL FUEL FITTINGS FOR LEAKAGE AND PROPERLY TORQUE. BE SURE ALL FUEL LINES ARE PROPERLY ROUTED TO PROTECT FROM EXCESSIVE HEAT AND SECURED TO PROTECT FROM CHAFFING AND ABRASION. RECHECK ALL ELECTRICAL LINES, SECURE AS NECESSARY.

Checking Pump Noise!

NOTE: Each AirDog® has been manufactured in a Quality Controlled process and fully tested for operation and performance before shipment. This is a smooth running system. However, if any fuel fitting on the vacuum side, between the fuel tank and the AirDog® or the pre-filter, has been left loose during the installation process, the system may suck air at an excessive rate and will be very noisy. To check for this problem, unscrew the pre-filter 3 or 4 full turns and activate the AirDog® by turning the ignition switch to on. If the AirDog® runs quietly, then excessive air from a loose fitting or leaking pre-filter seal is most likely the reason for the excessive noise. Correct as necessary.

- A. The seal groove in the pre-filter is a snug fit and on occasion the seal has been found to not be fully seated. Remove the pre-filter, remove the seal from the top of the nut plate. Clean and lubricate the seal groove. Carefully replace the seal in the groove. Be sure to fully seat the seal.
- B. Check the fittings, especially the quick connect at the tank.

FILTER SERVICE RECOMMENDATIONS

Plugging of either the fuel filter or the water separator itself will cause low fuel pressure and low flow to the engine. If a low fuel pressure issue exists, replace the fuel filter. Typical fuel filter life is 15-20k miles depending on fuel quality.



Replace the water separator every other time you change the Fuel Filter or if it becomes damaged or plugged. It is suggested to check/drain the water separator every three months or as needed should you experience excessive 'water in fuel' conditions. When installing the water separator, be sure to clean the underside of the AirDog® base. Follow the instructions printed on the pre-filter for proper tightening procedures.

NOTE: Be extremely careful to prevent any contaminants or debris from entering the pre-filter when removing it for cleaning! Large debris will jam the Gerotor and cause the fuse to blow. This is not a warranty item. Should this happen, you can easily put the system back into working order. See the instructions on "How to clean the Gerotor" for proper procedures.

The Fuel Filter

Remove the fuel filter by turning it counter clockwise. Do not pre-fill the fuel filter with fuel. The AirDog® will fill the filter and prime the system automatically. Follow the instructions on the filter for proper tightening procedures.

NOTE: Dispose of waste fuel and used filters properly to protect OUR environment!

SERVICING THE PUMP GEROTOR

CLEANING DEBRIS/CHECKING FOR DAMAGE INTO THE GEROTOR ASSEMBLY

STEP 1: Remove the four (4) socket head cap screws that secure the Gerotor cap using a 3/16 allen wrench.

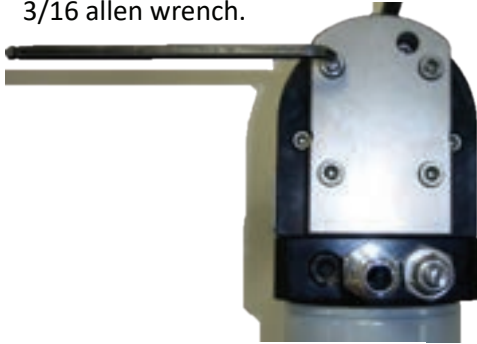

STEP 2: Carefully remove the O-rings you will need to reuse them.



STEP 3: Remove and clean the Gerotor. Be very careful to not damage the Gerotor.

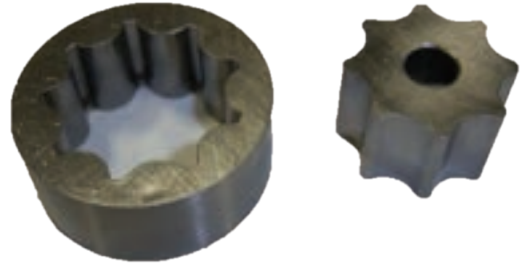

STEP 4: Remove the O-rings and clean/inspect the inside of the Gerotor pocket.

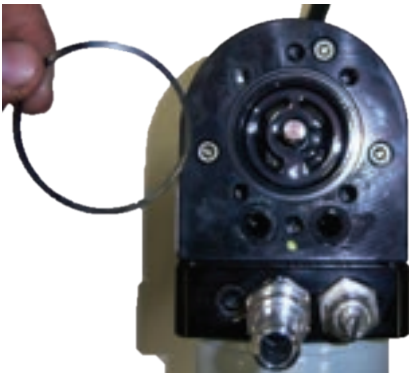

STEP 5: Reinstall the center gear.



STEP 6: Align and install the outer gear and O-rings.



STEP 7: Install the Gerotor Cap. Be very careful not to dislodge or pinch the O-rings.



STEP 8: Loosen the cap screws. Torque the cap screws in an opposing pattern.

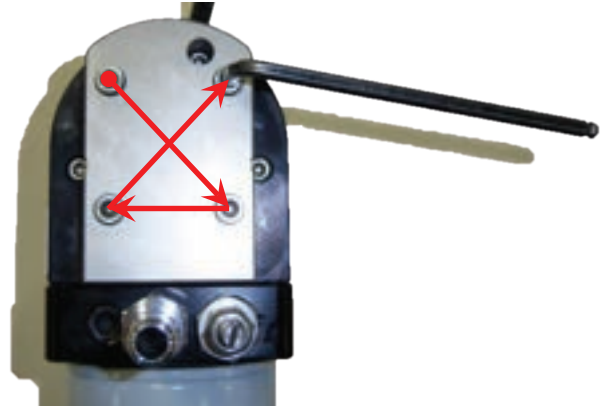

If there is damaged found to either the Gerotor, Gerotor pocket, or O-rings, call into AirDog® Tech Support for further assistance.

ADJUSTING FUEL PRESSURE

AirDog®II-5G ADJUSTABLE FUEL PRESSURE REGULATOR

The AirDog®II-5G rises to a new level of performance with an adjustable diaphragm fuel pressure regulator. This regulator offers more consistent fuel pressure and allows for higher flow rates at pressure. This regulator can also be boost compensated to battle any pressure drops under wide open throttle. The boost compensation kit is sold separately.

PRESSURE ADJUSTMENT FOR THE 6.6L DURAMAX



PRESSURE
ADJUSTMENT

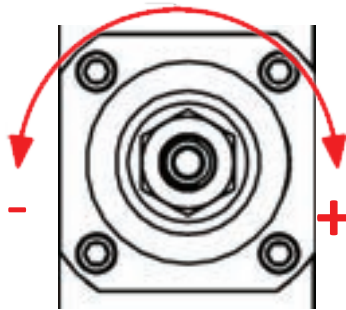

PRE-SET AT 8-10 PSI
FROM FACTORY

Turn the adjuster screw counter-clockwise to reduce the output pressure or clockwise to increase the pressure. Be sure to re-torque the jam nut after adjusting the regulator. IT IS STRONGLY RECOMMENDED TO ADJUST THE PRESSURE WHILE USING A FUEL PRESSURE GAUGE. TOO MUCH OR TOO LITTLE PRESSURE MAY CAUSE DAMAGE TO THE INJECTION SYSTEM!

Every AirDog II-5G has a 90-degree brass fitting in the pump to where you can add a fuel pressure gauge or fuel pressure sending unit for an electric gauge.



WARRANTY

PUREFLOW AIRDOG LIFETIME LIMITED EXPRESS WARRANTY FOR Covered PureFlow AirDog I, II and Raptor Systems

IMPORTANT NOTICE

TO ACTIVATE YOUR PUREFLOW AIRDOG WARRANTY, YOU MUST COMPLETE AND MAIL YOUR WARRANTY CARD TO PUREFLOW AIRDOG WITH A COPY OF YOUR ORIGINAL SALES RECEIPT WITHIN 30 DAYS OF PURCHASE. FAILURE TO COMPLETE AND SUBMIT YOUR WARRANTY CARD WILL RESULT IN A WARRANTY PERIOD OF THE COVERED PRODUCT TO ONE (1) YEAR FROM THE DATE OF PURCHASE.

PureFlow AirDog (hereafter collectively, "SELLER") warrants and guarantees only to the Original Purchaser (hereafter collectively, BUYER) that All PureFlow AirDog Systems (hereafter collectively, PRODUCT) shall be free from defects of materials and workmanship in the manufacturing process for as long as the BUYER owns the PRODUCT.

The Lifetime Limited Express Warranty is limited to the PRODUCT purchased by the original BUYER of the PRODUCT and limited solely to the parts contained within the PRODUCT and EXCLUDES ALL ELSE INCLUDING FILTERS AND WATER SEPARATORS. Any PRODUCT that is in question of Warranty must be returned, shipped prepaid, to PureFlow AirDog. All Warranty claims are subject to the approval of PureFlow AirDog. If it is determined that a Warranty claim exists, PureFlow AirDog will, at its sole discretion, replace the defective PRODUCT with a comparable PRODUCT, repair the defective PRODUCT, or refund the BUYER'S purchase price in exchange for the PRODUCT. Repairs or replacements are warranted for only the remainder of the original warranty period and only to the original BUYER.

Under no circumstances shall the SELLER be liable for any labor charged or travel time incurred in the diagnosis for defects, removal, or reinstallation of the PRODUCT, or any contingent expense.

Under no circumstances will the SELLER be liable for any damage or expense incurred by reason of the use or sale of the PRODUCT.

Other than expressly set forth herein, the SELLER shall in no way be responsible for the proper or improper use and service of the PRODUCT. In no event shall the SELLER be liable for any special, incidental, indirect or consequential damages of any kind or nature, whether or not the BUYER of the PRODUCT was advised of the possibility of damage or harm, arising or resulting from the use or performance of the PRODUCT and BUYER hereby waives the right to any and all such claims.

BUYER, acknowledges that he/she is not relying on SELLER'S skill or judgment to select or furnish goods suitable for any particular purpose and that SELLER has no liability that will extend beyond the scope of the LIMITED EXPRESS WARRANTY contained herein, and BUYER hereby waives all remedies or liabilities, expressed or implied, arising by operation of law or otherwise, (including, without limitation, any obligation of SELLER with respect to fitness for any particular purpose; merchantability; and special, incidental, indirect or consequential damages) or whether or not occasioned by SELLER'S negligence.

SELLER disclaims any warranty and expressly disclaims any liability for personal injury or damages related to BUYER'S use of the PRODUCT. BUYER acknowledges and agrees that the disclaimer of any liability for personal injury is a material term for this agreement and BUYER agrees to indemnify SELLER and hold SELLER harmless from any claim related to the PRODUCT and its use or performance. Under no circumstances will SELLER be liable for any damages, liabilities, costs or expenses incurred as a result of or by reason of use, performance or sale of the PRODUCT, including without limitation, any damages, liabilities, costs or expenses incurred by reason of BUYER'S negligence related to those uses of the PRODUCT.

The proper installation of the PRODUCT is the sole responsibility of the BUYER. The SELLER assumes no liability regarding improper installation or misapplication of the PRODUCT.

WARRANTY CONTINUED

SELLER hereby provides the following limited warranty as to description, quality, merchantability, fitness for the PRODUCT'S purpose, productiveness, or any other matter of SELLER'S PRODUCT sold herewith. The SELLER shall be in no way responsible for the open use and service of the PRODUCT and the BUYER hereby waives all rights other than those expressly written herein. This Warranty shall not be extended or varied except by a written instrument signed by SELLER and BUYER.

IN THE EVENT THAT THE BUYER DOES NOT AGREE WITH THIS AGREEMENT, THE BUYER MAY PROMPTLY RETURN THE PRODUCT, IN A NEW AND UNUSED CONDITION, WITH A DATED PROOF OF PURCHASE, TO THE PLACE OF PURCHASE WITHIN THIRTY (30) DAYS FROM THE DATE OF PURCHASE FOR A FULL REFUND. THE BUYER AGREES THAT THE INSTALLATION OF THIS PRODUCT CONFIRMS THE BUYER HAS READ AND UNDERSTANDS THIS AGREEMENT AND ACCEPTS THE TERMS AND CONDITIONS OF THIS AGREEMENT.

Warranty Procedure

In the unlikely event a warranty appears as if it may be warranted, the following steps are taken:

- 1 The customer discussed the symptoms of the problem with a PureFlow AirDog Technician. The customer is to have the system Serial Number and Model Number available for the Technician when the call is made. This will expedite all steps of the process.
- 2 The customer performs any and all tests requested by the PureFlow AirDog Technician. This is done to isolate the potential problem while eliminating potential installation or maintenance related issues,
- 3 If the PureFlow AirDog Technician determines based on the customer feedback concerning the requested testing that system may be at fault, the customer is advised that all returned pumps are tested upon arrival and should this returned pump perform at design criteria upon arrival, the customer will be charged a \$50.00 fee.
- 4 The PureFlow AirDog Technician will first request the customer's phone number in the event the phone call is accidentally disconnected and then transfer the customer to a PureFlow AirDog Customer Service Representative. Should a Customer Service Representative not be available, the Technician will offer the Customer the option to hold, call back, or receive a return call.
- 5 The PureFlow AirDog Customer Service Representative will check to determine if the customer's Warranty Registration Card is on file.
 - a. If no Warranty Registration is found, the customer will be required to supply the original purchase receipt showing the purchase date.
 - b. If no Warranty Registration is found, the customer will be advised of the options should the system in question is out of the default warranty period (1 year).
- 6 The PureFlow AirDog Customer Service Representative will request the customer information, including: Name, Address, Phone Number, Model Number, Serial Number, Year / Make / Model of vehicle, Name of Dealer purchased from, Purchase Date, Description of Problem, Customers' understanding of the resolution, and customer credit card information.
- 7 PureFlow AirDog will cover Ground Shipping charges to ship the replacement unit and will include a prepaid shipping label for the return of the defective unit. Any additional items ordered at the time of the replacement shipment will include their portion of the shipping cost.
- 8 A period of 15 Calendar Days from the time of shipment is provided for the receipt of the defective unit at the PureFlow AirDog facility. Failure to return ship the defective unit to arrive within the defined time period will result in a charge of \$250.00 against the customer's credit card as the purchase cost of the defective unit.

Revised January 10, 2024

