

#48



**FP-100-4G**

**FP-150-4G**

**PATENT PROTECTED:**

<https://pureflowairdog.com/p-35853-patents.html>

# **2019-CURRENT CUMMINS INSTALLATION INSTRUCTIONS**

**PLEASE READ AND CHECK CONTENTS  
BEFORE INSTALLATION**



**PUREFLOW AIRDOG  
705 W MAUSOLEUM RD.  
SHELBYVILLE, IN 46176**

**877-421-3187  
PUREFLOWAIRDOG.COM**

## TABLE OF CONTENTS

<b>TITLE</b>	<b>PAGE</b>
<b>INTRODUCTION</b>	<b>2</b>
<b>SAFETY GUIDELINES</b>	<b>3</b>
<b>PRE-INSTALLATION CHECKS</b>	<b>4</b>
<b>PARTS LIST</b>	<b>5</b>
<b>QUICK CONNECT FITTING OVERVIEW</b>	<b>6</b>
<b>QUICK CONNECT FITTING ILLUSTRATION</b>	<b>7</b>
<b>INSTALLING PUMP FITTINGS</b>	<b>8</b>
<b>PUMP CRADLE BRACKET INSTALLATION</b>	<b>9</b>
<b>PUMP TO FRAME INSTALLATION</b>	<b>10</b>
<b>FUEL LINE ASSEMBLY OVERVIEW</b>	<b>12</b>
<b>ENGINE LINE INSTALLATION</b>	<b>13</b>
<b>RETURN LINE INSTALLATION</b>	<b>15</b>
<b>INLET LINE INSTALLATION</b>	<b>16</b>
<b>WIRING INSTALLATION</b>	<b>23</b>
<b>INITIAL STARTING PROCEDURE</b>	<b>26</b>
<b>FILTER SERVICE</b>	<b>27</b>
<b>SERVICING THE PUMP GEROTOR</b>	<b>28</b>
<b>WARRANTY</b>	<b>29</b>

## INTRODUCTION

### Thank you for choosing AirDog® for your truck fueling needs!

AirDog® recommends that a certified diesel shop technician install this product. Please note, if the end user performs the installation, it is recommended they have basic knowledge on how electric fuel systems operate and function. Failure to properly set up this fuel system may result in a voided warranty. **If properly set up per these instructions, the pump head carries a lifetime warranty to the original purchaser. THIS WARRANTY IS NON-TRANSFERRABLE!**

The Original AirDog® uses a ball and spring on the return side of the pump to regulate fuel pressure. The pressure for this application is 15psi. The fuel pressure is not adjustable other than stretching the spring for higher pressure or cutting the spring for lower pressure. If a different fuel pressure is desired, call 317-421-3180 and speak to an AirDog® Technician. We may have the pressure spring you are looking for.

### OVERVIEW ON HOW THE SYSTEM OPERATES

The AirDog® draws fuel from the tank from a high flow suction tube to bypass the fuel pump in the tank. The fuel is then pulled through a water separator before being pressureized through the Gerotor pump. The pressureized fuel is sent through the 2 micron fuel filter before being sent to the factory fuel filter housing. The pump maintains pressure through a high flow ball and spring regulator behind the tank fitting in the filter base.

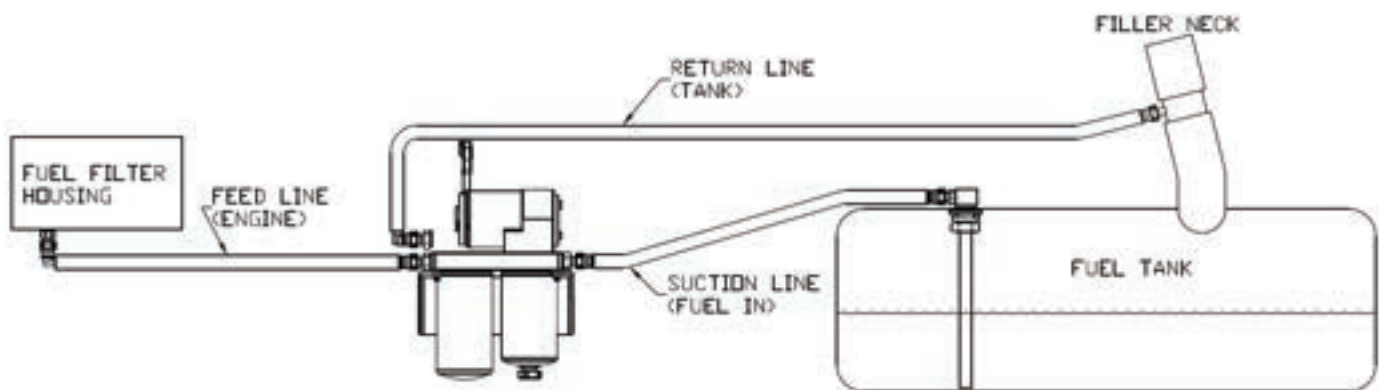

## SAFETY GUIDELINES

### **IMPORTANT!**

#### **PLEASE READ THIS INSTALLATION MANUAL CAREFULLY**

It contains important information, instructions, and necessary operating procedures. The continual observance of the operating procedures will help extend the life of the fuel system.



### **SAFETY INSTRUCTIONS**

#### LEARN TO RECOGNIZE SAFETY INFORMATION

This is the safety alert symbol. When you see this symbol in this manual, **BE ALERT TO THE POTENTIAL FOR PERSONAL INJURY!**

Follow recommended precautions and safe operating practices.

#### UNDERSTANDING SIGNAL WORDS

A signal word-**DANGER**, **WARNING**, or **CAUTION** is used with the safety alert symbol.

**DANGER** indicates a hazardous situation which, if not avoided, **WILL** result in death or serious injury.

**WARNING** indicates a hazardous situation which if not avoided, **COULD** result in death or serious injury.

**CAUTION** indicates a hazardous situation which if not avoided, **COULD** result in minor or moderate injury

**NOTICE** indicates a preferred installation procedure.



## PRE-INSTALLATION CHECKS



**WARNING: SUFFOCATION HAZARD!** Immediately discard any plastic bags and packing materials to eliminate **CHOKING HAZARDS TO CHILDREN AND ANIMALS.**

The installation of your AirDog® can be made relatively easy by following the steps outlined in this manual, and:

1. Inventory the package components completely. Notify PUREFLOW AIRDOG® immediately of any missing or damaged parts! 317-421-3180
2. Read the installation manual completely. Understand how the system operates and understand the installation recommendations before beginning the installation.
3. The installation recommendations contained herein are suggested installation guidelines only. Individual installations may vary.
4. If any installation procedure is uncertain, contact PUREFLOW® AIRDOG for technical assistance.
5. When installing the AirDog® fuel lines be sure to keep the **ORIGINAL ENGINE RETURN LINE** connected as it is from the factory!

### SAFETY GUIDELINES!



**WARNING**

Please be sure to check the vehicle's tires to prevent rolling



**WARNING**

Please use proper supports when working beneath an elevated vehicle



**CAUTION**

Most diesel pickups have two (2) 12 volt batteries. Disconnect the battery cables to both batteries before proceeding with the AirDog® installation



**WARNING**

Vehicle main frametrails should not be drilled into or welded upon.



**CAUTION**

Wear safety glasses or shield when using tools such as drills and grinders or when using a punch or chisel



**CAUTION**















Prolonged exposure to loud noise can cause impairment or loss of hearing. Wear suitable hearing protective devices such as ear muffs or ear plugs to protect against loud noises.



**CAUTION**

Use common sense when routing fuel lines and electrical wiring. Keep them away from hot exhaust components and/or moving parts. Properly secure lines to prevent chaffing.

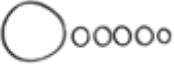
## PARTS LIST

<b>QTY</b>	<b>DESCRIPTION</b>	<b>PART NUMBER</b>	<b>IMAGE</b>
1	AirDog®	FP-100 OR FP-150	
1	AirDog® Cradle Bracket	001-3C-0004	
1	Frame Bracket Set	010-3C-0001 010-3C-0002	
1	Mounting Bracket Hardware	901-61-0102-PM	
1	Spacer Block	010-3C-0003-A-P	
1	Wiring Harness	5E-2-014-HD	
1	High Flow Suction Tube	WAP109	
1	1.5" Filler Neck Tee with Clamps	001-4A-1-0150	
1	20ft of Fuel Line	HS20	
4	1/2" Straight Hose Quick Connect Fitting	FQC12S	
2	1/2" 90deg Hose Quick Connect Fitting	FQC1290	
3	1/2" Male Quick Connect x 3/4-16 UNF ORB	08J2044-3/4UNF	
1	Zip/Cable Tie Bundle	5H-2-1-B	
1	Customer Service O-ring Kit	901-05-0101	
1	Vacuum Cap	HVC-467-16	
1	Vacuum Cap Hose Clamp	4C-2-1-10	

### WHY WE USE QUICK CONNECT FITTINGS

Almost every modern vehicle on the road uses what are called quick connect fittings for their fuel system. These are standardized using J2044 SAE specifications. We use these fittings to make the installation of our fuel systems as simple and as least invasive as possible. This allows for a simple/clean installation of our products.

### HOW THE CONNECTIONS WORK

To connect the assemblies, simply insert the male end form into the mating female connector. Push firmly until you hear it “click” into place. To disconnect the fittings, press down and hold the tabs on the female connector while you firmly pull the assembly apart.



# ILLUSTRATION OF QUICK CONNECT COMPONENTS

IMAGE NOT TO SCALE

VIEW OF PUMP IS LOOKING DOWN

THE PORTS ARE LABELED

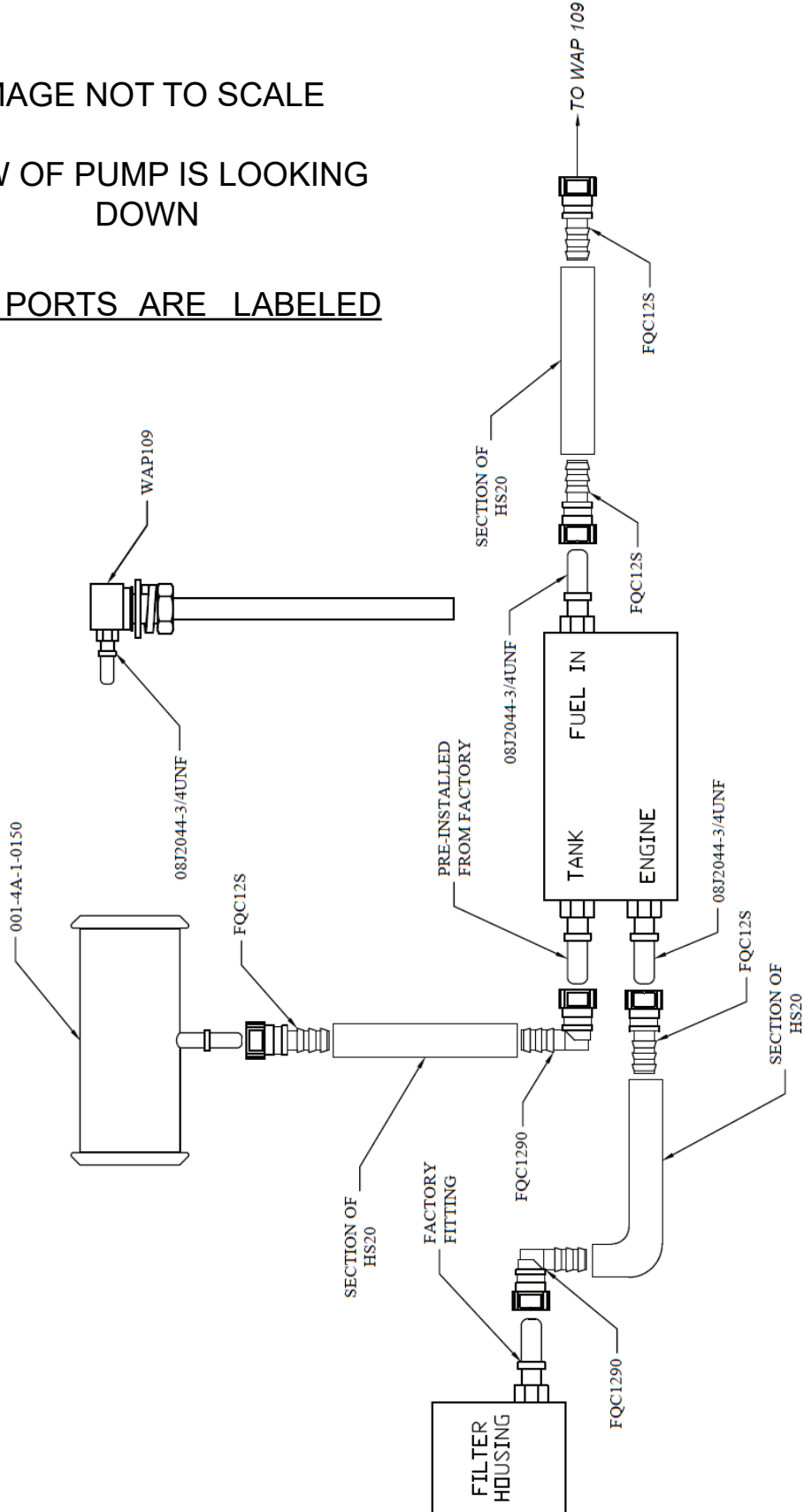



## INSTALLING THE PUMP FITTINGS

### TOOLS NEEDED:

- Torque Wrench
- 7/8" Deep Socket

### PARTS NEEDED:

- (2) 08J2044-3/4UNF fittings

- 1-1. Dip the threaded end of the 1/2" male J2044 quick connect x 3/4" UNF fittings (08J2044-3/4UNF) into clean motor oil and hand-thread into the "ENGINE" and "FUEL IN" ports in the AirDog®. Using a 7/8" deep socket, torque these fittings to 180in-lb or 15ft-lb.

**NOTICE**

DO NOT overtighten the fittings or damage may occur!



**Figure 1**

## INSTALLING THE PUMP ON THE BRACKET

### TOOLS NEEDED:

- 3/16 Allen
- 7/16 Socket or Wrench

### PARTS NEEDED:

- (4) 1/4-20 x 1.25 Socket Head Cap Screws
- (4) 1/4" Lock Washers
- (4) 1/4-20 Nuts
- (1) 001-3C-0004 Cradle Bracket

- 2-1. First, take a look under the truck and pick a location where the pump and brackets will fit. Once the location is known, orient the pump in the cradle bracket with the suction line "FUEL IN" pointed towards the fuel tank.

### NOTICE

We do recommend mounting the system on the inside of the frame if possible.

- 2-2. Using the above listed hardware, mount the AirDog to the cradle bracket in the desired orientation using a 7/16 socket and 3/16 Allen wrench.

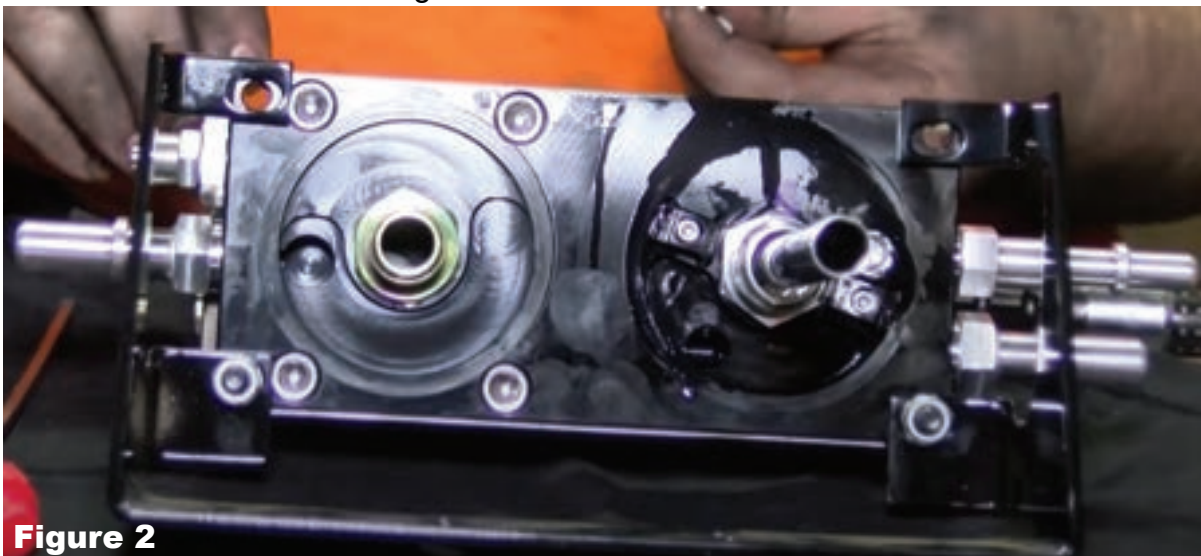

Figure 2



Figure 3

## INSTALLING THE PUMP ON THE FRAME

### TOOLS NEEDED:

- 3/16 Allen
- 1/2 Socket or Wrench
- 9/16 Socket or Wrench x2

### PARTS NEEDED:

- (4) 5/16-18 x 3.0" Flat Socket Head Cap Screws
  - (4) 5/16" Lock Washers
  - (4) 5/16-18 Nuts
  - (3) 3/8-16 x 4.5" Hex Head Cap Screw
  - (3) 3/8 Lock Washers
  - (3) 3/8-16 Nuts
  - (1) 010-3C-0001 Front Frame Sandwich Plate (Multiple Holes)
  - (1) 010-3C-0002 Back Frame Sandwich Plate
  - (1) 010-3C-0003-A-P Spacer Block
- 3-1. Mock up the Front Frame Sandwich Plate (Multiple Holes) (010-3C-0001) on the frame and hold the pump assembly up to it. Choose a set of holes that tucks the pump up as far as possible without touching the bottom of the cab and use those holes to mount the pump in the next step.



**Figure 4**

**THE PUMP IN THE PHOTO IS A 5G, BUT THE CONCEPT IS THE SAME**

## INSTALLING THE PUMP ON THE FRAME CONTINUED

- 3-2. Assemble the AirDog® mounting bracket (001-3C-0004) to the frame bracket (010-3C-0001) using the spacer (010-3C-0003-A-P) as shown in figure 3 using the four 5/16 bolts, lock washers, and nuts included in the mounting bracket hardware kit (figure 5). Using a 3/16" Allen and a 1/2" wrench, properly torque all fasteners!



**Figure 5**

- 3-3. Clamp the frame between the AirDog® bracket assembly and the backing plate using the 3/8" x 4 1/2" bolts, lock washers, and nuts included in the kit. Use two 9/16" wrenches to tighten.

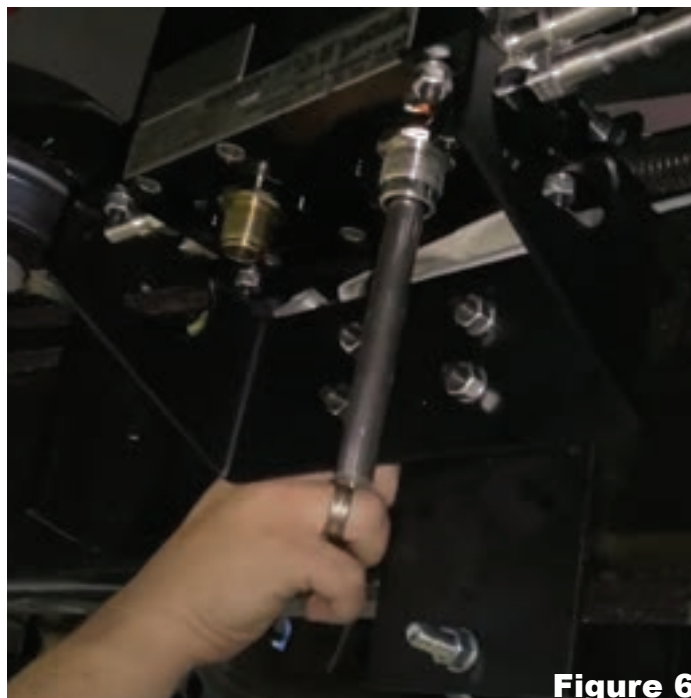

**Figure 6**

## FUEL LINE ASSEMBLY OVERVIEW

This kit includes a length of fuel line and separate fuel line fittings to allow for a much cleaner looking installation. Assemble the fuel lines as you install them.

### NOTICE

Do not pre-assemble the fuel lines, or the lengths will not be correct.

- 4-1. Take the fuel line end and lubricate the barbed end with clean motor oil (Figure 7) and press it into the fuel line (HS20) until all of the barbs are covered and the fuel line contacts the shoulder. (Figures 8 and 9). The fuel line end should look like Figure 9.



**Figure 7**

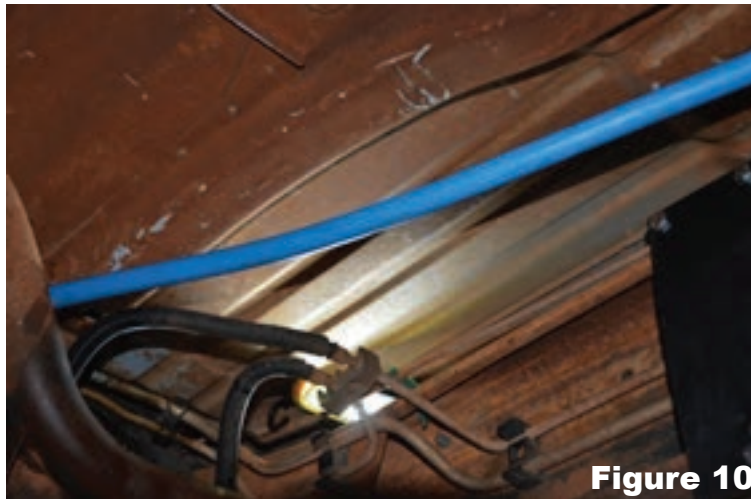

**Figure 8**



**Figure 9**

- 4-2. Now plug that fuel line with that fitting into the connection on either the AirDog® or the truck where the manual calls it out.
- 4-3. Run the fuel line along the frame away from any hot or moving parts such as exhaust or the driveshaft (Figure 10). Cut the hose to length and insert the other fuel line end that the manual calls out into the fuel line as outlined in step 4-1.



**Figure 10**

### NOTICE

Hose clamps are not needed for these push-lock connectors. They may cause damage to the hose and cause fuel leaks.

## ENGINE LINE INSTALLATION

### TOOLS NEEDED:

- Clean Motor Oil or ATF
- Hose Cutters or a way to cut Fuel Line

### PARTS NEEDED:

- (1) FQC12S 1/2" Straight Quick Connect Fitting
- (1) FQC1290 1/2" 90deg
- (1) HS20 20ft Fuel Line

### NOTICE

When installing the AirDog® fuel system, it is recommended to connect it to the factory filter housing to utilize the Cummins Nano-Net Fuel Filter in conjunction with our 2 micron fuel filter.

- 5-1. Disconnect the factory fuel filter housing fitting as pictured in figure 11.



**Figure 11**

- 5-2. Assemble one end of the hose (Reference section 4) using Fuel line end FQC1290 and plug it into the factory filter housing to where the factory fitting was removed in the previous step. A “click” will be heard once the fitting is properly connected.



**Figure 12**

## ENGINE LINE INSTALLATION CONTINUED

- 5-3. Run the fuel line along the frame as mentioned in step 4-3 to the “Engine” port in the AirDog®. Cut the fuel line to length and insert fuel line end FQC12S per step 4-1. Once the connector is installed, connect it to the male J2044 fitting in the “Engine” port in the AirDog®. A “click” will be heard once properly connected.

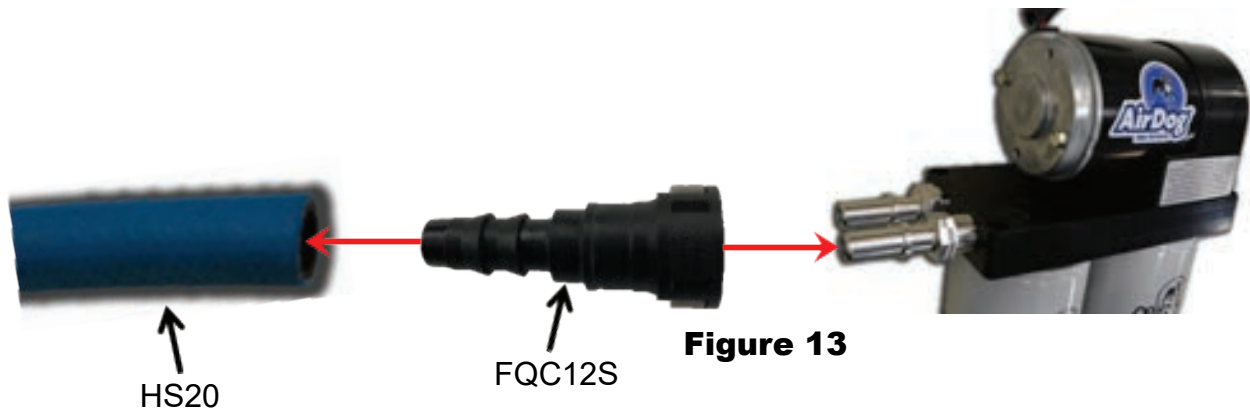

## RETURN LINE INSTALLATION

### TOOLS NEEDED:

- Clean Motor Oil or ATF
- Hose Cutters or a way to cut Fuel Line and the Filler Neck

### PARTS NEEDED:

- (1) 001-4A-1-0150 1.5" Filler Neck Return Tee with Clamps
- (1) FQC1290 1/2" 90deg Quick Connect Fitting
- (1) FQC12S 1/2" Straight Quick Connect Fitting
- (1) HS20 20ft Fuel Line

- 6-1. Cut the filler tube as illustrated in figure 14. Loosely assemble clamps on each end of filler tube before the return tee (001-4A-1-0150) is pushed in. Install the filler return tee with the arrows pointing towards the fuel tank (figure 15). Failure to do so will cause fuel to spray up the filler tube and not down it. The finished product should look like figure 16.

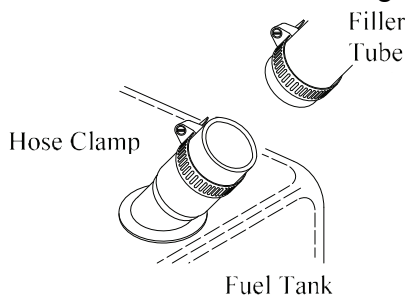

**Figure 14**

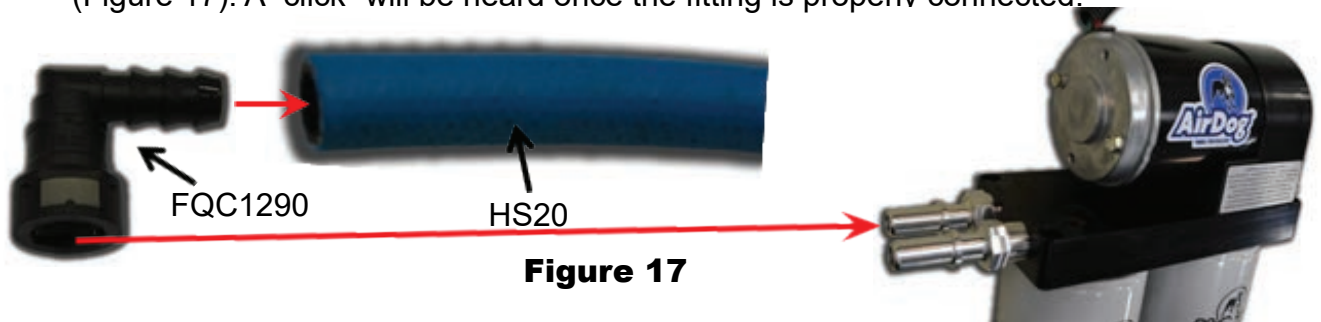

**Figure 15**



**Figure 16**

- 6-2. Assemble one end of the hose (Reference section 4) using Fuel line end FQC1290 and plug it into the "Return" J2044 fitting installed in the AirDog® (Figure 17). A "click" will be heard once the fitting is properly connected.



**Figure 17**

- 6-3. Run the fuel line along the frame as mentioned in step 4-3 to the filler neck tee. Cut the fuel line to length and insert fuel line end FQC12S per step 4-1. Once the connector is installed, connect it to the male J2044 fitting in the filler neck tee (001-4A-1-0150). A "click" will be heard once properly connected.



**Figure 18**



## INLET LINE INSTALLATION

### TOOLS NEEDED:

- Clean Motor Oil or ATF
- Hose Cutters or a way to cut Fuel Line
- 1" Hole Saw or Step Bit that can go up to 1"
- Hammer
- Large Screwdriver
- 7/8" Wrench or Deep Socket
- Tape Measure
- Permanent Marker
- Small Pilot Drill Bit
- 1/2" Drill Bit
- Cut-Off Wheel or Saw
- 1.5" Wrench or Adjustable Wrench

### PARTS NEEDED:

- (2) FQC12S 1/2" Straight Quick Connect Fitting
- (1) WAP109 High Flow Suction Tube
- (1) HS20 20ft Fuel Line
- (1) 08J2044-3/4UNF

- 7-1. Assemble one end of the suction fuel line (reference section 4) using fuel line end FQC12S. Once the end is pressed in, connect it to the J2044 fitting in the "Fuel In" port on the AirDog®. A "click" will be heard when the fitting is properly connected.

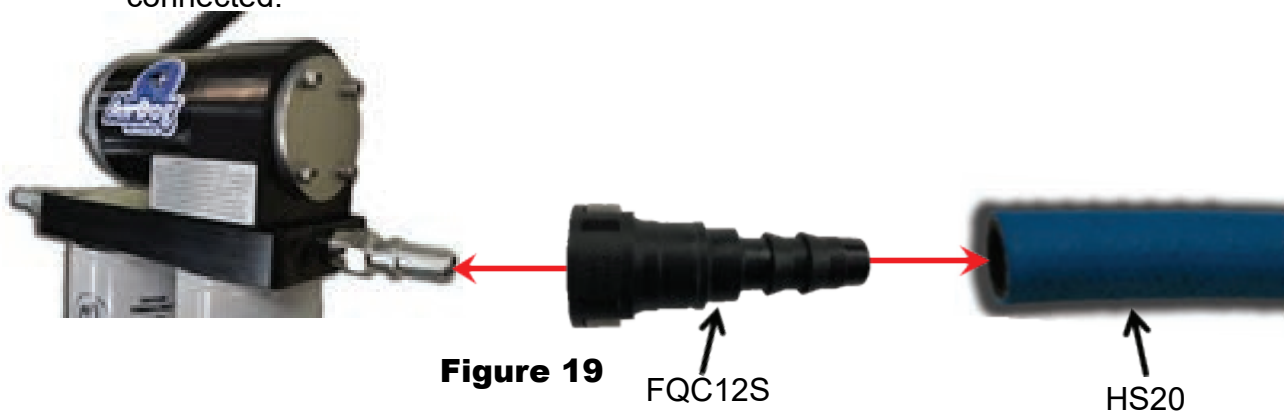

## INLET LINE INSTALLATION CONTINUED

### NOTICE

This pump **REQUIRES** the installation of this high flow suction tube or aftermarket sump! Failure to do so **WILL** cause pump failure and may void your warranty!

- 7-2. To install the WAP109, you will need to either drop the fuel tank or remove the truck bed.

### NOTICE

Should you choose to drop the fuel tank, support the tank as it is when it is installed on the truck. If you let it rest flat on the floor, the tank may squash out and the suction tube will be too short after the tank is re-installed in the truck. The suction tube, being cut too short may suck air as the fuel drops below  $\frac{1}{4}$  tank level.



**WARNING:** Failure to use proper jack stands while working under a vehicle may result in **SERIOUS INJURY OR DEATH!**



**CAUTION:** Failure to properly support the fuel tank upon removal/installation, may result in **INJURY!**



Figure 20



Figure 21



Figure 22

## INLET LINE INSTALLATION CONTINUED

### NOTICE

Should you choose to pull the pickup bed to access the tank. Be sure to disconnect the tail light wires, fuel tank filler tube, and any other accessories or components that may be secured to the frame and bed.



**WARNING:** Failure to use proper jack stands while working under a vehicle may result in **SERIOUS INJURY OR DEATH!**



**WARNING:** Failure to properly secure the bed while being removed/installed, may result in **SERIOUS INJURY OR DEATH!**



**Figure 23**



**Figure 24**

### NOTICE

The fuel tank and truck bed used for the pictures are examples only and may not be exactly the same as your tank.

## INLET LINE INSTALLATION CONTINUED

### NOTICE

**IMPORTANT!** Select a location for the suction tube that has adequate clearance below the bed. Also consider that under hard acceleration, fuel will migrate toward the back of the fuel tank.

- 7-3. Once either the tank has been dropped or the bed removed, remove the collection basket as shown in figures 25 and 26 using a hammer and large screwdriver to remove the retaining ring.



**Figure 25**



**Figure 26**

- 7-4. Select a spot to install the WAP109 draw straw. Be sure no bed supports or any cross members will contact the bulkhead fitting once the bed or tank is reinstalled. Drill a 1" hole using a 1" hole saw or step bit in your selected location (Figure 27). Hold a container below the drill point to catch debris as shown in figure 28.



**Figure 27**



**Figure 28**

## INLET LINE INSTALLATION CONTINUED

- 7-5. Install fitting 08J2044-3/4UNF into the bulkhead fitting of the WAP109 draw straw, as shown, using a 7/8" wrench or deep socket. Tighten until the O-ring is no longer visible.



**Figure 29**

- 7-6. Mock the suction tube in the fuel tank and measure from the top of the fuel tank to the bottom of the green seal (Figure 30). Take this measurement and add a 1/4 inch. Measure from the bottom of the tube and mark the previous measurement as shown (Figure 31). The added 1/4" will ensure the bottom of the straw is against the bottom of the tank once reinstalled.

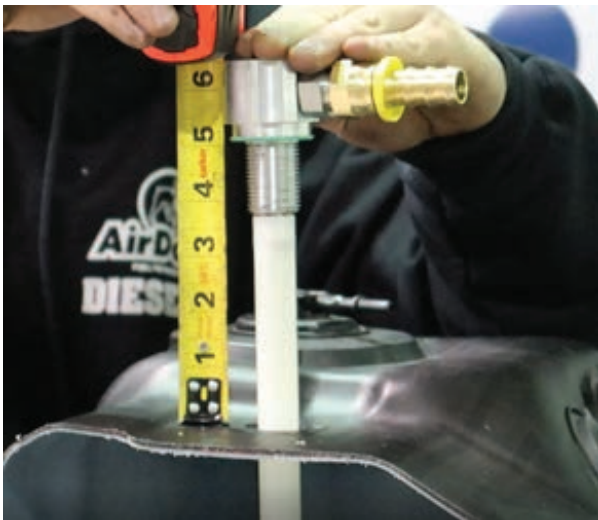

**Figure 30**



**Figure 31**

## INLET LINE INSTALLATION CONTINUED

- 7-7. Drill crossing pilot holes through the nylon tube, centered on the marked line, as shown (Figure 32). Use a larger bit (1/2" MAX) to open the holes up (Figure 33).



**Figure 32**



**Figure 33**

- 7-8. Cut the fuel tube to the measured length (Figure 34). Deburr the tube (Figure 35) to be sure no debris get pulled into the fuel pump.



**Figure 34**

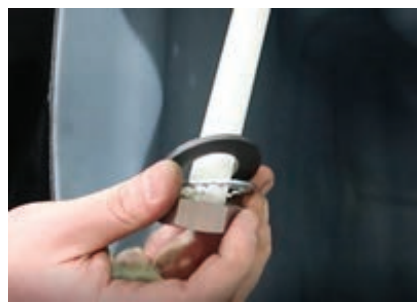

**Figure 35**

- 7-9. Install the trimmed WAP109 into the previously drilled hole in the tank and orient it in the desired direction (Figure 36). Make sure the bottom of the straw is contacting the bottom of the fuel tank. Install the hardware in this order: washer, lock washer, nut. Tighten the nut with a 1.5" wrench or adjustable wrench till snug (Figure 38). (Tank Cutaway is for reference. Access to straw is through module hole.)



**Figure 36**



**Figure 37**



**Figure 38**

## INLET LINE INSTALLATION CONTINUED

- 7-10. Re-install the fuel module. Re-install the factory return line (The smaller of the two lines) to the proper port of the fuel module before the tank or bed is fully re-installed.

### NOTICE

The factory engine return line **MUST** be reconnected to the fuel module! The factory engine feed port can be capped off with a vacuum cap.



**Figure 39**

- 7-11. Run the fuel line along the frame as mentioned in step 4-3 to Suction Tube (WAP109). Cut the fuel line to length and insert fuel line end FQC12S per step 4-1. Once the fuel line end is pressed in, press it onto the quick connect fitting in the WAP109. A "Click" will be heard once properly connected.



**Figure 40**

- 7-12. Since the factory suction line is no longer used, cap the factory suction line with the supplied vacuum cap (P/N HVC-467-16) and hose clamp (P/N 4C-2-1-10)



**Figure 41**

## WIRING INSTALLATION

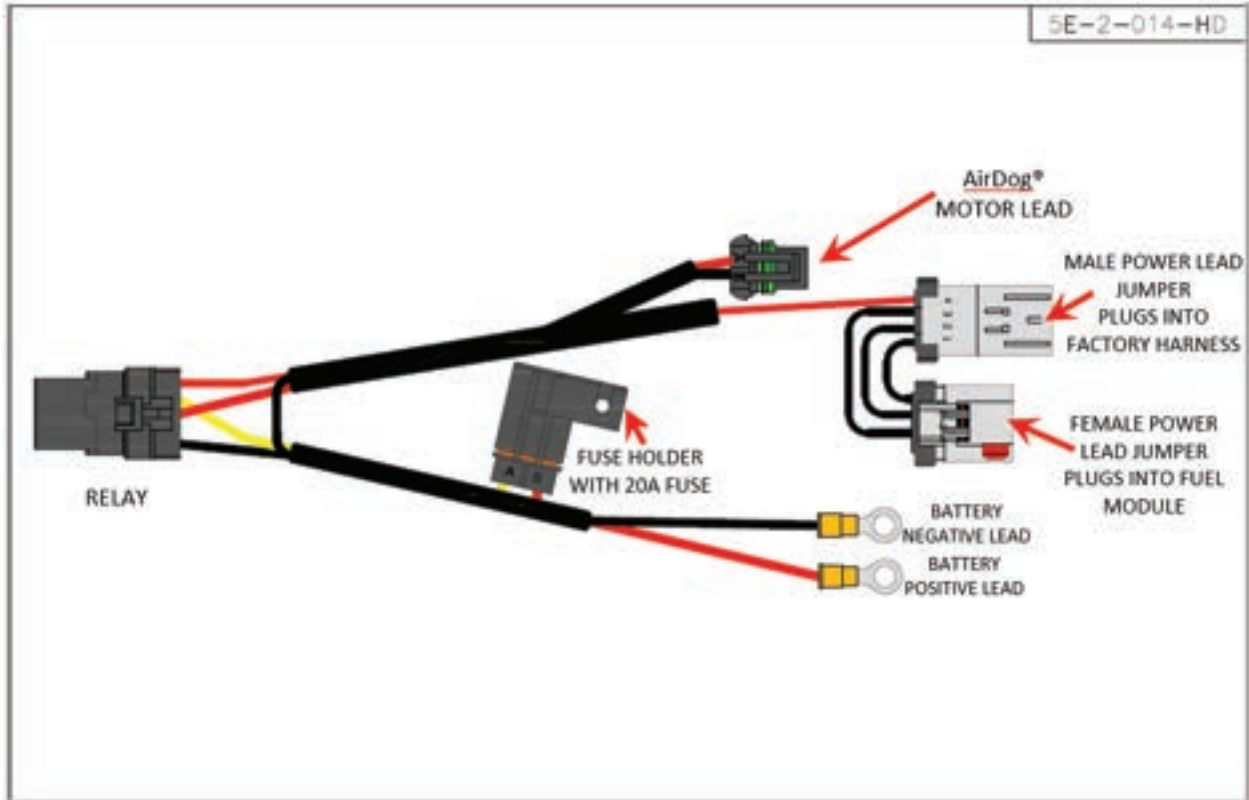

**Figure 42**

- 8-1. Secure the relay and fuse holder to the vehicle. Be sure to route the wires away from any moving parts. The relay is illustrated below in figure 43. The fuse holder mounting is the same concept.

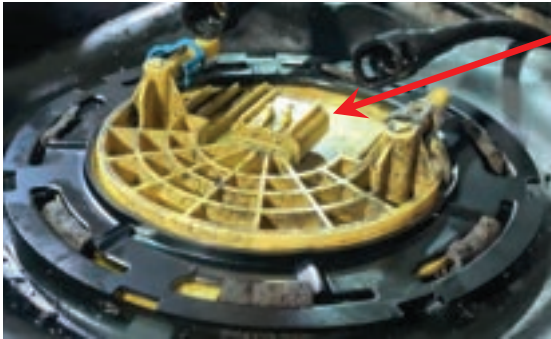

**Figure 43**



## WIRING INSTALLATION CONTINUED

- 8-2. Disconnect the OE fuel pump lead from the top of the fuel module (Figure 44) and plug in the AirDog® harness female power lead jumper (Figure 45).



**Figure 44**

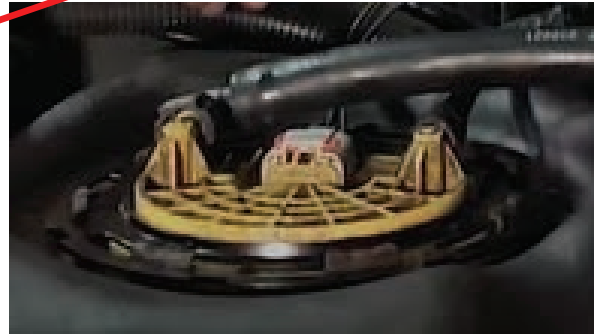

**Figure 45**

- 8-3. Plug the AirDog® harness Male power lead jumper into the truck side harness connector (Figures 46 and 47). This will use the factory pump power as a trigger for the relay in the AirDog® harness while retaining the fuel level sensor.



**Figure 46**



**Figure 47**

### NOTICE

Connecting the power supply leads to the alternator instead of the battery will create a corrosion resistant connection.

- 8-3. Route the Red and Black power supply leads to the alternator. Connect the Black (-) lead to the alternator Chassis Ground connection. Connect the Red (+) lead to the alternator Hot Lead going to the battery.

Black (-)

Red (+)



**Figure 48**

## WIRING INSTALLATION CONTINUED

- 8-4. Should you choose to connect the power supply leads directly to the battery, connect the Red (+) lead to the Positive (+) post of the driver's side battery. Connect the Black (-) lead to the Negative (-) post of the same battery.

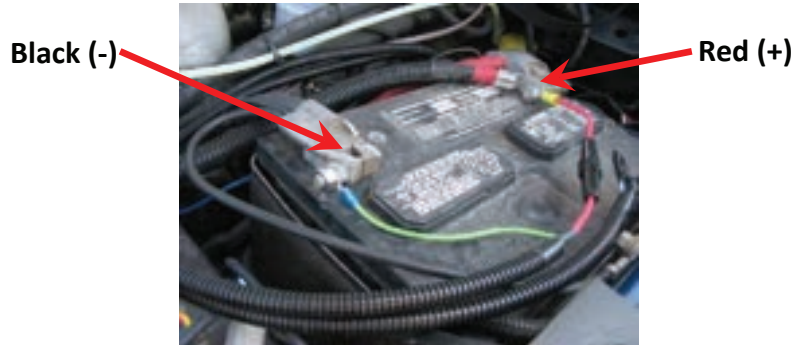

**Figure 49**

- 8-5. Route the wiring harness to the AirDog® and connect the 2 pin Metri-Pack connector to the corresponding connector on the AirDog®.

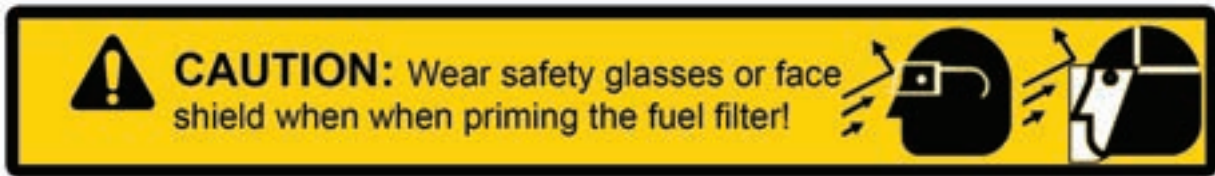

**Figure 50**

## INITIAL STARTING PROCEDURE

The AirDog® is a self-priming system, however, to prevent potential damage to the system, it is recommended to fill the pre-filter with diesel fuel before initial startup.

- 9-1. Fill the water separator with clean diesel fuel.
- 9-2. Turn the starter key to the on/run position.
- 9-3. While the AirDog® is operating, bleed the air from the fuel line to the engine by loosening the fuel line connection at the engine fitting. As soon as the line is purged of air and pure fuel is observed, properly tighten the fuel fitting.



NOTE: put a rag or shop towel over and around fitting to prevent splatter. Catch all spilled fuel and dispose of properly.

- 9-4. Start the engine!

RECHECK ALL FUEL FITTINGS FOR LEAKAGE AND PROPERLY TORQUE. BE SURE ALL FUEL LINES ARE PROPERLY ROUTED TO PROTECT FROM EXCESSIVE HEAT AND SECURED TO PROTECT FROM CHAFFING AND ABRASION. RECHECK ALL ELECTRICAL LINES, SECURE AS NECESSARY.

Checking Pump Noise!

NOTE: Each AirDog® has been manufactured in a Quality Controlled process and fully tested for operation and performance before shipment. This is a smooth running system. However, if any fuel fitting on the vacuum side, between the fuel tank and the AirDog® or the pre-filter, has been left loose during the installation process, the system may suck air at an excessive rate and will be very noisy. To check for this problem, unscrew the pre-filter 3 or 4 full turns and activate the AirDog® by turning the ignition switch to on. If the AirDog® runs quietly, then excessive air from a loose fitting or leaking pre-filter seal is most likely the reason for the excessive noise. Correct as necessary.

- A. The seal groove in the pre-filter is a snug fit and on occasion the seal has been found to not be fully seated. Remove the pre-filter, remove the seal from the top of the nut plate. Clean and lubricate the seal groove. Carefully replace the seal in the groove. Be sure to fully seat the seal.
- B. Check the fittings, especially the quick connect at the tank.

## FILTER SERVICE RECOMMENDATIONS

Plugging of either the fuel filter or the water separator itself will cause low fuel pressure and low flow to the engine. If a low fuel pressure issue exists, replace the fuel filter. Typical fuel filter life is 15-20k miles depending on fuel quality.



### The Water Separator

Replace the water separator every other time you change the Fuel Filter or if it becomes damaged or plugged. It is suggested to check/drain the water separator every three months or as needed should you experience excessive 'water in fuel' conditions. When installing the water separator, be sure to clean the underside of the AirDog® base. Follow the instructions printed on the pre-filter for proper tightening procedures.

NOTE: Be extremely careful to prevent any contaminants or debris from entering the pre-filter when removing it for cleaning! Large debris will jam the Gerotor and cause the fuse to blow. This is not a warranty item. Should this happen, you can easily put the system back into working order. See the instructions on "How to clean the Gerotor" for proper procedures.

### The Fuel Filter

Remove the fuel filter by turning it counter clockwise. Do not pre-fill the fuel filter with fuel. The AirDog® will fill the filter and prime the system automatically. Follow the instructions on the filter for proper tightening procedures.

NOTE: Dispose of waste fuel and used filters properly to protect OUR environment!

## SERVICING THE PUMP GEROTOR

### CLEANING DEBRIS/CHECKING FOR DAMAGE IN/TO THE GEROTOR ASSEMBLY

**STEP 1:** Remove the four (4) socket head cap screws that secure the Gerotor cap using a 3/16 allen wrench.

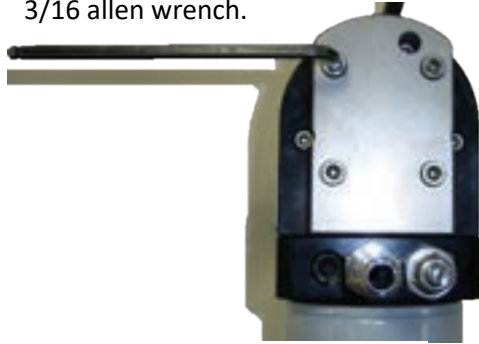

**STEP 2:** Carefully remove the O-rings you will need to reuse them.



**STEP 3:** Remove and clean the Gerotor. Be very careful to not damage the Gerotor.

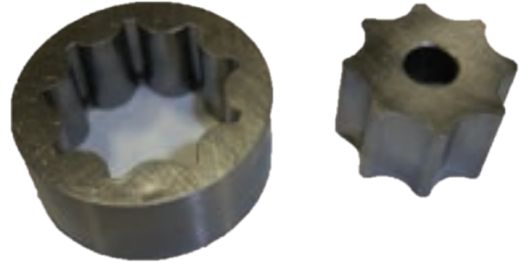

**STEP 4:** Remove the O-rings and clean/inspect the inside of the Gerotor pocket.

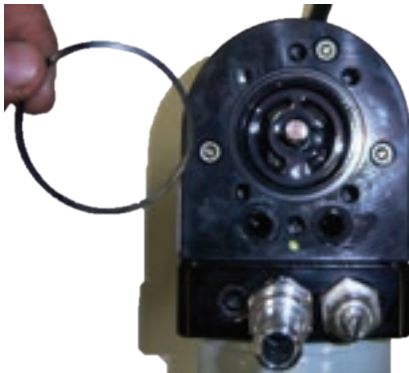

**STEP 5:** Reinstall the center gear.



**STEP 6:** Align and install the outer gear and O-rings.



**STEP 7:** Install the Gerotor Cap. Be very careful not to dislodge or pinch the O-rings.



**STEP 8:** Loosen assemble the cap screws. Torque the cap screws in an opposing pattern.

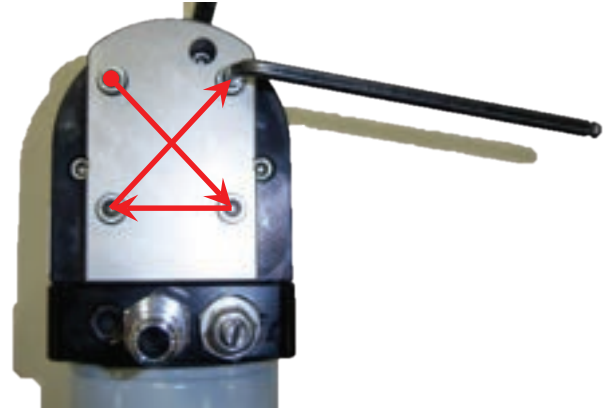

If there is damaged found to either the Gerotor, Gerotor pocket, or O-rings, call into AirDog® Tech Support for further assistance.

## **WARRANTY**

### **PUREFLOW AIRDOG LIFETIME LIMITED EXPRESS WARRANTY FOR Covered PureFlow AirDog I, II and Raptor Systems**

#### **IMPORTANT NOTICE**

**TO ACTIVATE YOUR PUREFLOW AIRDOG WARRANTY, YOU MUST COMPLETE AND MAIL YOUR WARRANTY CARD TO PUREFLOW AIRDOG WITH A COPY OF YOUR ORIGINAL SALES RECEIPT WITHIN 30 DAYS OF PURCHASE. FAILURE TO COMPLETE AND SUBMIT YOUR WARRANTY CARD WILL RESULT IN A WARRANTY PERIOD OF THE COVERED PRODUCT TO ONE (1) YEAR FROM THE DATE OF PURCHASE.**

PureFlow AirDog (hereafter collectively, "SELLER") warrants and guarantees only to the Original Purchaser (hereafter collectively, BUYER) that All PureFlow AirDog Systems (hereafter collectively, PRODUCT) shall be free from defects of materials and workmanship in the manufacturing process for as long as the BUYER owns the PRODUCT.

The Lifetime Limited Express Warranty is limited to the PRODUCT purchased by the original BUYER of the PRODUCT and limited solely to the parts contained within the PRODUCT and EXCLUDES ALL ELSE INCLUDING FILTERS AND WATER SEPARATORS. Any PRODUCT that is in question of Warranty must be returned, shipped prepaid, to PureFlow AirDog. All Warranty claims are subject to the approval of PureFlow AirDog. If it is determined that a Warranty claim exists, PureFlow AirDog will, at its sole discretion, replace the defective PRODUCT with a comparable PRODUCT, repair the defective PRODUCT, or refund the BUYER'S purchase price in exchange for the PRODUCT. Repairs or replacements are warranted for only the remainder of the original warranty period and only to the original BUYER.

Under no circumstances shall the SELLER be liable for any labor charged or travel time incurred in the diagnosis for defects, removal, or reinstallation of the PRODUCT, or any contingent expense.

Under no circumstances will the SELLER be liable for any damage or expense incurred by reason of the use or sale of the PRODUCT.

Other than expressly set forth herein, the SELLER shall in no way be responsible for the proper or improper use and service of the PRODUCT. In no event shall the SELLER be liable for any special, incidental, indirect or consequential damages of any kind or nature, whether or not the BUYER of the PRODUCT was advised of the possibility of damage or harm, arising or resulting from the use or performance of the PRODUCT and BUYER hereby waives the right to any and all such claims.

BUYER, acknowledges that he/she is not relying on SELLER'S skill or judgment to select or furnish goods suitable for any particular purpose and that SELLER has no liability that will extend beyond the scope of the LIMITED EXPRESS WARRANTY contained herein, and BUYER hereby waives all remedies or liabilities, expressed or implied, arising by operation of law or otherwise.(including, without limitation, any obligation of SELLER with respect to fitness for any particular purpose; merchantability; and special, incidental, indirect or consequential damages) or whether or not occasioned by SELLER'S negligence.

SELLER disclaims any warranty and expressly disclaims any liability for personal injury or damages related to BUYER'S use of the PRODUCT. BUYER acknowledges and agrees that the disclaimer of any liability for personal injury is a material term for this agreement and BUYER agrees to indemnify SELLER and hold SELLER harmless from any claim related to the PRODUCT and its use or performance. Under no circumstances will SELLER be liable for any damages, liabilities, costs or expenses incurred as a result of or by reason of use, performance or sale of the PRODUCT, including without limitation, any damages, liabilities, costs or expenses incurred by reason of BUYER'S negligence related to those uses of the PRODUCT.

The proper installation of the PRODUCT is the sole responsibility of the BUYER. The SELLER assumes no liability regarding improper installation or misapplication of the PRODUCT.

## WARRANTY CONTINUED

SELLER hereby provides the following limited warranty as to description, quality, merchantability, fitness for the PRODUCT'S purpose, productiveness, or any other matter of SELLER'S PRODUCT sold herewith. The SELLER shall be in no way responsible for the open use and service of the PRODUCT and the BUYER hereby waives all rights other than those expressly written herein. This Warranty shall not be extended or varied except by a written instrument signed by SELLER and BUYER.

IN THE EVENT THAT THE BUYER DOES NOT AGREE WITH THIS AGREEMENT, THE BUYER MAY PROMPTLY RETURN THE PRODUCT, IN A NEW AND UNUSED CONDITION, WITH A DATED PROOF OF PURCHASE, TO THE PLACE OF PURCHASE WITHIN THIRTY (30) DAYS FROM THE DATE OF PURCHASE FOR A FULL REFUND. THE BUYER AGREES THAT THE INSTALLATION OF THIS PRODUCT CONFIRMS THE BUYER HAS READ AND UNDERSTANDS THIS AGREEMENT AND ACCEPTS THE TERMS AND CONDITIONS OF THIS AGREEMENT.

### Warranty Procedure

In the unlikely event a warranty appears as if it may be warranted, the following steps are taken:

- 1 The customer discussed the symptoms of the problem with a PureFlow AirDog Technician. The customer is to have the system Serial Number and Model Number available for the Technician when the call is made. This will expedite all steps of the process.
- 2 The customer performs any and all tests requested by the PureFlow AirDog Technician. This is done to isolate the potential problem while eliminating potential installation or maintenance related issues,
- 3 If the PureFlow AirDog Technician determines based on the customer feedback concerning the requested testing that system may be at fault, the customer is advised that all returned pumps are tested upon arrival and should this returned pump perform at design criteria upon arrival, the customer will be charged a \$50.00 fee.
- 4 The PureFlow AirDog Technician will first request the customer's phone number in the event the phone call is accidentally disconnected and then transfer the customer to a PureFlow AirDog Customer Service Representative. Should a Customer Service Representative not be available, the Technician will offer the Customer the option to hold, call back, or receive a return call.
- 5 The PureFlow AirDog Customer Service Representative will check to determine if the customer's Warranty Registration Card is on file.
  - a. If no Warranty Registration is found, the customer will be required to supply the original purchase receipt showing the purchase date.
  - b. If no Warranty Registration is found, the customer will be advised of the options should the system in question is out of the default warranty period (1 year).
- 6 The PureFlow AirDog Customer Service Representative will request the customer information, including: Name, Address, Phone Number, Model Number, Serial Number, Year / Make / Model of vehicle, Name of Dealer purchased from, Purchase Date, Description of Problem, Customers' understanding of the resolution, and customer credit card information.
- 7 PureFlow AirDog will cover Ground Shipping charges to ship the replacement unit and will include a prepaid shipping label for the return of the defective unit. Any additional items ordered at the time of the replacement shipment will include their portion of the shipping cost.
- 8 A period of 15 Calendar Days from the time of shipment is provided for the receipt of the defective unit at the PureFlow AirDog facility. Failure to return ship the defective unit to arrive within the defined time period will result in a charge of \$250.00 against the customer's credit card as the purchase cost of the defective unit.

Revised January 10, 2024